



Parts for Trucks, Trailers & Buses

7

CHASSIS

*Proven, reliable and
always innovative.*

TRP® offers reliable
aftermarket products
that are designed
and tested to exceed
customers' expectations
regardless of the vehicle
make, model or age.



FENDERS • SUSPENSION & RIDE CONTROL •
WHEEL END



Tested. Reliable. Guaranteed.

Chassis

Choosing the right replacement part or service for your vehicle—whether you own one, or a fleet—is one of the most important decisions you can make for your business. And, with tested TRP® parts it’s an easy decision.

Regardless of the make you drive, TRP® quality replacement parts are engineered to fit your truck, trailer or bus. Choose the parts that give you the best value for your business. Check them out at an approved TRP® retailer near you.

The cross reference information in this catalog is based upon data provided by several industry sources and our partners. While every attempt is made to ensure the information presented is accurate, we bear no liability due to incorrect or incomplete information.

Product Availability

Due to export restrictions and market demands, not all products are always available in every location. Check for availability in your area with your local TRP® Distributor.

No part of this marketing material may be reproduced in any manner without written permission from TRP® North America.

TABLE OF CONTENTS

CHASSIS

FENDERS

- Poly - Half Fenders.....7-5
- Poly - Full Fenders7-6
- Poly - Single Axle Fenders7-7
- Super Single - Half Fenders7-9
- Super Single - Full Fenders.....7-9
- Super Single - Quarter Fenders7-11
- Half Fenders.....7-13
- Full Fenders7-17
- Single Axle Fenders7-21
- Quarter Fenders7-26
- Fender Mounting Kits7-29
- Top Flap for Quarter Fender.....7-39
- Mudflap Hangers7-40

TRP® North America

750 Houser Way N.
Renton, WA 98057

www.trpparts.com

SUSPENSION & RIDE CONTROL

Air Springs Application Table	7-43
Cab, Sleeper & Seat Air Springs	7-120
Cross Reference for Air Springs	7-121
Cross Reference for Bellows	7-131
Shock Application & Model Info	7-136
Shock Dimensional Info	7-239
Cross Reference for Shocks	7-242
Height Control Valve Assembly	7-275
Cross Reference for Height Control Valve Assembly	7-276
Trailer Leaf Springs	7-278

WHEEL END

Aluminum Wheels	7-281
Steel Wheels	7-281
Wheel Bearings	7-283
Wheel End Hardware	7-287
Cross Reference For Wheel End Hardware	7-296
Drive Axle Wheel Seals	7-299
Front Axle Wheel Seals	7-300
Trailer Axle Wheel Seals	7-300



FENDERS: HALF & FULL BLACK POLY

STANDARD

FEATURES & BENEFITS

- " Lightweight fenders reduce overall vehicle weight
- " Fits all standard applications for an easy install
- " Stippled grain protects against scratching and marring
- " Chemical and corrosion resistant
- " Rigid construction
- " UV-resistant medium density polyethylene



TRACTOR

FEATURES & BENEFITS

- " Lightweight
- " Durable, excellent against impact
- " UV-resistant
- " Protects against scratching and marring
- " Three-rib, medium density polyethylene



CROSS REFERENCE

TRP®	Description
SA00043	Fender, Tandem, Single Axle
HF00083	Fender, Tandem, Tractor, Single Axle
FF00103	Fender, Tandem, Full, Tractor
SA00083	Fender, Tandem, Single Axle



Scan the code for more information.
 Get the free mobile app at <http://gettag.mobi>

POLY FENDERS

Fender Mounting
See Page 7-29



HALF FENDERS (TANDEM) - POLY (PAIR)



Table 7-1: Fenders - Half Tandem Fenders (Tandem) - Poly (Pair)

Part No.	Description
HF00073	66-1/2" Half Fender, 25" Front Drop, 41-1/2" Flat, 3" Flange, Black Polyethylene, Ribbed, Pair

HALF FENDERS (TANDEM) - POLY (SINGLE)



Table 7-2: Fenders - Half Tandem Fenders (Tandem) - Poly (Single)

Part No.	Description
HF00083	66-1/2" Half Fender, 25" Front Drop, 41-1/2" Flat, 3" Flange, Black Polyethylene, Ribbed, Single

FULL FENDERS (TANDEM) - POLY RIBBED (PAIR)



Table 7-3: Fenders - Full Tandem Poly Fenders - Ribbed (Pair)

Part No.	Description
FF00103	132" Full Fender, 35" Front Drop, 62" Flat, 35" Rear Drop, Black Polyethylene, Ribbed, Pair

FULL FENDERS (TANDEM) - POLY RIBBED (SINGLE)



Table 7-4: Fenders - Full Drop Tandem Fenders - Poly Ribbed (Single)

Part No.	Description
FF00113	132" Full Fender, 35" Front Drop, 62" Flat, 35" Rear Drop, Black Polyethylene, Ribbed, Single

SINGLE AXLE FENDERS - POLYETHYLENE (PAIR)



Table 7-5: Fenders - Single Axle Fenders - Polyethylene (Pair)

Part No.	Description
SA00043	76" Single Axle Fender, Black Polyethylene, Pair, 21 lbs.

SINGLE AXLE FENDERS - POLYETHYLENE (SINGLE)



Table 7-6: Fenders - Single Axle Fenders - Polyethylene (Single)

Part No.	Description
SA00053	76" Single Axle Fender, Black Polyethylene, Single, 10-1/2 lbs.



FENDERS

FEATURES & BENEFITS

- " Stainless steel mounting arms in a paddle style
- " 16-gauge stainless steel
- " Popular 2" rolled edge



SUPER SINGLE KITS

Half Mount Super Single Kit



Full Round Mount Super Single Kit

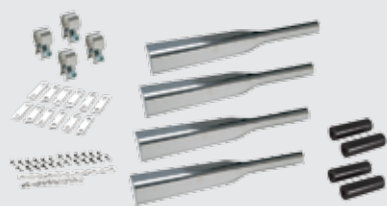

SUPER SINGLE FENDERS

TRP® Super Single Fenders measure 19" and are available in quarter fender, half tandem, full tandem and single axle configurations. Due to the reduced width of this TRP® line, specific brackets are available to mount TRP® Super Single Fenders. Kits cover all available styles and mount one pair of fenders.

TRP®	Description	UM
FF00371	Full Round, 3 Rib	PR
FF00381	Full Round, 3 Rib	EA
FF00391	Full Round, Smooth	PR
FF00401	Full Round, Smooth	EA
HF00511	Half Tandem, Smooth	PR
HF00541	Half Tandem, Smooth	EA
HF00531	Half Tandem, 3 Rib	EA
HF00521	Half Tandem, 3 Rib	PR
FF00411	Full Tandem, Smooth	PR
FF00421	Full Tandem, Smooth	EA
FB00701	Mounting Arm	EA
FB00715	Center Bracket, (1 Pc)	EA
FB00681	Half Mount Kit	EA
FB00721	Tandem Mount Kit	EA
FB00691	Full Round Mount Kit	EA
QT00261	31" Smooth Quarter Fender	PR



Scan the code for more information.
Get the free mobile app at <http://gettag.mobi>

SUPER SINGLE FENDERS

HALF FENDERS (TANDEM) - SUPER SINGLE - SMOOTH



Table 7-7: Fenders - Half Fenders (Tandem) - Super Single - Smooth

Part No.	Description
HF00511	Half Tandem Super Single, Stainless Steel, Smooth, 62" L x 19"W
HF00541	Half Tandem Super Single, Stainless Steel, Smooth, 62" L x 19"W

FULL FENDERS (TANDEM) - SUPER SINGLE - SMOOTH



Table 7-8: Fenders - Full Fenders (Tandem) - Smooth Super Single

Part No.	Description
FF00411	Full Tandem Super Single, Stainless Steel, Smooth, 103" x 19"W
FF00421	Full Tandem Super Single, Stainless Steel, Smooth, 103" x 19"W

FULL FENDERS - SUPER SINGLE - SMOOTH



Table 7-9: Fenders - Full Fenders - Smooth Super Single

Part No.	Description
FF00391	Full Round Super Single, Smooth, Stainless Steel, 80" L x 19" W
FF00401	Full Round Super Single, Smooth, Stainless Steel, 80" L x 19" W

HALF FENDERS (TANDEM) - SUPER SINGLE - 3-RIB



Table 7-10: Fenders - Half Fenders (Tandem) - Super Single - 3-Rib

Part No.	Description
HF00521	Half Tandem Super Single, 3 Rib, Stainless Steel, 60" L x 19"W
HF00531	Half Tandem Super Single, 3 Rib, Stainless Steel, 60" L x 19"W

FULL FENDERS - SUPER SINGLE - 3-RIB



Table 7-11: Fenders - Full Fenders - 3-Rib Super Single

Part No.	Description
FF00371	Full Round Super Single, 3 Rib, Stainless Steel, 80" L x 19" W
FF00381	Full Round Super Single, 3 Rib, Stainless Steel, 80" L x 19" W

QUARTER FENDERS - SUPER SINGLE

Table 7-12: Fenders - Quarter Fenders - Super Single

Part No.	Description
QT00261	31" Quarter Fender Super Single, Smooth, 31" L x 19" W



FENDERS

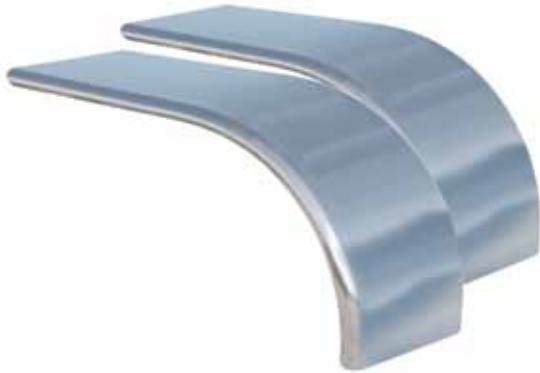

FEATURES & BENEFITS

- " Durable 2" rolled edge
- " Stainless (paddle style) steel mounting arms
- " 14- & 16-gauge stainless steel
- " Low, extended profile provides custom appearance

DROP (LOW RIDER) FENDERS

TRP® Drop Fenders measure 24" wide and are available in stainless steel quarter fenders, half tandem and full tandem. TRP® provides specific brackets to securely mount these durable fenders.

Kits cover all available styles and mount one pair of fenders.

TRP®	Description	UM
FF00431	Drop fender kit, (low rider) full tandem, 14 ga. 44' 54" 44"	PR
FF00441	Drop fender, (low rider) full tandem, 14 ga. 44' 54" 44"	EA
HF00542	Drop fender kit, (low rider) half tandem, SS 16 ga. 24.5" tire	PR
HF00522	Drop fender, (low rider), half tandem, SS 16 ga. 24.5" tire	EA
HF00523	Drop fender kit, (low rider), half tandem, SS 16 ga. 22.5"	PR
HF00524	Drop fender, (low rider), half tandem, SS 16 ga. 22.5"	EA
SA00151	Drop fender kit, (low rider), single axle, SS 16 ga. 24.5" tire	PR
SA00161	Drop fender, (low rider), single axle, SS 16 ga. 24.5" tire	EA
SA00171	Drop fender kit, (low rider), single axle, SS 16 ga. 22.5"	EA
SA00181	Drop fender, (low rider), single axle, SS 16 ga. 22.5"	PR
QT00271	Drop fender kit, (low rider) SS 14 ga 34" quarter	PR



Scan the code for more information.
Get the free mobile app at <http://gettag.mobi>

HALF & FULL FENDERS

Quarter Fenders
See Page 7-26



HALF DROP FENDERS (TANDEM) - DIAMOND PLATE (PAIR)

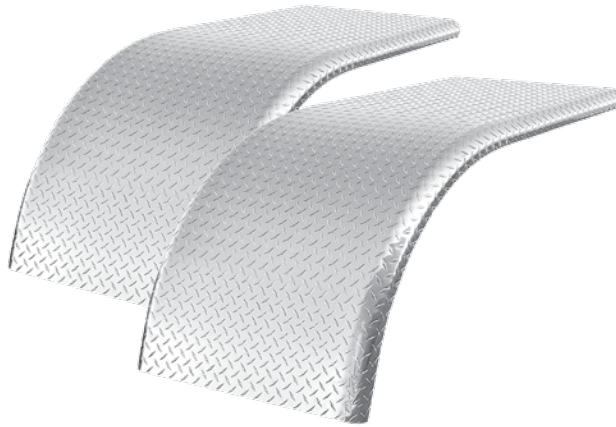

Table 7-13: Fenders - Half Tandem Fenders (Tandem) - Diamond Plate (Pair)

Part No.	Description
HF00112	66" Half Fender, 39" Front Drop, 27" Flat, 0.100" Diamond Plate Aluminum, Pair

HALF DROP FENDERS (TANDEM) - DIAMOND PLATE (SINGLE)

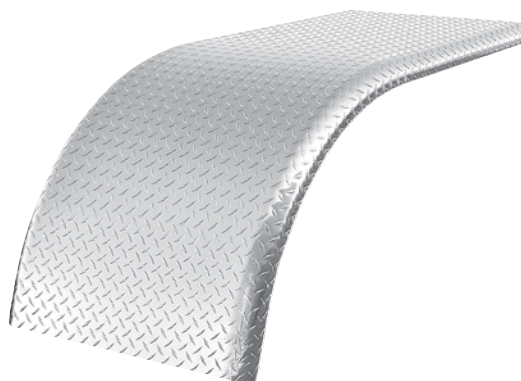

Table 7-14: Fenders - Half Tandem Fenders (Tandem) - Diamond Plate (Single)

Part No.	Description
HF00122	66" Half Fender, 39" Front Drop, 27" Flat, 0.100" Diamond Plate Aluminum, Single

HALF DROP FENDERS (TANDEM) - HEAVY DUTY, DIAMOND PLATE (SINGLE)

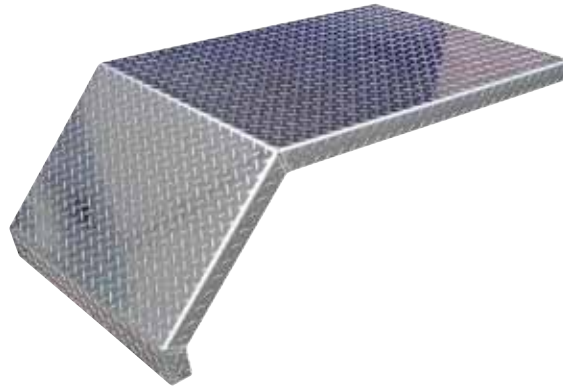

Table 7-15: Fenders - Half Drop Fenders (Tandem) - Heavy Duty Diamond Plate (Single)

Part No.	Description
HF00382	56" Half Fender, 16-3/4" Front Drop, 46" Flat, 26" Wide, Heavy Duty 3/16" Alum. Diamond Plate, Single

HALF DROP FENDERS (TANDEM) - SMOOTH (PAIR)



Table 7-16: Fenders - Half Tandem Fenders (Tandem) - Smooth Stainless Steel (Pair)

Part No.	Description
HF00141	60" Half Fender, 35" Front Drop, 25" Flat, Smooth, 16-Gauge Stainless Steel, Pair
HF00161	66" Half Fender, 35" Front Drop, 31" Flat, Smooth, 16-Gauge Stainless Steel, Pair
HF00301	60" Half Fender, 41" Front Drop, 25" Flat, Smooth, 16-Gauge Stainless Steel, Pair
HF00311	72" Half Fender, 41" Front Drop, 31" Flat, Smooth, 16-Gauge Stainless Steel, Pair
HF00331	86" Half Fender, 41" Front Drop, 45" Flat, Smooth, 16- Gauge Stainless Steel, Pair

HALF DROP FENDERS (TANDEM) - SMOOTH (SINGLE)



Table 7-17: Fenders - Half Tandem Fenders (Tandem) - Smooth Stainless Steel (Single)

Part No.	Description
HF00151	60" Half Fender, 35" Front Drop, 25" Flat, Smooth, 16-Gauge Stainless Steel, Single
HF00171	66" Half Fender, 35" Front Drop, 31" Flat, Smooth, 16-Gauge Stainless Steel, Single
HF00321	72" Half Fender, 41" Front Drop, 31" Flat, Smooth, 16-Gauge Stainless Steel, Single

HALF DROP FENDERS (TANDEM) - 3-RIBBED (PAIR)



Table 7-18: Fenders - Half Tandem Fenders - 3 Ribbed Stainless Steel (Pair)

Part No.	Description
HF00181	60" Half Fender, 35" Front Drop, 25" Flat, 3-Ribbed, 18-Gauge Stainless Steel, Pair
HF00201	66" Half Fender, 35" Front Drop, 31" Flat, 3-Ribbed, 18-Gauge Stainless Steel, Pair
HF00282	60" Half Fender, 35" Front Drop, 25" Flat, 3-Ribbed, 18-Gauge Aluminum, Pair
HF00292	66" Half Fender, 35" Front Drop, 31" Flat, 3-Ribbed, 18-Gauge Aluminum, Pair
HF00341	66" Half Fender, 35" Front Drop, 31" Flat, 3-Ribbed, 18-Gauge Stainless Steel, Pair

HALF DROP FENDERS (TANDEM) - 3-RIBBED (SINGLE)



Table 7-19: Fenders - Half Tandem Fenders - 3 Ribbed Stainless Steel (Single)

Part No.	Description
HF00191	60" Half Fender, 35" Front Drop, 25" Flat, 3-Ribbed, 18-Gauge Stainless Steel, Single
HF00211	66" Half Fender, 35" Front Drop, 31" Flat, 3-Ribbed, 18-Gauge Stainless Steel, Single

HALF DROP FENDERS (TANDEM) - 4-RIBBED (PAIR)



Table 7-20: Fenders - Half Tandem Fenders - 4 Ribbed Stainless Steel (Pair)

Part No.	Description
HF00221	60" Half Fender, 35" Front Drop, 25" Flat, 4-Ribbed, 18-Gauge Stainless Steel, Pair
HF00241	66" Half Fender, 35" Front Drop, 31" Flat, 4-Ribbed, 18-Gauge Stainless Steel, Pair
HF00261	66" Half Fender, 39" Front Drop, 27" Flat, 4-Ribbed, 18-Gauge Stainless Steel, Pair

HALF DROP FENDERS (TANDEM) - 4-RIBBED (SINGLE)



Table 7-21: Fenders - Half Tandem Fenders - 4 Ribbed Stainless Steel (Single)

Part No.	Description
HF00231	60" Half Fender, 35" Front Drop, 25" Flat, 4-Ribbed, 18-Gauge Stainless Steel, Single
HF00251	66" Half Fender, 35" Front Drop, 31" Flat, 4-Ribbed, 18-Gauge Stainless Steel, Single
HF00271	66" Half Fender, 39" Front Drop, 27" Flat, 4-Ribbed, 18-Gauge Stainless Steel, Single

FULL DROP FENDERS (TANDEM) - DIAMOND PLATE (PAIR)

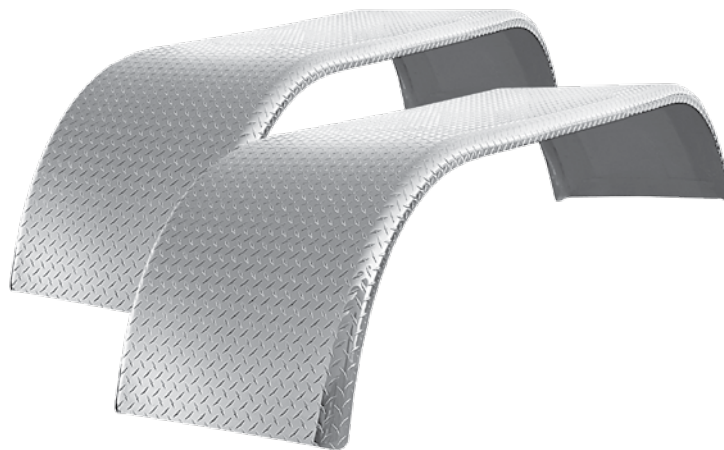

Table 7-22: Fenders - Full Drop Tandem Fenders - Diamond Plate (Pair)

Part No.	Description
FF00132	120" Full Fender, 35" Front Drop, 54" Flat, 31" Rear Drop, 0.100 Diamond Plate Aluminum, Pair

FULL DROP FENDERS (TANDEM) - DIAMOND PLATE (SINGLE)

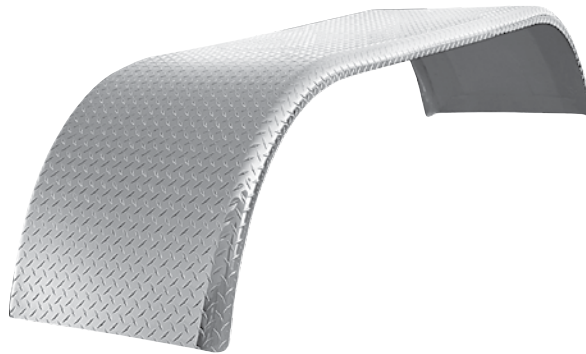

Table 7-23: Fenders - Full Drop Tandem Fenders - Diamond Plate (Single)

Part No.	Description
FF00142	120" Full Fender, 35" Front Drop, 54" Flat, 31" Rear Drop, 0.100 Diamond Plate Aluminum, Single

FULL DROP FENDERS (TANDEM) - SMOOTH (PAIR)



Table 7-24: Fenders - Full Drop Tandem Fenders - Smooth (Pair)

Part No.	Description
FF00181	120" Full Fender, 35" Front Drop, 54" Flat, 31" Rear Drop, Smooth, 16-Gauge Stainless Steel, Pair
FF00261	125" Full Fender, 35" Front Drop, 60" Flat, 25" Rear Drop, Smooth, 16-Gauge Stainless Steel, Pair
FF00342	102" Full Fender, 35" Front Drop, 54" Flat, 35" Rear Drop, Smooth, 16-Gauge Stainless Steel, Pair

FULL DROP FENDERS (TANDEM) - SMOOTH (SINGLE)



Table 7-25: Fenders - Full Drop Tandem Fenders - Smooth (Single)

Part No.	Description
FF00191	120" Full Fender, 35" Front Drop, 54" Flat, 31" Rear Drop, Smooth, 16-Gauge Stainless Steel, Single
FF00271	125" Full Fender, 35" Front Drop, 60" Flat, 25" Rear Drop, Smooth, 16-Gauge Stainless Steel, Single
FF00343	102" Full Fender, 35" Front Drop, 54" Flat, 35" Rear Drop, Smooth, 16-Gauge Stainless Steel, Single

FULL DROP FENDERS (TANDEM) - 3-RIBBED (PAIR)



Table 7-26: Fenders - Full Drop Tandem Fenders - 3 Ribbed (Pair)

Part No.	Description
FF00201	120" Full Fender, 35" Front Drop, 54" Flat, 31" Rear Drop, 3-Ribbed, 16-Gauge Stainless Steel, Pair
FF00242	120" Full Fender, 35" Front Drop, 54" Flat, 31" Rear Drop, 3-Ribbed, 16-Gauge Aluminum, Pair
FF00281	125" Full Fender, 39" Front Drop, 54" Flat, 32" Rear Drop, 3-Ribbed, 16-Gauge Stainless Steel, Pair

FULL DROP FENDERS (TANDEM) - 3-RIBBED (SINGLE)



Table 7-27: Fenders - Full Drop Tandem Fenders - 3 Ribbed (Single)

Part No.	Description
FF00211	120" Full Fender, 35" Front Drop, 54" Flat, 31" Rear Drop, 3-Ribbed, 16-Gauge Stainless Steel, Single
FF00252	120" Full Fender, 35" Front Drop, 54" Flat, 31" Rear Drop, 3-Ribbed, 16-Gauge Aluminum, Single

FULL DROP FENDERS (TANDEM) - 4-RIBBED (PAIR)



Table 7-28: Fenders - Full Drop Tandem Fenders - 4 Ribbed (Pair)

Part No.	Description
FF00291	125" Full Fender, 39" Front Drop, 54" Flat, 32" Rear Drop, 4-Ribbed, 18-Gauge Stainless Steel, Pair

SINGLE AXLE FENDERS

LIFT AXLE FENDERS - SMOOTH (PAIR)



Table 7-29: Fenders - Lift Axle Fenders

Part No.	Description
LF00011	55" Lift Axle Fender, 36" Diameter, 3-Ribbed, 16-Gauge Stainless Steel, Pair, 52 lbs.
LF00021	55" Lift Axle Fender, 36" Diameter, Smooth, 16-Gauge Stainless Steel, Pair, 52 lbs.

SINGLE AXLE FENDERS - DIAMOND PLATE (PAIR)



Table 7-30: Fenders - Single Axle Fenders - Diamond Plate (Pair)

Part No.	Description
SA00062	80" Single Axle Fender, 0.100" Diamond Plate Aluminum, Pair, 38 lbs.

SINGLE AXLE FENDERS - DIAMOND PLATE (SINGLE)



Table 7-31: Fenders - Single Axle Fenders - Diamond Plate (Single)

Part No.	Description
SA00072	80" Single Axle Fender, 0.100" Diamond Plate Aluminum, Single, 19 lbs.

SINGLE AXLE FENDERS - SMOOTH (PAIR)



Table 7-32: Fenders - Single Axle Fenders - Smooth (Pair)

Part No.	Description
SA00091	80" Single Axle Fender, Smooth, 16-Gauge Stainless Steel, Pair, 76 lbs.
SA00141	80" Single Axle Fender, Smooth, 14-Gauge Stainless Steel, Pair

SINGLE AXLE FENDERS - SMOOTH (SINGLE)



Table 7-33: Fenders - Single Axle Fenders - Smooth (Single)

Part No.	Description
SA00101	80" Single Axle Fender, Smooth, 16-Gauge Stainless Steel, Single, 38 lbs.
SA00151	80" Single Axle Fender, Smooth, 14-Gauge Stainless Steel, Single

SINGLE AXLE FENDERS - 3-RIBBED (PAIR)



Table 7-34: Fenders - Single Axle Fenders - 3-Ribbed (Pair)

Part No.	Description
SA00111	80" Single Axle Fender, 3-Ribbed, 16-Gauge Stainless Steel, Pair, 74 lbs.
SA00132	80" Single Axle Fender, 3-Ribbed, Aluminum, Pair, 39 lbs.

SINGLE AXLE FENDERS - 3-RIBBED (SINGLE)



Table 7-35: Fenders - Single Axle Fenders - 3-Ribbed (Single)

Part No.	Description
SA00121	80" Single Axle Fender, 3-Ribbed, 16-Gauge Stainless Steel, Single, 37 lbs.



FENDERS



FEATURES & BENEFITS

- » 18-gauge formed metal provides greater strength
- » 25" fender shield width enhances spray suppression and redirection

QUARTER FENDERS

TRP® Quarter Fenders have a stainless surface that provides long-term corrosion resistance to pitting, cracking and facing. Manufactured with a signature full brace design, TRP® Quarter Fenders offer superior durability.

CROSS REFERENCE

TRP®	Merritt	Fleet Engineers	LifeTime	Koneta	James King	Betts
QT00213	5060-2MTQ	031-00924	PS100B2	20300	1900KIT	S100B2
QT00101			SS100B2			SS100B2

Scan the code for more information.
Get the free mobile app at <http://gettag.mobi>



QUARTER FENDERS

FULL BRACE (POST MOUNT)

- Signature full brace design
- Durable 18 gauge



Table 7-36: Fenders - Quarter Fenders (Post Mount) - Full Brace

Part No.	Description
QT00012	Quarter Fender, Full Brace, Aluminum, Pair, 25" Wide x 22" Long
QT00022	Quarter Fender, Full Brace, Aluminum, Left, 25" Wide x 22" Long
QT00032	Quarter Fender, Full Brace, Aluminum, Right, 25" Wide x 22" Long
QT00101	Quarter Fender, Full Brace, Stainless Steel, Pair, 25" Wide x 22" Long
QT00111	Quarter Fender, Full Brace, Stainless Steel, Left, 25" Wide x 22" Long
QT00121	Quarter Fender, Full Brace, Stainless Steel, Right, 25" Wide x 22" Long
QT00205	Quarter Fender, Full Brace, Painted Carbon Steel, Pair

HALF BRACE (POST MOUNT)

- Durable 18 gauge



Table 7-37: Fenders - Quarter Fenders (Post Mount) - Half Brace

Part No.	Description
QT00042	Quarter Fender, Half Brace Low Mount, Aluminum, Pair, 25" Wide x 22" Long
QT00052	Quarter Fender, Half Brace Low Mount, Aluminum, Left, 25" Wide x 22" Long
QT00062	Quarter Fender, Half Brace Low Mount, Aluminum, Right, 25" Wide x 22" Long
QT00131	Quarter Fender, Half Brace, Stainless Steel, Pair, 25" Wide x 22" Long
QT00141	Quarter Fender, Half Brace, Stainless Steel, Left, 25" Wide x 22" Long
QT00151	Quarter Fender, Half Brace, Stainless Steel, Right, 25" Wide x 22" Long
QT00171	Quarter Fender, Half Brace Low Mount, Stainless Steel, Pair, 25" Wide x 22" Long
QT00181	Quarter Fender, Half Brace Low Mount, Stainless Steel, Left, 25" Wide x 22" Long
QT00191	Quarter Fender, Half Brace Low Mount, Stainless Steel, Right, 25" Wide x 22" Long

BRACELESS (POST MOUNT)

- Contemporary braceless design
- Durable 18 gauge



Mud Flap Hangers
See Page 7-40

Table 7-38: Fenders - Quarter Fenders (Post Mount) - Braceless

Part No.	Description
QT00071	Quarter Fender, Braceless, Stainless Steel, Pair, 25" Wide x 22" Long
QT00081	Quarter Fender, Braceless, Stainless Steel, Left, 25" Wide x 22" Long
QT00091	Quarter Fender, Braceless, Stainless Steel, Right, 25" Wide x 22" Long

EXTREME WEATHER POLYLINE (POST MOUNT)

- Contemporary braceless design
- High density polyethylene construction



Table 7-39: Fenders - Quarter Fenders (Post Mount) - Extreme Weather Polyline

Part No.	Description
QT00213	Quarter Fender, Braceless, Extreme Weather Polyline, Black Polyethylene, Pair, 25" Wide x 24" Long
QT00233	Quarter Fender, Braceless, Extreme Weather Polyline, Black Polyethylene, Right, 25" Wide x 24" Long
QT00223	Quarter Fender, Extreme Weather Polyline, Black Polyethylene, Left, 25" Wide x 24" Long

QUARTER FENDERS (POST MOUNT) - SINGLE ARM (PADDLE STYLE)



Table 7-40: Fenders - Quarter Fenders (Post Mount) - Single Arm (Paddle Style)

Part No.	Description
QT00241	Quarter Fender, Single Arm (Paddle Style), Stainless Steel, Pair, 24" Wide x 27" Long
QT00251	Quarter Fender, Single Arm (Paddle Style), Stainless Steel, Pair, 24" Wide x 24" Long

FENDER MOUNTING KITS

FULL TANDEM POLYETHYLENE MOUNTING KIT



Table 7-41: Fender Mounting Kits - Fenders - Full Tandem Mounting Kit (Poly)

Part No.	Description
FB00055	Full Tandem Polyethylene Mounting Kit

FULL TANDEM SIDE MOUNT KIT



Table 7-42: Fender Mounting Kits - Full Tandem Side Mounting Kit (Stainless Steel)

Part No.	Description
FB00281	Full Tandem Side Mount Kit, Stainless Steel, without Center Bracket

HALF TANDEM POLYETHYLENE MOUNTING KIT



Table 7-43: Fender Mounting Kits - Half Tandem Mounting Kits

Part No.	Description
FB00025	Half Tandem Polyethylene Mounting Kit

HALF TANDEM SIDE MOUNT KIT WITH 29" SIDE MOUNT PIPE



Table 7-44: Fender Mounting Kits - Half Tandem Mounting Kits

Part No.	Description
FB00341	Half Tandem Side Mount Kit, Stainless Steel, 29" Side Mount Pipe, without Center or Rear Brackets

HALF FENDER MOUNTING KIT WITH BRACES

Table 7-45: Fender Mounting Kits - Half Fender Mounting Kit with Braces

Part No.	Description
FB00277	Half Fender Mounting Kit with Braces, Stainless Steel

HALF TANDEM MOUNTING KITS FOR SUPER SINGLE FENDERS



Table 7-46: Fender Mounting Kits - Half Tandem Mounting Kits for Super Single Fenders

Part No.	Description
FB00681	Half Tandem Fender Mounting Kit, Super Single, Stainless Steel

HALF TANDEM SIDE MOUNT KIT WITHOUT CENTER OR REAR BRACKETS



Table 7-47: Fender Mounting Kits - Half Tandem Side Mount Kit without Center or Rear Brackets

Part No.	Description
FB00311	Half Tandem Side Mount Kit, Stainless Steel, without Center or Rear Brackets

HARDWARE BOXES FOR MOUNTING KITS



Image of Hardware
for Reference Only

Table 7-48: Fender Mounting Kits - Hardware Boxes for Mounting Kits

Part No.	Description
FH00021	Hardware Box for Use with FB00311 Mounting Kit, Stainless Steel
FH00041	Hardware Box for use with FB00331 Mounting Kit, Stainless Steel
FH00051	Hardware Box for use with FB00267, or FB00277 Mounting Kits, Stainless Steel
FH00061	Hardware Box for use with FB00341 Mounting Kits, Stainless Steel
FH00081	Hardware Box for use with FB00301 Mounting Kits, Stainless Steel

QUARTER FENDER MOUNTING KIT



Table 7-49: Fender Mounting Kits - Quarter Fender Mounting Kit

Part No.	Description
QT00161	Quarter Fender Mounting Kit, Pair

SINGLE AXLE SIDE MOUNT KIT



Table 7-50: Fender Mounting Kits - Side Mount Kit

Part No.	Description
FB00331	Single Axle, Side Mount Kit, Stainless Steel

SINGLE AXLE MOUNTING KIT - POLYETHYLENE



Table 7-51: Fender Mounting Kits - Single Axle Mounting Kit

Part No.	Description
FH00015	Single Axle Polyethylene Mounting Kit

SINGLE AXLE MOUNTING KIT FOR SUPER SINGLE FENDERS

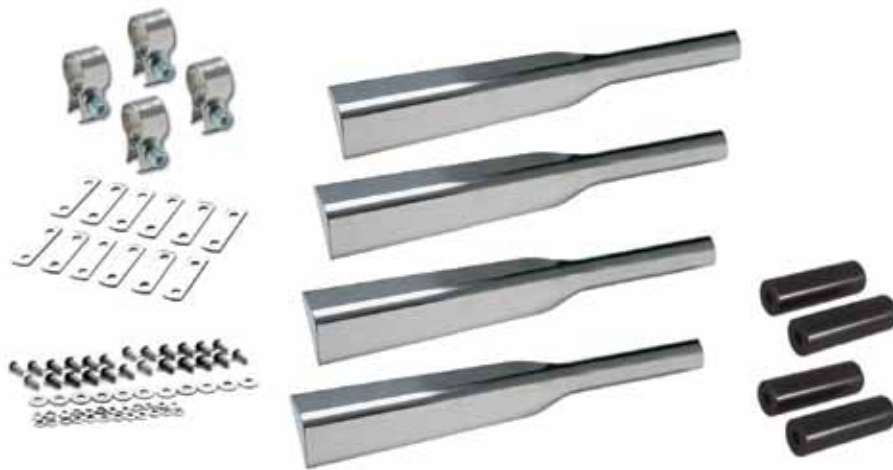

Table 7-52: Fender Mounting Kits - Single Axle Mounting Kit for Super Single Fenders

FB00691	Full Round Single Axle Mounting Kit, Super Single, Stainless Steel
---------	--

FENDER MOUNTING HARDWARE & ACCESSORIES

ARM CLAMP



Table 7-53: Fender Hardware & Accessories - Arm Clamp

Part No.	Description
FM00031	Arm Clamp, N200-SS7, Critical Mounting Part

BRACKET KIT



Table 7-54: Fender Hardware & Accessories - Bracket Kit

Part No.	Description
FB00011	Bracket Kit, Paddle Style, Stainless Steel, Single

CENTER OR REAR MOUNTING BRACKETS - 12-3/4"



Table 7-55: Fender Hardware & Accessories - Center or Rear Mounting Brackets - 12-3/4"

Part No.	Description
FB00085	Standard Center or Rear Mounting Bracket, 12-3/4" Height, 4" x 6" Plate, 4-1/4" Bolt Hole Center (LH/RH)

CENTER OR REAR MOUNTING BRACKETS - 6-1/2" TO 11-5/8"

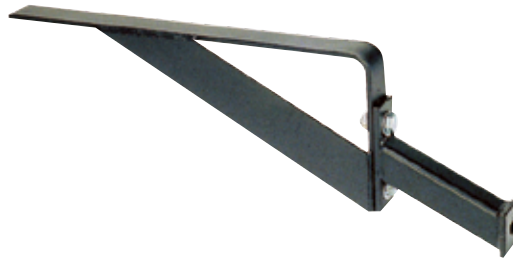

Table 7-56: Fender Hardware & Accessories - Center or Rear Mounting Brackets - 6-1/2" to 11-5/8"

Part No.	Description
FB00145	Standard Center or Rear Mounting Bracket, 6-1/2" to 11-5/8" Height, No plate, Single hole, Adjustable (LH)
FB00155	Standard Center or Rear Mounting Bracket, 6-1/2" to 11-5/8" Height, No plate, Single hole, Adjustable (RH)

CENTER OR REAR MOUNTING BRACKETS - 12-1/2"



Table 7-57: Fender Hardware & Accessories - Center or Rear Mounting Brackets - 12-1/2"

Part No.	Description
FB00165	Standard Center or Rear Mounting Bracket, 12-1/2" Height, No plate, Slotted (LH)
FB00175	Standard Center or Rear Mounting Bracket, 12-1/2" Height, No plate, Slotted (RH)

CENTER/REAR MOUNTING BRACKETS FOR SUPER SINGLE FENDERS

Table 7-58: Fender Hardware & Accessories - Center/Rear Mounting Brackets for Super Single Fenders

FB00735	Center Bracket Super Single, Carbon Steel Painted, (1 PC) LH, 8-1/2" X 11-5/8"
FB00745	Center Bracket Super Single, Carbon Steel Painted, (1 PC) RH, 8-1/2" X 11-5/8"

END CAPS



Table 7-59: Fender Hardware & Accessories - End Caps

Part No.	Description
FM00013	End Caps, 2" Tube

MOUNTING ARMS



Table 7-60: Fender Hardware & Accessories - Mounting Arms

Part No.	Description
FB00031	Mounting Arms, 14 Gauge, Critical Mounting Part

MOUNTING ARM/BRACKET - SIDE MOUNT FOR SUPER SINGLE FENDERS

Table 7-61: Fender Hardware & Accessories - Mounting Arm/Bracket for Super Single Fenders

Part No.	Description
FB00701	Mounting Arm Super Single, Stainless Steel

POST FRONT MOUNT



Table 7-62: Fender Hardware & Accessories - Post Front Mount

Part No.	Description
FB00065	Post Front Mount, 7-1/2", 3/4"-16 NF, Critical Mounting Part

POST FRONT MOUNTING PIPE



Table 7-63: Fender Hardware & Accessories - Post Front Mounting Pipe

Part No.	Description
FB00077	Post Front Side Mounting Pipe, Stainless Steel, Single

CRITICAL FENDER MOUNTING PART - SIDE MOUNT BRACKET



Table 7-64: Fender Hardware & Accessories - Critical Fender Mounting Part - Side Mount Bracket

Part No.	Description
FB00191	Side Mount Bracket, 29" Pipe, Stainless Steel

CRITICAL MOUNTING PART - UNIVERSAL RIBBED INSULATOR



Table 7-65: Fender Hardware & Accessories - Critical Mounting Part - Universal Ribbed Insulator

Part No.	Description
FM00046	Universal Ribbed Insulator, Critical Mounting Part

TOP FLAP FOR QUARTER FENDER



Table 7-66: Fender Hardware & Accessories - Top Flap

Part No.	Description
FM00023	Top Flap, Black Polyethylene

MUD FLAP HANGERS

MUDFLAP HANGERS - 27" SHORT FLEX



Table 7-67: Fender Hardware & Accessories - Mudflap Hangers

Part No.	Description
FB00491	Mudflap Hanger, 27" Stainless Steel, 45° Short Flex (LH)
FB00511	Mudflap Hanger, 27" Stainless Steel, 45° Short Flex (RH)

MUDFLAP HANGERS - 30" SHORT FLEX



Table 7-68: Fender Hardware & Accessories - Mudflap Hangers

Part No.	Description
FB00525	Mudflap Hanger, 30" Painted Steel, 45° Short Flex, Pair
FB00535	Mudflap Hanger, 30" Painted Steel, 45° Short Flex (RH)
FB00545	Mudflap Hanger, 30" Painted Steel, 45° Short Flex (RH)
FB00551	Mudflap Hanger, 30" Stainless Steel, 45° Short Flex, Pair
FB00561	Mudflap Hanger, 30" Stainless Steel, 45° Short Flex (LH)
FB00571	Mudflap Hanger, 30" Stainless Steel, 45° Short Flex (RH)

MUDFLAP HANGERS - SHORT FLEX WITH CONSPICUITY TAPE



Table 7-69: Fender Hardware & Accessories - Mudflap Hangers

Part No.	Description
FB00471	Mudflap Hanger, 27" Stainless Steel, 45° Short Flex, with Conspicuity Tape (LH)
FB00481	Mudflap Hanger, 27" Stainless Steel, 45° Short Flex, with Conspicuity Tape (RH)

MUDFLAP HANGERS (PREMIUM FLEX)

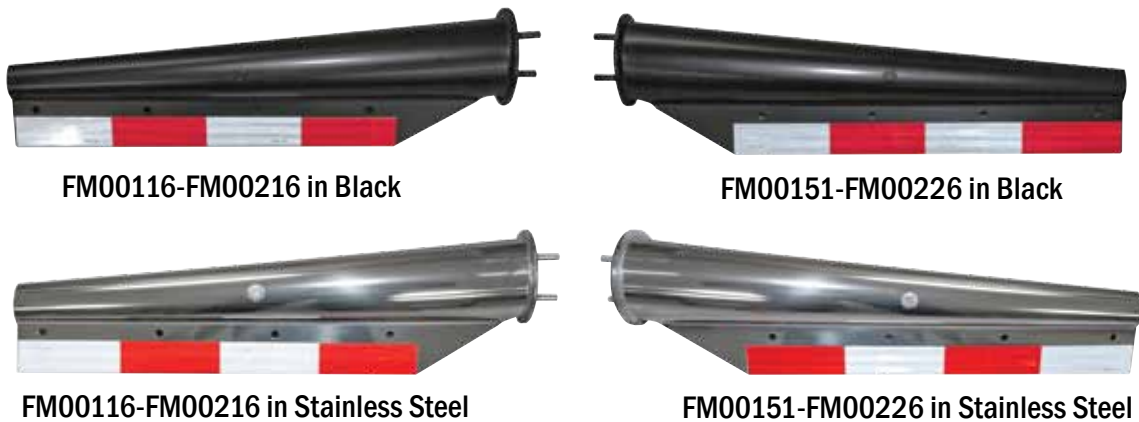

Table 7-70: Fender Hardware & Accessories - Mudflap Hangers (Premium Flex)

Part No.	Description
FM00116	Mudflap Hanger PF, 30" Painted Fender, 2-1/2" Mounting Hole Spacing, with Conspicuity Tape (LH)
FM00136	Mudflap Hanger PF, 30" Painted Fender, 2-1/2" Mounting Hole Spacing, with Conspicuity Tape (RH)
FM00151	Mudflap Hanger PF, 30" SS, Fender, 2-1/2" Mounting Hole Spacing, with Conspicuity Tape (LH)
FM00171	Mudflap Hanger PF, 30" SS, Fender, 2-1/2" Mounting Hole Spacing, with Conspicuity Tape (RH)
FM00216	Mudflap Hanger PF, 30" Painted Fender, 2-1/4" Mounting Hole Spacing, with Conspicuity Tape (LH)
FM00226	Mudflap Hanger PF, 30" Painted Fender, 2-1/4" Mounting Hole Spacing, with Conspicuity Tape (RH)
FM00231	Mudflap Hanger PF, 30" SS, Fender, 2-1/4" Mounting Hole Spacing, with Conspicuity Tape (LH)
FM00241	Mudflap Hanger PF, 30" SS, Fender, 2-1/4" Mounting Hole Spacing, with Conspicuity Tape (RH)



AIR SPRINGS

FEATURES & BENEFITS

- " Made with a unique fabric material that has a higher burst rate for longer life
- " Chemically formulated vulcanized material withstands ozone effects
- " Optimized wall thickness for better fatigue life
- " 100% leak tested

RELATED PARTS

For maximum suspension performance and life, it is recommended that at time of installations all bushings and height control valves are inspected and replaced as needed.



AIR SPRINGS

Made with a unique fabric material, TRP® Air Springs have a 50 PSI higher burst rating than the competition. The vulcanized material has been chemically formulated to withstand ozone effects to resist cracking and splitting. The wall thickness is optimized to provide a better fatigue life, while providing a lightweight air spring. Available for all truck and trailer applications, TRP® Air Springs are 100% leak tested and provide a cost effective solution toward improved driving safety and comfort level of all air-suspended commercial vehicles.

CROSS REFERENCE

Air Spring	Description	Firestone	Good Year
AS9780A	Freightliner Aluminum Base 681-320-0017	W01-358-9780 Aluminum	1R12-303 Aluminum
AS9780P	Freightliner, Standard Base	W01-358-9780 Plastic	1R12-303 Plastic
AS92130	Navistar 1660581C1, 501559C1, 501559C2	W01-358-9213	W01-358-6897
AS74100	Freightliner 16-11378-000	W01-358-7410	2B12-406
AS92190	Volvo 35003-3201,3,4	W01-358-9219	1R12-182
AS94660	Mack 364SQ28, Hendrickson 49674	W01-358-9466	1R12-365
AS93710	Navistar 1670043C1	W01-358-9371	1R12-401
AS92870	Hendrickson 50405	W01-358-9287	1R12-424
AS92650	Hendrickson Primaax (Old Version - Not EX)	W01-358-9265	1R12-375
AS96480	Navistar 2027911C1, C2, C3	W01-358-9648	1R12-538
AS91220	Hendrickson 12514-008, Navistar 1681748C1, Neway 905-57-020	W01-358-9122	1R14-045



Scan the code for more information.
Get the free mobile app at <http://gettag.mobi>

SUSPENSION & RIDE CONTROL



Shocks
See Page 7-136



AIR SPRINGS APPLICATION TABLE

Table 7-71: Suspension & Ride Control - Air Springs Application Table

Product	Part No.	Applications	Bellows No.
	AS2467G	Ridewell 1000001	9 10-19
	AS52980	Air Spring for Gillig LLC Low Floor Front 08 372 09 000N	6 6.5B-11

Note: See Air Spring Cross Reference immediately following the Air Spring Application Table.

CHASSIS

Product	Part No.	Applications	Bellows No.
	AS53000	Air Spring for Flxible 6 336-4	6 6.5-11
	AS53100	Air Spring for Flxible 6 336-2/ Crown Coach 6 336-2	6 6.5-11
	AS53110	Air Spring for Flxible 6 379-1	6 6.5-11
	AS53150	Air Spring for Flxible 6 379-6	6 6.5-11
	AS53160	Air Spring for New Flyer 6160104	6 6.5-11
Image Not Available	AS54060	Air Spring for Flxible 6 336-11/ GMC 715611	6 6.5-13

Note: See Air Spring Cross Reference immediately following the Air Spring Application Table.

Product	Part No.	Applications	Bellows No.
	AS54090	Air Spring for AM General 5973923, 5973877/ New Flyer 5973877, 5993113	6 6.5-13
	AS55030	Neway W&C Trucks- Pusher Or Tags, Cont. WCAL-2200-ES (Ride)	11 10.5-22
	AS55031	Watson & Chalin AS-0047G	11 10.5-22
	AS62580	Arvin Meritor 21227892 FS25	9 10-17.5
	AS67890	Hendrickson Aux. 001503	FD 330-30
	AS67990	Neway Lift Suspension: CLB (14, 15, 16, 17), 905-57-203	FD 530-35

Note: See Air Spring Cross Reference immediately following the Air Spring Application Table.

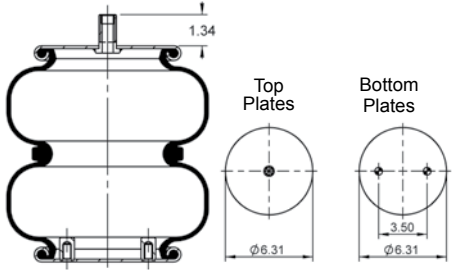
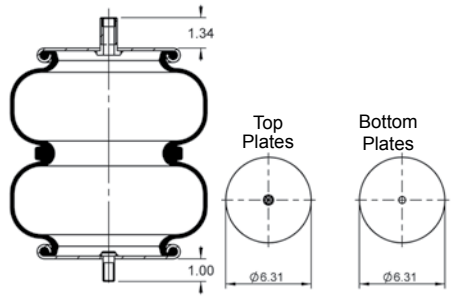
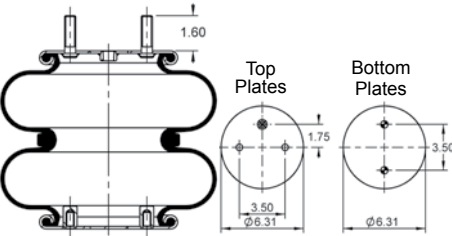
Product	Part No.	Applications	Bellows No.
	AS68830	Watson & Chalin AS-0092	FD 200-22
	AS68860	Watson & Chalin AS-0058-1F Reyco 701784-01	FD 200-22
	AS68900	Neway Lift Suspension: VS-14-4 (V-Steer-1) (Lift)	FD 200-19

Note: See Air Spring Cross Reference immediately following the Air Spring Application Table.

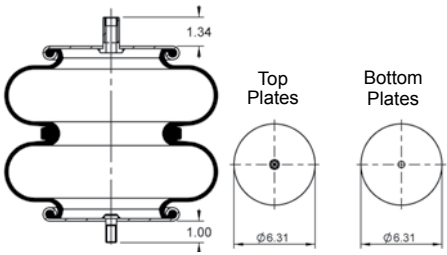
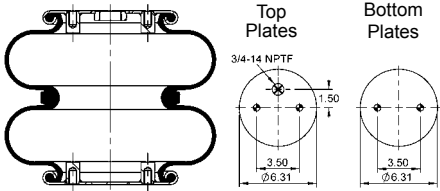
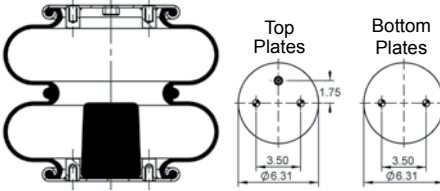
Product	Part No.	Applications	Bellows No.
	<p>AS68970</p>	<p>Watson & Chalin W&C Trucks: AL-2200, -LW, -SSR, -RO (Lift), AL-2200 ES (Lift) AL-2200-LP (Lift) SL-2200-13.5, 15 (Lift) W&C Steering Liftables: LWSTL-1100 (Lift) STL-1100 Tru-Track (Lift) STL-1800 (Lift) TL-1100 (Lift) TL-2200-23 Thru 34 (Lift) TL-2200-9 Thru 20 (Lift) TL-2200LP (Lift) TL-2200-SSR (Lift) TL-8100 (Lift) TL-9000-16B, -19, -21, -30 (Lift) TL-9000-17.5/16.5 (Lift) W&C Liftables Tru-Track (Lift): W&C Steerables: WCSL-1100-LR, SR, SSR (Lift) WCSL-1100-RO (Lift) WCSL-1700-RO (Lift) WCSL-1400-SR, SRR (Lift) WCSL-1800-SR (Lift) WCLWSI-1100 Tru Track (Lift) W&C Steerables Cont. WCLWSI-1100-LW (Lift) W&C Steerables WCLWSI-1100-SSR-LW (Lift)</p>	<p>FD 200-19</p>
	<p>AS69000</p>	<p>Air Spring for Trailer De Monterrey 73312/ Diesel Nacional A1Z-8127-19</p>	<p>FD 200-19</p>
	<p>AS69020</p>	<p>Granning, Hendrickson Hendrickson: MTL-45&50 (Lift) HLR Series ST-031 (Lift) HLR Series ST-004 (Lift) HLR Series RW14A-X (Lift)</p>	<p>FD 200-19</p>

Note: See Air Spring Cross Reference immediately following the Air Spring Application Table.

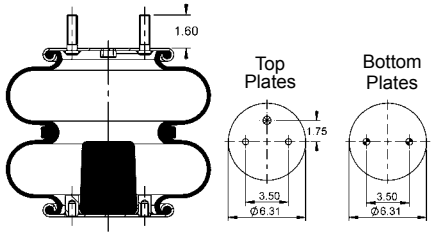
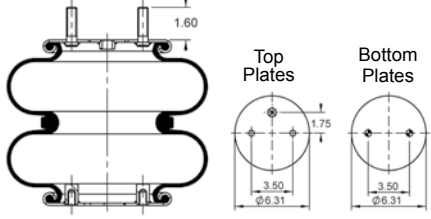
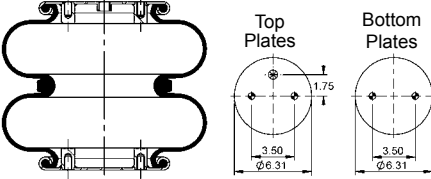
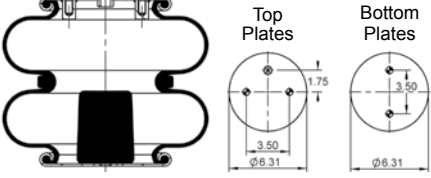
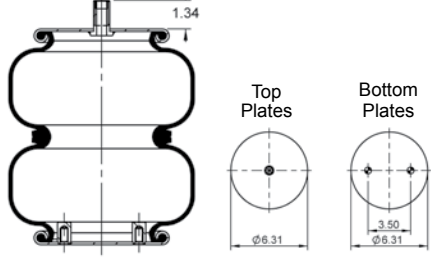
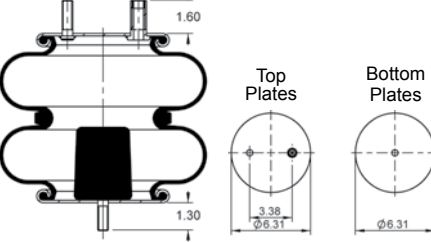
Product	Part No.	Applications	Bellows No.
	AS69050	Hendrickson: 3516 5270 Loadguard SC2071 Navistar 1685175C1 Ridewell 1003586905C Silent Drive AS-6882 Watson & Chalin AS-0020 Volvo 85101146	FD 200-19
	AS69080	Watson & Chalin AS-0034	FD 200-19
	AS69100	Granning Hendrickson Autobus Olimpico	FD 200-19
	AS69260	Load Share	FD 200-19
	AS69270	Reyco W&C Trucks- Pusher Or Tags: Cont. WCAL-2200-LW (Lift)	FD 200-25
	AS69320	Ridewell 1003586932C	FD 200-19

Note: See Air Spring Cross Reference immediately following the Air Spring Application Table.

Product	Part No.	Applications	Bellows No.
	AS69350	Hendrickson Auxiliary Hendrickson: HLM-1&2 (Lift)	FD 200-19
	AS69400	HS Industries/ Link Hyster 10305	FD 200-19
	AS69410	HS Industries/ Link Hyster 10302	FD 200-19
	AS69430	Van Raden TL-2700-HD-14-ES Neway Lift Suspension VSA-14-4 (V-Steer-2) (Lift)	FD 200-25
	AS69440	HS Industries/ Link Hyster 10307 Suspensions, Inc	FD 200-25

Note: See Air Spring Cross Reference immediately following the Air Spring Application Table.

Product	Part No.	Applications	Bellows No.
	AS69450	Ridewell 1003586945C	FD 200-25
	AS69460	Loadguard SC2126 Ridewell 1003586946C Suspensions Inc. 200180	FD 200-25
	AS69470	Hendrickson Auxiliary Hendrickson Trailer S8701 Ridewell 1003586947C	FD 200-25
	AS69480	Hendrickson Trailer S8701 Ridewell 1003586948C	FD 200-25
	AS69490	Load Air P-10972-A	FD 200-19

Note: See Air Spring Cross Reference immediately following the Air Spring Application Table.

CHASSIS

Product	Part No.	Applications	Bellows No.
	AS69600	Granning 7025	FD 200-25
	AS69620	Hendrickson Trailer S21323	FD 200-25
	AS69940	Capacity of Texas	FS 330-11
	AS70080	Neway SAF Holland 905-57-226	FS 330-11
	AS70090	Neway SAF Holland 905-57-002	FS 330-11
Image Not Available	AS70460	Link 1102-0022	n/a
Image Not Available	AS70640	Link 1102-0074 (Kenworth)	n/a
Image Not Available	AS70750	Link 1102-0048+G271	n/a
Image Not Available	AS70820	Freightliner Western Star	n/a

Note: See Air Spring Cross Reference immediately following the Air Spring Application Table.

CHASSIS

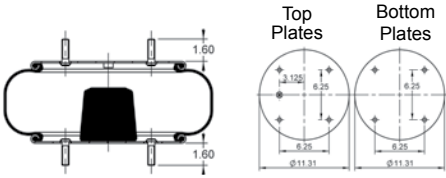
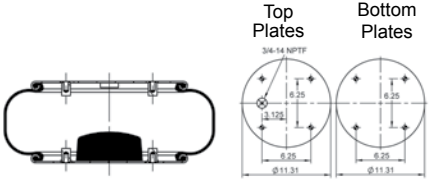
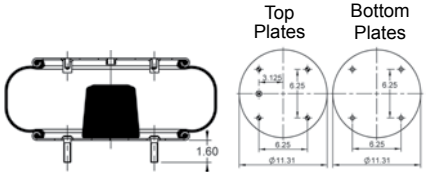
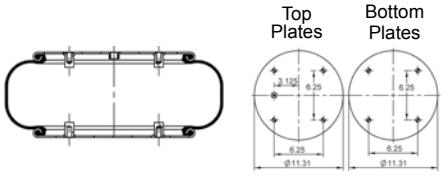
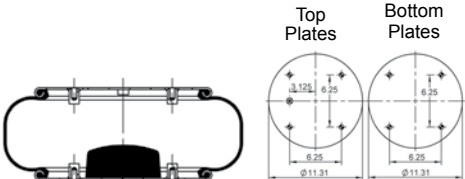
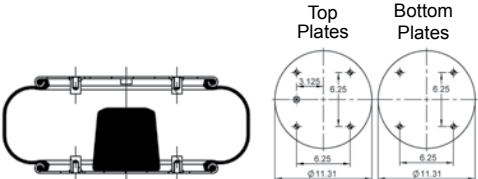
Product	Part No.	Applications	Bellows No.
	AS70880	Suspensions Inc. 200175	FS 530-14
Image Not Available	AS70920	Link 1102-0083 (Kenworth KWCSA)	n/a
	AS70940	Chalmers	FS 530-14
	AS70960	Suspensions Inc. 200792	FS 530-14
Image Not Available	AS71000	3-T's	n/a
	AS71030	Peerless 0550-00015	FS 530-14
	AS71040	n/a	FS 530-14
	AS71050	American Carrier 8003-007	FS 530-14

Note: See Air Spring Cross Reference immediately following the Air Spring Application Table.

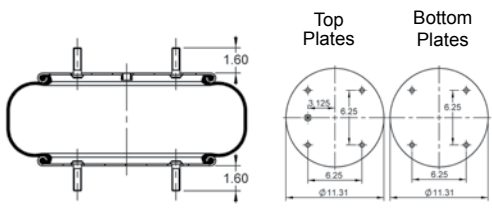
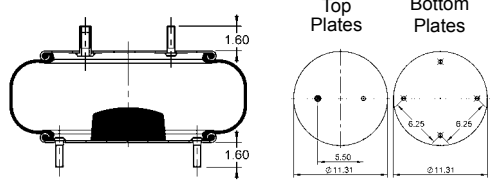
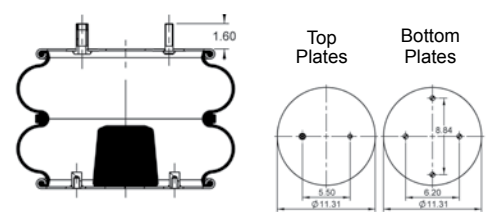
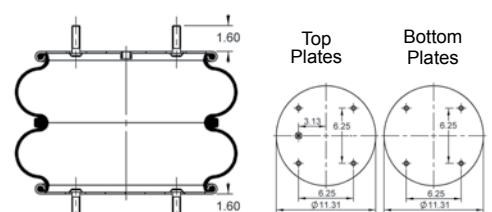
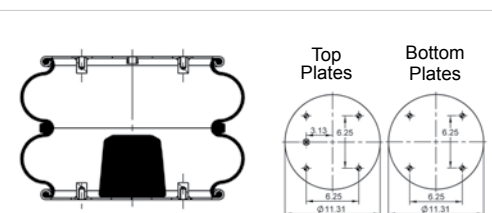
Product	Part No.	Applications	Bellows No.
	AS71120	Neway Hendrickson 13044 SAF Holland: 905-57-028 905-57-026 905-57-041 Loadguard SC2012 Navistar 554672C1 Ridewell 1003587112C	FS 530-14
	AS71170	American Carrier	FS 530-14
	AS71230	Kwik Lok/ TODCO (Jifflox) Hendrickson 13048 SAF Holland 570-07-123 Loadguard SC2080 Navistar 1685184C1	FD 530-22
	AS71350	Hendrickson Canada Neway Lift Suspension: AL75-B, 76-A, AL-77, AL-78 (Lift) ALT-500-US, ALT-550-US (Lift)	FD 530-22
	AS71360	Fargo (Trailer) Hendrickson: HLQ Series QW12A-X Hendrickson Lifts: CL	FD 530-22

Note: See Air Spring Cross Reference immediately following the Air Spring Application Table.

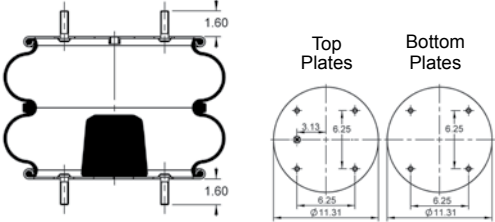
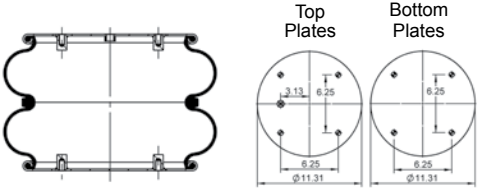
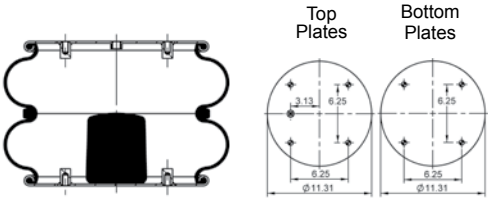
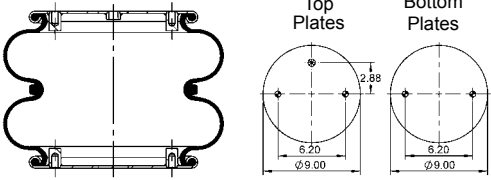
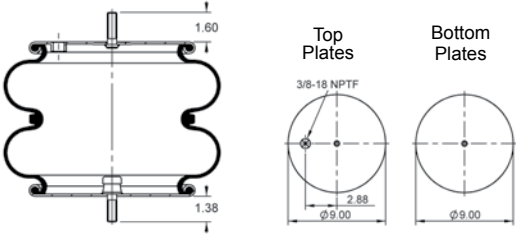
Product	Part No.	Applications	Bellows No.
	AS71400	Granning Hendrickson 3184 Watson & Chalin AS-0008 SAF Holland: 570-07-140 905-57-257 Granning 1015 Loadguard SC2015 Navistar 554799C1 Porcupine 7142	FD 530-22
	AS71450	Hendrickson 6412 SAF Holland 570-06-803 Mack 57QL239 Ridewell 1003587145C Volvo / GM-Heavy Duty 35203-0005 Loadguard SC2129	FD 530-22
	AS71460	Gallenberg Hendrickson 12046 SAF Holland: 905-57-039 905-57-024 American Carrier 8003-005 Loadguard SC2017 Navistar 554797C1 Ridewell 100358714C	FD 530-22
	AS71800	Continental SAF Holland 570-07-180 EZ Ride 8030190 Loadguard SC2075 Navistar 1685179C1 Peerless 0550-000001 Ridewell 1003587180C FD 330-22 363	FD 330-22
	AS71810	Fruehauf (Trailer) Hendrickson 13050 SAF Holland 570-07-181 Fruehauf: UAB-5620 UCC-3054-1 Loadguard SC2018 Navistar 554794C1	FD 330-22

Note: See Air Spring Cross Reference immediately following the Air Spring Application Table.

Product	Part No.	Applications	Bellows No.
	AS71830	Fruehauf (Trailer) SAF Holland 570-07-183 Fruehauf: UCA-0112 UCA-0112-B Loadguard SC2019 Navistar 554795C1	FD 330-22
Image Not Available	AS72000	Freightliner / Sterling 18-42609-000 Ford F6HT5C-063BA (old)	n/a
Image Not Available	AS73250	Hendrickson (Trailer) Autobus Avante	FD 120-20
	AS73440	Flxible: 6-336-13 6-336-5 Load Air P10-755C	FD 330-22
	AS74000	FAB TEK (West Unit) Lev. Watson / Freightliner	FD 330-22
	AS74010	GMC Watson & Chalin AS-0014 Chevrolet/GMC: 711954 2076095 Navistar 554789C1 Volvo 2076095	FD 330-22
	AS74030	Granning Hendrickson: HLQ Series QS16A-X HLR Series RT14D-X (Truck) (Lift) HLR Series RW14B-X&14C-X (Trailer) (Lift) HL-015 (Lift)	FD 330-22

Note: See Air Spring Cross Reference immediately following the Air Spring Application Table.

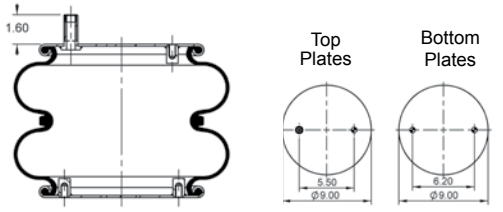
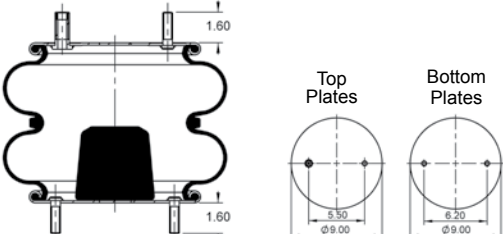
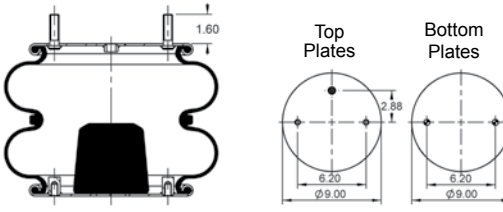
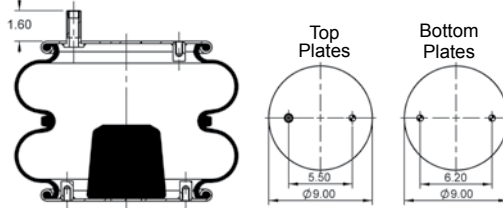
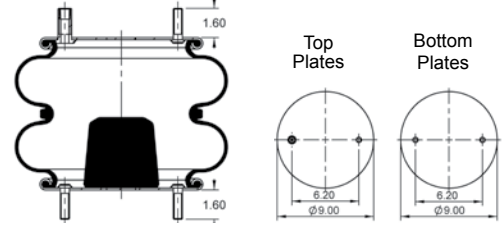
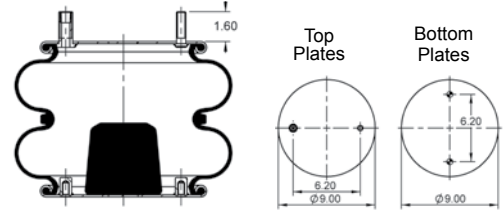
Product	Part No.	Applications	Bellows No.
	AS74040	Hendrickson Trailer S5468 Hendrickson Canada S1345	FD 330-22
	AS74050	SAF Holland 570-07-405 Hutchins 10384-01 Loadguard SC2073 Navistar 1685177C1 Suspensions Inc 200981	FD 330-22
	AS74060	RidewellSAF Holland 570-07-406 Loadguard SC2076 Navistar 1685180C1 Ridewell 1003587406C	FD 330-22
	AS74080	EZ Ride	FD 330-22
	AS74090	Fruehauf (Trailer) Watson & Chalin AS-0093 SAF Holland 570-07-409 Loadguard SC2074 Navistar 1685178C1	FD 330-22
	AS74100	Hendrickson 10170 SAF Holland 570-07-410 Freightliner 16-11378-000 Loadguard SC2023 Navistar 554792C1 Volvo 85101158	FD 330-22

Note: See Air Spring Cross Reference immediately following the Air Spring Application Table.

Product	Part No.	Applications	Bellows No.
	AS74230	Sauer Loadguard SC2101 Navistar 1681750C1	FD 330-22
	AS74240	Integrated Neway Lift Suspension: AL-41, AL-41-US (Lift) AL-45-9, 12, 14, 17 (Lift) AL-40-US (Lift) AL-42, AL-42-US (Lift) AL-50, AL-50-US (Lift) AL-70, AL-70-US (Lift) ALT-40, ALT-40-L ALT-40-US, ALT-50-US, ALT-70-US	FD 330-22
	AS74290	Kwik Lok/ TODCO (Jifflox) Hendrickson 13052 SAF Holland 570-07-429 Loadguard SC2077 Navistar 1685181C1	FD 330-22
	AS74370	Neway Trailer Air: ARL-20-D, -US Neway Powered Truck: ARL-20-D, -US	FD 330-22
	AS74430	Granning W&C Trucks- Pushers Or Tags: WCAL-1200-DB (Lift) WCAL-1600-DB (Lift)	FD 330-30
	AS74440	Hendrickson Trailer S9830	FD 330-30

Note: See Air Spring Cross Reference immediately following the Air Spring Application Table.

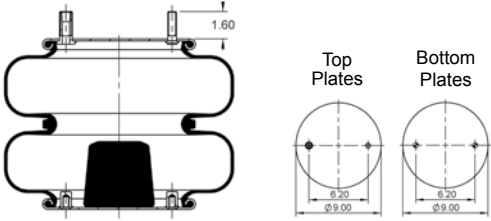
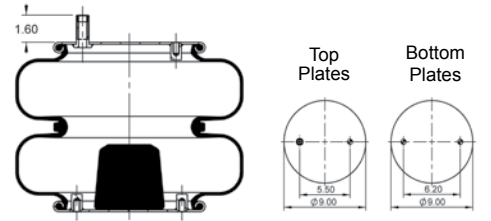
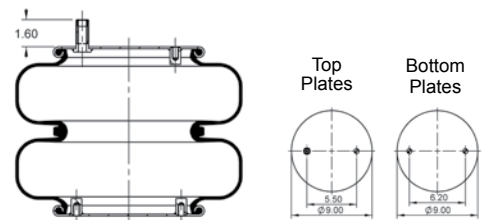
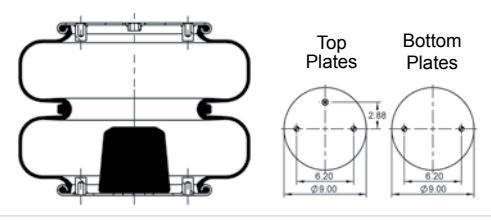
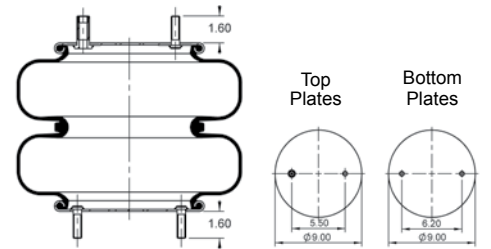
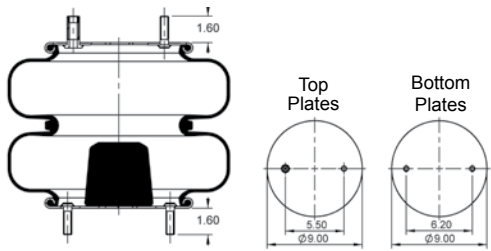
Product	Part No.	Applications	Bellows No.
	AS74460	Hendrickson (Trailer) W&C Trucks- Pushers Or Tags: WCAL-1900 (Lift)	FD 330-30
	AS74470	Hendrickson Auxiliary Hendrickson Lifts: HTCL	FD 330-30
	AS74720	Hendrickson Canada B-12514-005	FD 330-30
	AS74730	SAF Holland 570-07-473 Loadguard SC2078 Navistar 1685182C1 Ridewell 1003587473C	FD 330-30
	AS74830	Ridewell 1003587483C	FD 330-30
	AS74990	Suspensions Inc. 201602	FD 330-30

Note: See Air Spring Cross Reference immediately following the Air Spring Application Table.

Product	Part No.	Applications	Bellows No.
	AS75450	Hendrickson Auxiliary Hendrickson: HLUH (Ultra High Lift) (Lift)	FD 331-26
	AS75500	HS Industries/ Link Watson & Chalin AS-0087 Hyster 10315	FD 331-26
	AS75550	Reyco W&C Steerables: Cont. WCLWSL-1000-HLFL-TT (Lift) WCLWSL-1100-TTHL-ES (Lift)	FD 331-26
	AS75570	HS Industries/ Link Reyco 19983-01 Watson & Chalin S-0089 Hyster 10316	FD 530-35
	AS76860	Rowe Truck & Body 0035	FD 200-19

Note: See Air Spring Cross Reference immediately following the Air Spring Application Table.

Product	Part No.	Applications	Bellows No.
	AS77050	Watson & Chalin AS-006	FD 120-20
	AS77810	Ridewell 1003587781C	FD 530-35
	AS77820	Porcupine W&C Steerables: WCHL-1100 (Lift)	FD 530-35
Image Not Available	AS77840	Suspensions, Inc.	FD 530-35 528
	AS77880	Watson & Chalin AS-0088	FD 200-19
	AS77900	Hendrickson Auxiliary Hendrickson: HLQ Series QT20A-X	FD 330-30

Note: See Air Spring Cross Reference immediately following the Air Spring Application Table.

Product	Part No.	Applications	Bellows No.
	<p>AS77950</p>	<p>Hendrickson Auxiliary Hendrickson: HLN (Truck) (Lift) HLN (Trailer) (Lift) HLP (Lift) HLP (Trailer) (Lift) HLU (Lift) HLUS (Lift)</p>	<p>FD 200-19</p>
	<p>AS77960</p>	<p>Ridewell 1003587796C</p>	<p>FT 530-32</p>
	<p>AS77970</p>	<p>Hendrickson Aux. 001346</p>	<p>FT 530-32</p>
	<p>AS77980</p>	<p>Granning W&C Steering Tables Liftables: STL-1800 (Ride) W&C Steerables: WCSL-1700-RO (Ride) WCSL-1800-SR (Ride)</p>	<p>FT 530-32</p>
	<p>AS78000</p>	<p>Granning SAF Holland 570-07-800 Silent Drive AS-7800 Granning 4514 Holland Hitch 4514 Loadguard SC2030 Ridewell 1003587800C</p>	<p>FT 530-32</p>

Note: See Air Spring Cross Reference immediately following the Air Spring Application Table.

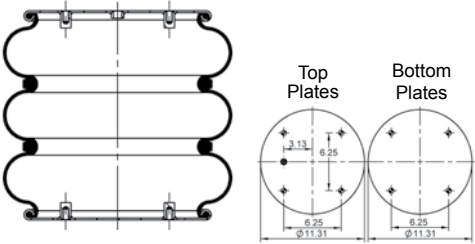
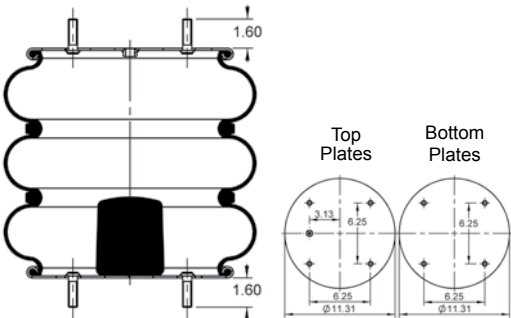
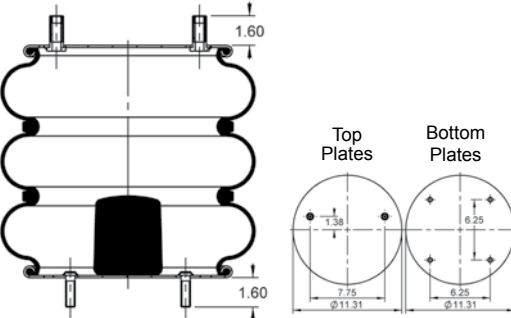
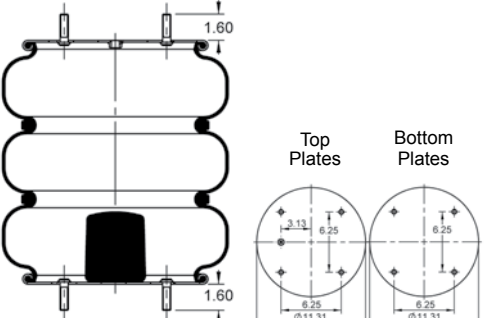
Product	Part No.	Applications	Bellows No.
	AS78080	Continental Hendrickson 13157 SAF Holland 570-07-808 EZ Ride 8030170 Loadguard SC2031 Peerless 0550-00030 Ridewell 1003587808C Truckstell 63640 Warren 8030170	FT 530-32
	AS78180	Continental Hendrickson 13041 Watson & Chalin AS-0025 SAF Holland 570-07-818 Silent Drive AS-7818 EZ Ride 8030180 Granning 1014 Loadguard SC2032 Navistar 554803C1	FT 530-32
	AS78380	EZ Ride	FT 530-35
	AS78390	Hendrickson Auxiliary W&C Trucks- Pushers Or Tags: WCAL-1200-DB (Ride) WCAL-1300 (Ride) WCAL-1600-DB (Ride - Original Design) WCAL-1900 (Ride - Original Design) W&C Steerables: WCHL-1100 (Ride) Cont. WCLWSL-1000-HLFL-TT (Ride) WCLWSL-1100-TTHL-ES (Ride)	FT 530-35

Note: See Air Spring Cross Reference immediately following the Air Spring Application Table.

Product	Part No.	Applications	Bellows No.
	<p>AS78430</p>	<p>Hendrickson Auxiliary Hendrickson: HLR Series ST-004 (Ride) HLR Series RW14A-X (Ride)</p>	<p>FT 530-35</p>
	<p>AS78440</p>	<p>Ridewell 1003587844C</p>	<p>FT 530-35</p>
	<p>AS78450</p>	<p>EZ Ride</p>	<p>FT 530-35</p>
	<p>AS78460</p>	<p>Hendrickson Auxiliary Hendrickson: HLR Series ST-031 (Ride)</p>	<p>FT 530-35</p>

Note: See Air Spring Cross Reference immediately following the Air Spring Application Table.

Product	Part No.	Applications	Bellows No.
	<p>AS78470</p>	<p>Hendrickson Auxiliary Hendrickson: HLR Series RT14D-X (Truck) (Ride) HLR Series RW14B-X&14C-X (Trailer) (Ride)</p>	<p>FT 530-35</p>
	<p>AS78480</p>	<p>Superior Hendrickson 13047 Suspensions Inc. 201496</p>	<p>FT 530-35</p>
	<p>AS78500</p>	<p>HS Industries/ Link Histeer 10301 Suspensions, Inc 200177 Watson & Chalin AS-0086</p>	<p>FT 530-35</p>
	<p>AS78550</p>	<p>Granning Reyco: 20018-01 18813-01 Binkley XB-SPN-053-37</p>	<p>FT 530-35</p>
	<p>AS78590</p>	<p>Hendrickson Aux. 001285</p>	<p>FT 530-35</p>

Note: See Air Spring Cross Reference immediately following the Air Spring Application Table.

CHASSIS

Product	Part No.	Applications	Bellows No.
	<p>AS78620</p>	<p>Hendrickson Auxiliary Hendrickson: HLUH (Ultra High Lift) (Ride)</p>	<p>FT 530-35</p>
	<p>AS78970</p>	<p>n/a</p>	<p>FD 200-22</p>
	<p>AS79940</p>	<p>Watson & Chalin AS-0019-1F</p>	<p>FT 330-29</p>
	<p>AS79950</p>	<p>Watson & Chalin AS-0048-1F</p>	<p>FT 330-29</p>
	<p>AS79960</p>	<p>Granning: 8221 702932-01</p>	<p>FT 330-29</p>

Note: See Air Spring Cross Reference immediately following the Air Spring Application Table.

CHASSIS

Product	Part No.	Applications	Bellows No.
	<p>AS79980</p>	<p>Hendrickson Aux. 001560</p>	<p>FT 330-29</p>
	<p>AS80060</p>	<p>Superior</p>	<p>FT 330-29</p>
	<p>AS80080</p>	<p>Hendrickson Auxiliary W&C Steering Liftables: LWSTL-1100 (Ride) W&C Liftables: TL-9000-16B (Ride) TL-9000-17.5/16.5 (Ride) TL-9000-19, 21, 24, 30 (Ride) W&C Tru Track (Ride) W&C Trucks- Pushers Or Tags: WCAL-1200-IS (Ride) W&C Steerables: WCSL-1100-LR, SR, SSR (Ride) WCSL-1100-LP (Ride) Cont. WCLWSL-1100-LW (Ride) WCLWSL-1100-SSR-LW (Ride)</p>	<p>FT 330-29</p>
	<p>AS80100</p>	<p>Oshkosh Ridewell: 1003588010C S-5844C Loadguard SC2119</p>	<p>FT 330-29</p>

Note: See Air Spring Cross Reference immediately following the Air Spring Application Table.

CHASSIS

Product	Part No.	Applications	Bellows No.
	AS80160	Ridewell 1003588016C	FT 330-29
	AS80180	HS Industries/ Link Watson & Chalin AS-0075 Rayco 93AR Hyster 10303 Loadguard SC2131 Spring Valley AS-4434	FT 330-29
	AS80250	Watson & Chalin AS-0019 Silent Drive AS-8025 Loadguard SC2130	FT 330-29
	AS80270	HS Industries/ Link Hyster 8029 Suspensions, Inc 200117 Silent Drive AS8027	FT 330-29
	AS80300	Ridewell 1003588030C	FT 330-29

Note: See Air Spring Cross Reference immediately following the Air Spring Application Table.

CHASSIS

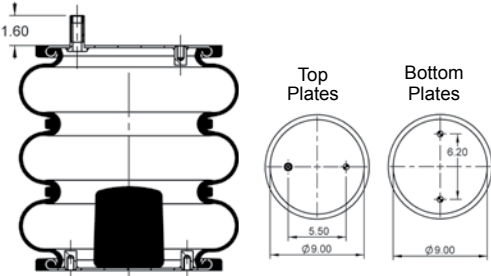
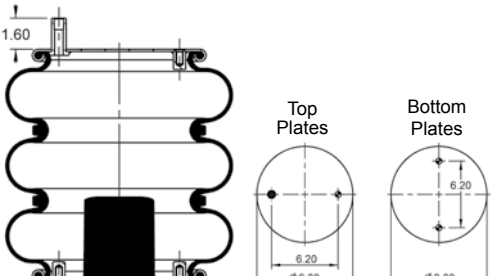
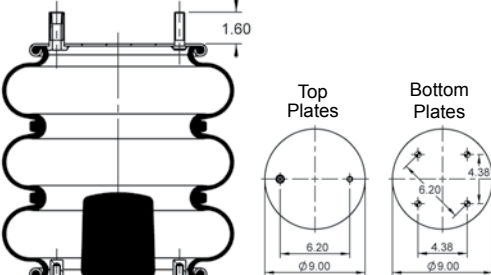
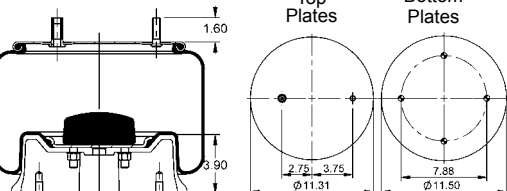
Product	Part No.	Applications	Bellows No.
	AS80320	Hendrickson AuxiliaryW&C Steering Lift-ables: STL-1100 Tru-Track (Ride) W&C Liftables TL-800 (Ride) TL-8100 (Ride) W&C Trucks- Pushers Or Tags: WCAL-800 (Ride) W&C Steerables: WCSL-1100-RO (Ride) WCLWSL-1100 Tru Track (Ride) WCLWSL-1100-TT-LP (Ride)	FT 330-29
	AS80321	Watson & Chalin AS-0048	FT 330-29
	AS80330	Hendrickson Auxiliary Hendrickson: HLN (Truck) (Ride) HLP (Ride) HLU (Ride) HLUS (Ride) HLUR (Ride)	FT 330-29
	AS80500	Hendrickson Auxiliary Hendrickson: HT-300T(All) T-17-141, 174, 284 T-15-140, 150, 172,244, 324, 376 HL-015 (Ride) W&C Trailer: TA-300-15, 16, 17, 22, 23B TA-300FM-16B TA-5000-DB-24, -DB-30, -F-24 TA-525DB, TA-525FS	11 10.5C-16

Note: See Air Spring Cross Reference immediately following the Air Spring Application Table.

Product	Part No.	Applications	Bellows No.
	AS80510	Ridewell 1003888051C Hendrickson Canada B-12514-013 Reyco 23631-013 Watson & Chalin AS-0039	11 10.5C-16
	AS80520	Hendrickson Canada B-12514-012 Watson & Chalin: AS-0078 AS0039	11 10.5C-16
	AS80530	Neway Powered Truck: ARDTB-125-6A ARDTB-125-6B	11 10.5C-16
Image Not Available	AS80531	Gillig Phantom (Metro) - Rear Gillig 53-20415-0001	11 10.5C-16
	AS80880	Ridewell 1003588088C	11 10.5-15
	AS80910	Hendrickson (Trailer) Hendrickson: Intraax AA250T(Reuse Metal Disk) Van Traax HKA-250 (Reuse Metal Disk)	11 10.5A-16

Note: See Air Spring Cross Reference immediately following the Air Spring Application Table.

Product	Part No.	Applications	Bellows No.
	AS82010	Ridewell 1003588201C	9 10-12
Image Not Available	AS82030	Wabash SAF Holland 905-57-210 Meritor 2258-C-1459	9 10-12
	AS82040	Neway Trailer Air: NS-190-16 RL-196A (12)	9 10-12
	AS87080	Hendrickson (Trailer) Hendrickson: Van Traax HKA-200	10 10-16
	AS87090	Hendrickson (Trailer) Hendrickson: Intraax AA230T Van Traax HKA-180	10 10.5-15
	AS87100	Hendrickson (Trailer) Hendrickson: Slider Box HK-230	10 10-15

Note: See Air Spring Cross Reference immediately following the Air Spring Application Table.

Product	Part No.	Applications	Bellows No.
	AS87130	Hendrickson (Trailer) Hendrickson: Van Traax HKA-180	10 10-16
	AS87290	Meritor 202796	10 10.5AV-12
	AS87400	Reyco 23433-01	10 10-15
	AS87480	Neway Trailer Air: AR-250 (14, 15) RL-250-14, 15	10 10-21
	AS87490	Neway Trailer Air: AR-250 (12, 16, 17) RL-228-17 RL-250-12 RL-250-16, 17	10 10-21

Note: See Air Spring Cross Reference immediately following the Air Spring Application Table.

Product	Part No.	Applications	Bellows No.
	AS87520	Ridewell 1003588752C Watson & Chalin AS-0084 Suspensions Inc. 201642	10 10-15
	AS87550	Hendrickson (Trailer) Hendrickson: Slider Box HK-190T	10 10-15
	AS87740	Hendrickson S25873	11 10.5-21
	AS87790	Neway SAF Holland 905-57-163	11 10.5-19
	AS87800	Neway SAF Holland 905-57-162	11 10.5-19

Note: See Air Spring Cross Reference immediately following the Air Spring Application Table.

Product	Part No.	Applications	Bellows No.
	<p>AS87810</p>	<p>Neway SAF Holland 905-58-205</p>	<p>11 10.5-19</p>
	<p>AS87820</p>	<p>Ridewell 1003588782C</p>	<p>10 10-15</p>
	<p>AS88020</p>	<p>Neway SAF Holland 905-57-170 Ridewell 1003588802C</p>	<p>9 10-14</p>
	<p>AS88030</p>	<p>Neway Trailer Air: NS-190 (18)</p>	<p>9 10-14</p>
	<p>AS88050</p>	<p>Ridewell 1003588805C</p>	<p>9 10-14</p>

Note: See Air Spring Cross Reference immediately following the Air Spring Application Table.

Product	Part No.	Applications	Bellows No.
	AS88060	Ridewell 1003588806C	9 10-14
	AS88100	Hagie Manufacturing	9 10-14
	AS88290	Loadguard SC2757 Volvo: 3934699 8079902 8084296 8097092 20505399	9 10-16
	AS88520	Peterbilt 03-07887	9 10-19
	AS88550	Reyco 23521-01	9 10-19

Note: See Air Spring Cross Reference immediately following the Air Spring Application Table.

Product	Part No.	Applications	Bellows No.
	<p>AS88560</p>	<p>Reyco 23521-02</p>	<p>9 10-19</p>
	<p>AS88640</p>	<p>Peterbilt 03-08716</p>	<p>9 10-19</p>
	<p>AS88880</p>	<p>Rowe Truck 0027</p>	<p>9 10-17.5</p>
	<p>AS89000</p>	<p>Reyco 17361-01 Prevost: 63-0079 63-0092 63-0104</p>	<p>9 9-12</p>
	<p>AS89010</p>	<p>Ridewell 1003588901C</p>	<p>9 9-12</p>

Note: See Air Spring Cross Reference immediately following the Air Spring Application Table.

CHASSIS

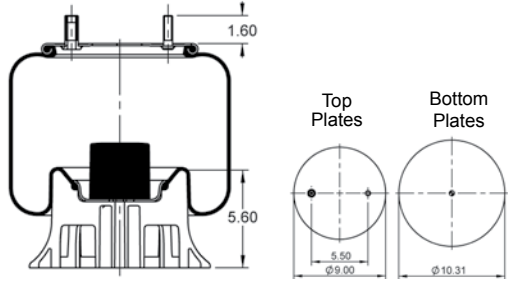
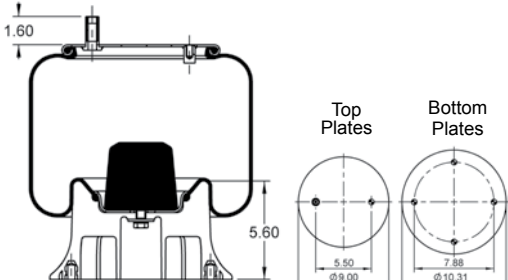
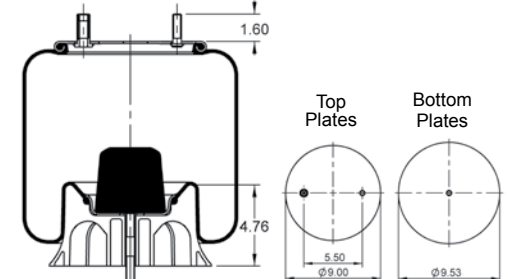
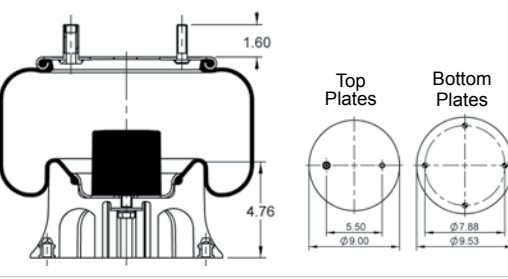
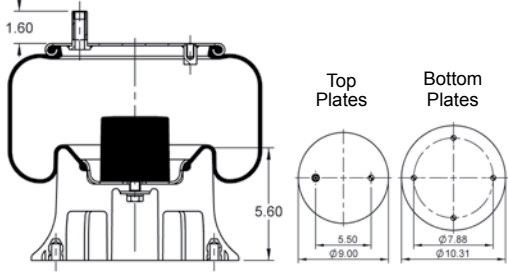
Product	Part No.	Applications	Bellows No.
	AS89030	Neway SAF Holland 905-57-169	9 10-17.5
Image Not Available	AS89190	Ridewell 1003588919C	9 9-14
	AS89240	Ridewell 1003588624C	9 10-16
	AS89270	Watson & Chalin AS-0062	9 10-16
	AS89300	Ridewell 1003588930C	9 10-12
	AS89320	Reyco 22241-01	9 10-12

Note: See Air Spring Cross Reference immediately following the Air Spring Application Table.

Product	Part No.	Applications	Bellows No.
	<p>AS89340</p>	<p>Hendrickson Trailer S20228</p>	<p>9 10-12</p>
	<p>AS89440</p>	<p>Hendrickson (Trailer) Hendrickson: HT-190U</p>	<p>9 10-17.5</p>
	<p>AS89490</p>	<p>Neway SAF Holland 905-57-150</p>	<p>9 10-17.5</p>
	<p>AS89610</p>	<p>Reyco 23377-01</p>	<p>9 10-10</p>
	<p>AS89630</p>	<p>Ridewell 1003588963C</p>	<p>9 10-10</p>

Note: See Air Spring Cross Reference immediately following the Air Spring Application Table.

CHASSIS

Product	Part No.	Applications	Bellows No.
	AS89640	Reyco 21598-01	9 10-10
	AS89760	Reyco 21055-01	9 10-10
	AS89860	Ridewell 1003588986C	9 10-10
	AS90040	Watson & Chalin AS-0043	9 10-16
	AS90080	Ridewell 1003589008C	9 10-14

Note: See Air Spring Cross Reference immediately following the Air Spring Application Table.

Product	Part No.	Applications	Bellows No.
	AS90100	Hendrickson (Trailer) Hendrickson: T-4-392	9 10-14
	AS90110	Hendrickson Trailer S2307	9 10-14
	AS90260	Peterbilt: 03-06213 03-07111	9 10-16
	AS90290	Ridewell 1003589029C	9 10-10
	AS90310	Peerless 0550-00051	9 10-10
	AS90330	Neway SAF Holland: 905-57-012 900-44-198 Loadguard SC2779	9 10-10

Note: See Air Spring Cross Reference immediately following the Air Spring Application Table.

Product	Part No.	Applications	Bellows No.
	<p>AS90390</p>	<p>FAB TEK Hendrickson: T-6-062, 295, 370, 422 TDC-014 Neway Powered Truck: ARL-20-D, -US Neway Trailer Air: AR-41, 45, 45-1 AR-50-US, -F, -F-1, -F-2 AR-51-US ARL-20-D, -US W&C Trailers: TA-280-D</p>	<p>9 10-10</p>
	<p>AS90530</p>	<p>Continental Hendrickson 13158 Watson & Chalin AS-0095 SAF Holland 570-09-053 EZ Ride 8030192 Fruehauf UCE-1304-2 Loadguard SC2457 Ridewell 1003589053C</p>	<p>9 10-12</p>
	<p>AS90590</p>	<p>Hutchins H-1913-1</p>	<p>9 10-14</p>
<p>Image Not Available</p>	<p>AS90591</p>	<p>Flxible (Metro) - Front Flxible: 97-2410-00006 97-2410-1 97-2410-2 97-2410-3 97-2410-4 97-2410-5 97-6693-1</p>	<p>9 10-14</p>

Note: See Air Spring Cross Reference immediately following the Air Spring Application Table.

CHASSIS

Product	Part No.	Applications	Bellows No.
	AS90600	Air Spring for New Flyer 000065, 014635 (Composite)	9 10-14
	AS90630	Navistar 359519C1	9 10-14
	AS90680	Navistar 350449C1	9 10-14
	AS90690	Peterbilt: 03-02456 03-04759 03-01649 03-06746 03-07112 03-02038 03-10042	9 10-14
	AS90700	Neway Trailer Air: AR-90-1 (12)	9 10-14

Note: See Air Spring Cross Reference immediately following the Air Spring Application Table.

CHASSIS

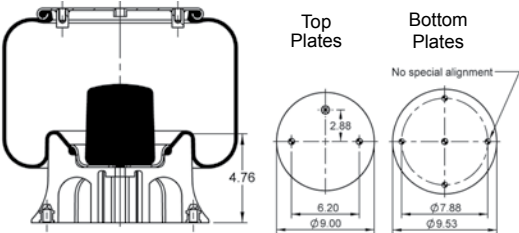
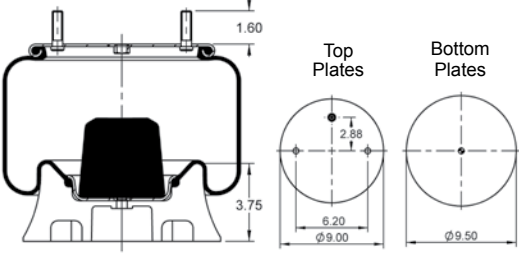
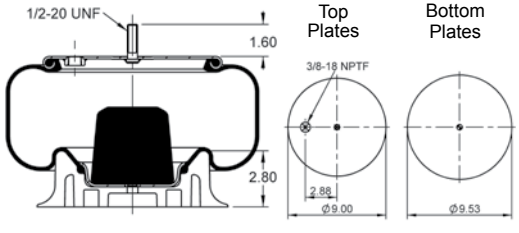
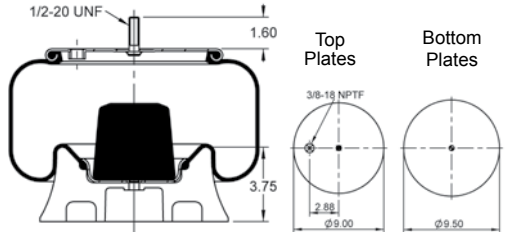
Product	Part No.	Applications	Bellows No.
	AS90710	FAB TEK (West Unit) Ridewell 1003589071C	9 10-14
	AS90750	Hutchins H-2007 SAF Holland 905-57-030	9 9-12
	AS90770	Fruehauf (Trailer) SAF Holland 507-09-077 Fruehauf: MFR-022354 UCB-44531 Loadguard SC2780	9 10-10
	AS90780	Fruehauf (Trailer) Fruehauf: UCB-9668-1 MFR-022355	9 10-12

Note: See Air Spring Cross Reference immediately following the Air Spring Application Table.

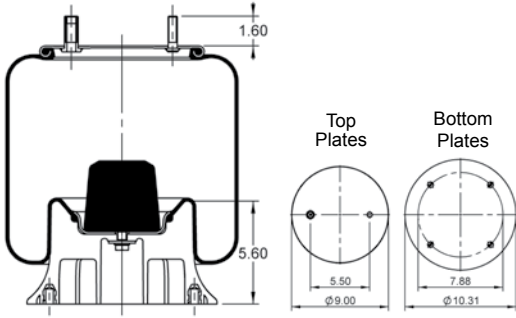
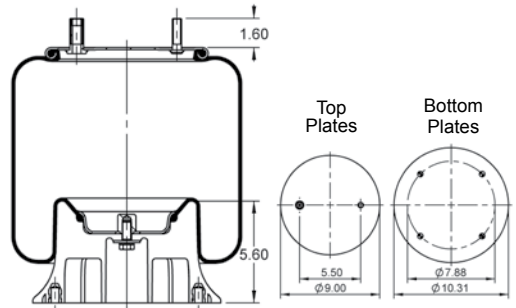
Product	Part No.	Applications	Bellows No.
	<p>AS90820</p>	<p>Hendrickson Auxiliary Hendrickson: T-9-106, 278, 313 TMB-14-120 TMB-17-135 Neway Non-Powered Truck: ART-500-B, -B1, 500-US, 500-US-A ART-505-B, B-1 ART-505-C, C-1 ART-541-B ART-550-US, -A ARTA TC-120-D TC-120-D Neway Powered Truck: ARD-125, -6, 244-6 ARDST-123, 244-6 ARD-120-6 ARD-238-6 ARD-125, -8, 244-8 ARD-165-A, -B ARD-190-B Neway Trailer Air: AR-120, 120-US, 120-US-F AR-75-6, 9 AR-165-US W&C Liftables: WB-2500-7.5, -9 W&C Trailers: TA-2075-9</p>	<p>9 10-16</p>
	<p>AS90830</p>	<p>Granning W&C Trucks- Pushers Or Tags: WCAL-1600-DB (Ride - Current Design)</p>	<p>9 10-16</p>

Note: See Air Spring Cross Reference immediately following the Air Spring Application Table.

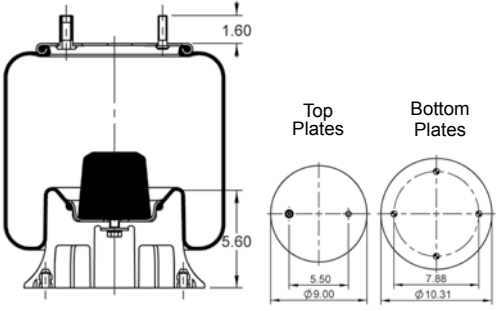
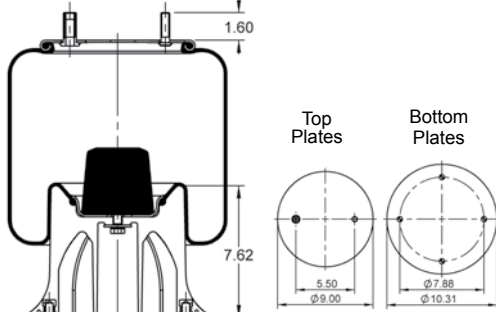
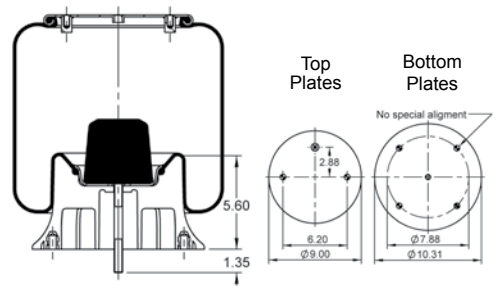
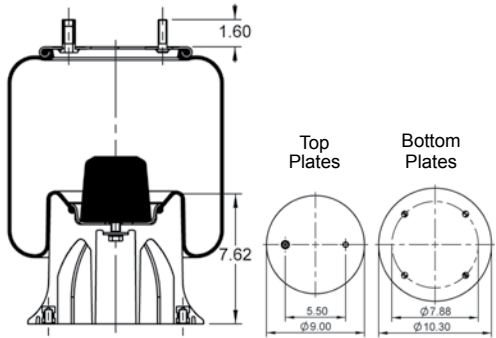
Product	Part No.	Applications	Bellows No.
	AS90920	Hendrickson (Trailer) Hendrickson: T-9-325, 390	9 10-16
	AS90930	Neway: ARD-125-6, 244-6	9 10-16
	AS90960	Fruehauf (Trailer) Hendrickson 13049 SAF Holland 570-09-096 Fruehauf UCE-1304-1 Loadguard: SC2051 SC2765	9 10-16
Image Not Available	AS90970	Navistar: 426213C-1 4545910C-1 442307C91 4545889C-1	9 10-16
	AS91010	Neway Trailer Air: AR-75-12, 1-12 AR-120L, 120-US-L-1, 2, 3 Neway Non-Powered Truck: ART-550-US-1, -2, -3 ART-551-B-1, -2, -3 ART-551-US-1, -2, -3 ART-555-B-1, -2, -3 ART-555-C-1, -2, -3 W&C Trailers: TA-2075 (12)	9 10-16

Note: See Air Spring Cross Reference immediately following the Air Spring Application Table.

Product	Part No.	Applications	Bellows No.
Image Not Available	AS91020	n/a	
	AS91050	Granning Hendrickson: HLQ Series QU22C-X&QU22D-X T-6-071 W&C Liftables: WB-2500-6 W&C Trailers: WCTA-2075 (6)	9 10-12
	AS91130	Hendrickson	9 10-12
	AS91160	Pezzani	11 10.5-17
	AS91180	Ridewell 1003589118C	9 10-12

Note: See Air Spring Cross Reference immediately following the Air Spring Application Table.

CHASSIS

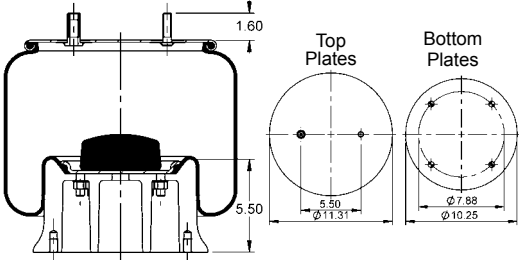
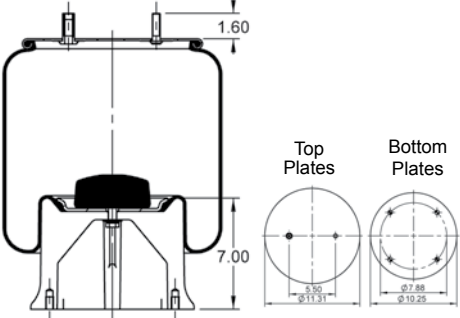
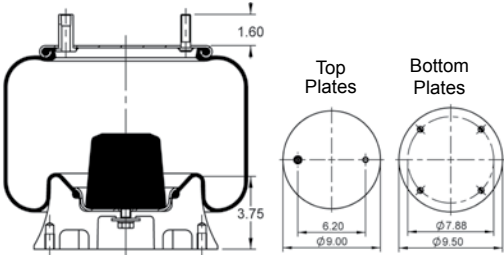
Product	Part No.	Applications	Bellows No.
	<p>AS91210</p>	<p>Neway Trailer Air: AR-70-9, 14 AR-70A-9, 14 AR-75-12, 1-12 AR-80-6.75 AR-85-A AR-125-US-F ARDST-246 Neway Powered Truck: ARDST-246-6, ARDSTM/L-246-6 ARDST-250 (W.Star) ARDSTML-123, 246 (6) W&C Trailers: TA-300-9 TA-3090-14</p>	<p>11 10.5-17</p>
	<p>AS91220</p>	<p>Hendrickson, Neway Hendrickson: T-30-US-9, 17 HT-300U (All) T-9-084 Neway Trailer Air: AR-955-9, 12, 14, 17 AR-955-9-HD, 12-HD, 14-HD, 17-HD AR-955A-9, 12, 14, 17 AR-955A-9-HD, 12-HD, 14-HD, 17-HD AR-95-9, 12, 14, 17 AR-95-9-HD, 12-HD, 14-HD, 17-HD AR-95A-9, 12, 14, 17 AR-95A-9-HD, 12-D-HD, 14-HD, 17-HD W&C Trailer: TA-300U-12, 14, 17, 9 TA-3090U-17, 19 Hendrickson: T-30-US-17 W&C Trucks- Pushers Or Tags WCAL-1900 (Ride - Current Design)</p>	<p>11 10.5-21</p>
	<p>AS91270</p>	<p>New Flyer 009594</p>	<p>9 10-14</p>

Note: See Air Spring Cross Reference immediately following the Air Spring Application Table.

Product	Part No.	Applications	Bellows No.
---------	----------	--------------	-------------

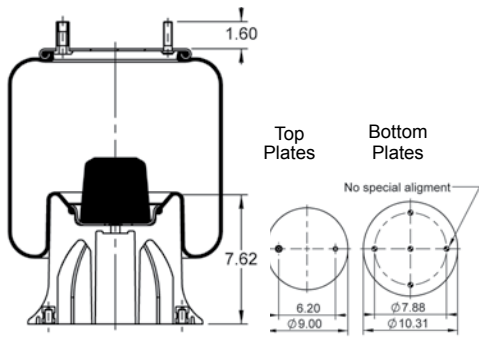

AS91300

Fruehauf (Trailer)Hendrickson 13161
 SAF Holland 570-09-130
 Fruehauf:
 UCE-9393-1
 UCE-9393-3
 Loadguard SC2102

11 10.5-19

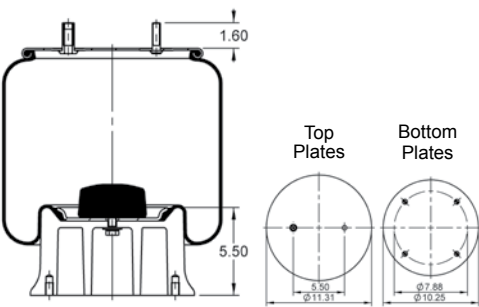

AS91340

Neway Trailer Air:
 AR-80-9
 AR-80-9-WST

11 10.5-19

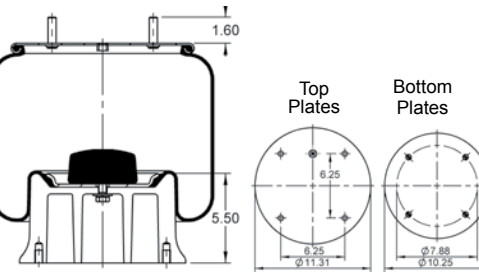

AS91350

Unit RigDart 21-4048
 Unit Rig 1016034

11 10.5-17

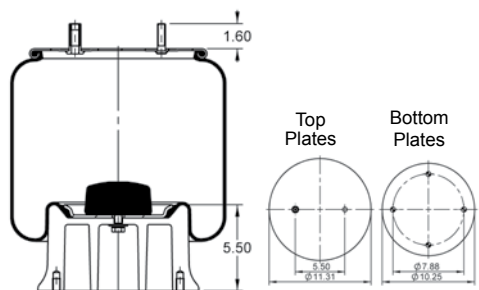

AS91380

Neway Trailer Air:
 AR-90-9FM

11 10.5-19

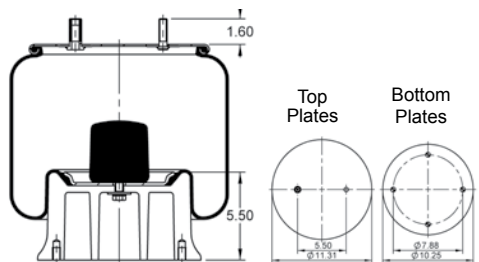

AS91440

Neway
 SAF Holland:
 905-57-155
 905-57-323

11 10.5-17

Note: See Air Spring Cross Reference immediately following the Air Spring Application Table.

CHASSIS

Product	Part No.	Applications	Bellows No.
	AS91480	Hendrickson 13053 Loadguard SC2042 Navistar: 1681743C1 554778C1 Peerless 0550-00070	11 10.5-17
	AS91490	Hendrickson 13045 SAF Holland 570-09-149 Gillig 53-13188 Loadguard: SC2043 SC2112 Navistar: 554776C1 1681741C1 Peerless 0550-00010	11 10.5-17
	AS91520	Hendrickson: 12514-004 12514-011 2063 SAF Holland: 905-57-005 905-57-069 Ridewell 1003589158C	11 10.5-21
	AS91560	Hendrickson Trailer S7128 City Welding Peerless 0550-00080	11 10.5-21

Note: See Air Spring Cross Reference immediately following the Air Spring Application Table.

Product	Part No.	Applications	Bellows No.
	AS91580	Hendrickson Canada Hendrickson: T-9-175 Neway Trailer Air: AR-125-L AR-125-US-L-1, 2, 3	11 10.5-21
	AS91640	R&S Truck & Body 1090326	11 10.5-17
Image Not Available	AS916N1	n/a	n/a
	AS91770	Hendrickson 2065 Watson & Chalin AS-0010 SAF Holland 905-57-003 Loadguard SC2046 Navistar 554779C1 Ridewell 1003589177C R&S Truck & Body 1090216	11 10.5-17
	AS91790	Columbia Trailer	11 10.5-17
	AS91920	Hendrickson Trailer S6195 SAF Holland: 905-57-086 905-57-108 Watson & Chalin: AS-0038 AS-0046	9 10-19

Note: See Air Spring Cross Reference immediately following the Air Spring Application Table.

CHASSIS

Product	Part No.	Applications	Bellows No.
	<p>AS91930</p>	<p>Neway Powered Truck: ARDST-244-6 ARDST-246 (8.75)</p>	<p>9 10-16</p>
	<p>AS91940</p>	<p>Hendrickson 13163 Watson & Chalin AS-0101 SAF Holland 570-09-194 Loadguard SC2786 Peterbilt 03-05107</p>	<p>9 10-16</p>
	<p>AS91990</p>	<p>Pezzani</p>	<p>11 10.5-21</p>
	<p>AS92000</p>	<p>Hendrickson Trailer S3839 Ridewell 1003589200C</p>	<p>11 10.5-15</p>
	<p>AS92030</p>	<p>Hendrickson Trailer S2694</p>	<p>9 10-19</p>

Note: See Air Spring Cross Reference immediately following the Air Spring Application Table.

CHASSIS

Product	Part No.	Applications	Bellows No.
Image Not Available	AS92040	Ravens Trailer	11 10.5-15
Image Not Available	AS92100	Granning 2577	n/a
Image Not Available	AS92110	Granning 2692	9 10-16
	AS92130	Navistar: 166058C1 501559C2 501559C-1	9 10-16
	AS92150	Hendrickson Trailer S3648	11 10.5-15
	AS92160	City Welding	11 10.5-15
	AS92180	Neway Watson & Chalin AS-0073 SAF Holland 905-57-209 Loadguard SC2782 Ridewell 1003589218C Suspensions Inc 201222	11 10.5-15
	AS92190	Volvo W&C Truck: AL-2200, -LW, -SSR, -RO (Ride)	9 10-16

Note: See Air Spring Cross Reference immediately following the Air Spring Application Table.

Product	Part No.	Applications	Bellows No.
	AS92210	Load Air P60733	11 10.5-17
	AS92230	Hendrickson 48195-2 SAF Holland 570-09-223 Reyco: 12884-01 12884-01A	9 10-16
	AS92270	Hendrickson Trailer S2924 Hendrickson 48195-1	9 10-16
	AS92280	Hendrickson B-3411	9 10-16
	AS92380	Hendrickson S5060	9 10-19

Note: See Air Spring Cross Reference immediately following the Air Spring Application Table.

Product	Part No.	Applications	Bellows No.
	<p>AS92400</p>	<p>Hendrickson Trailer S3842 Hendrickson Canada S10352</p>	<p>9 10-19</p>
	<p>AS92410</p>	<p>Hendrickson (Trailer) Hendrickson: MT-45</p>	<p>9 10-19</p>
	<p>AS92430</p>	<p>Neway Trailer Air: AR-90-14, 15, 16, 17 AR-92-9, 10 RLU-228 (9, 10) -4 W&C Liftables: TLC-2590-12, 14, 15 WB-251-7.5, -9.0 WB-280-9.0 W&C Trailers: TA-250U-12, 14, 5.5, 7.5, 7.5FS, 9 TA-251-10, 12, 6.5 FS, 7.5, 8FS, 9.0, 9.0FS TA-2590-12, 14, 15 TA-791-17-B TL-2200LP (Ride) TL-2590-12, 14, 15 TL-2590-14, 17 HD WCTA-251 WCTA-280 W&C Trucks- Pusher Or Tags, Cont. WCAL-2200-LP (Ride)</p>	<p>9 10-19</p>

Note: See Air Spring Cross Reference immediately following the Air Spring Application Table.

Product	Part No.	Applications	Bellows No.
	AS92450	Ridewell 1003589245C	9 10-19
	AS92500	Ridewell 1003589250C Watson & Chalin AS-096 SAF Holland 570-09-250 Loadguard SC2049	9 10D-21
	AS92520	Ridewell 1003589252C	9 10D-21
	AS92560	Hendrickson 49160-OE	9 10D-21

Note: See Air Spring Cross Reference immediately following the Air Spring Application Table.

Product	Part No.	Applications	Bellows No.
	AS92650	Hendrickson (Trailer) Hendrickson: HT-250T HT-250U (Majority Of Versions) HT-250U-Y (Majority Of Versions) HT-250US	9 10-19
	AS92690	Oshkosh RX-08-03	9 10D-21
	AS92700	Hendrickson (Trailer) Hendrickson: HT-230T HT Dolly HT-230T Slider Box HS-230 HT-190T(Other Versions)	9 10-13.5
	AS92740	Ridewell 1003589274C	9 10B-17.5
	AS92750	Ridewell 1003589275C SAF Holland 570-09-275 Loadguard SC2464	9 10B-17.5

Note: See Air Spring Cross Reference immediately following the Air Spring Application Table.

Product	Part No.	Applications	Bellows No.
	<p>AS92770</p>	<p>Ridewell 1003589277C Reyco 24556-01</p>	<p>11 10.5-15</p>
	<p>AS92870</p>	<p>Hendrickson (Truck) Hendrickson: HA400 (1991+) HA460 (1991+) HA360 (1991+)</p>	<p>9 10-18.5</p>
	<p>AS92910</p>	<p>Neway Trailer Air: RL-196-17, 196A-17</p>	<p>9 9K-15</p>
	<p>AS92930</p>	<p>Neway Trailer Air: RL-196-14, 196A-14</p>	<p>9 9K-15</p>

Note: See Air Spring Cross Reference immediately following the Air Spring Application Table.

Product	Part No.	Applications	Bellows No.
	AS92940	Neway Trailer Air: RL-196-12	9 9K-15
	AS92950	Neway Hendrickson: HT-250U Neway Trailer Air: RL-196-15, 16, 196A-15, 16	9 9K-15
	AS92960	Loadguard SC2760 Volvo: 8061151 8169868	9 10-16
	AS92970	Hendrickson (Truck) Hendrickson: HAS40LH	9 10-18.5

Note: See Air Spring Cross Reference immediately following the Air Spring Application Table.

CHASSIS

Product	Part No.	Applications	Bellows No.
	AS92990	Hendrickson (Trailer) Hendrickson: HT-250U HT-250US	9 10-16
Image Not Available	AS93020	Hendrickson Canada B-12514-003	9 10-12
	AS93040	Neway Trailer Air: AR-90-1-15, 16	9 10-16
	AS93070	Neway Trailer Air: AR-41, 45, 45-1 (Current Design)	9 10-10
	AS93080	Neway SAF Holland 905-57-089 Reyco 176360-01	9 10-10

Note: See Air Spring Cross Reference immediately following the Air Spring Application Table.

Product	Part No.	Applications	Bellows No.
	AS93200	Neway SAF Holland 905-57-099 Silent Drive AS-9320 Loadguard SC2774	9 10-21
	AS93210	Watson & Chalin AS-0036	9 10-21
	AS93250	Neway SAF Holland 905-57-149 Gillig 87-17289	9 10-12
	AS93320	Reyco 20074-01	9 10-10
	AS93330	Reyco 20437-01	9 10-10

Note: See Air Spring Cross Reference immediately following the Air Spring Application Table.

Product	Part No.	Applications	Bellows No.
	AS93340	Ridewell 1003589334C	9 10-10
	AS93350	Hendrickson: 56917-1 56917-2	9 10-14
	AS93360	Watson & Chalin AS-0053	9 10-14
	AS93380	Silent Drive AS-9338	9 10-21
	AS93390	Hendrickson: S56808-2 S7250RH S7140LH	9 10-12

Note: See Air Spring Cross Reference immediately following the Air Spring Application Table.

Product	Part No.	Applications	Bellows No.
	<p>AS93420</p>	<p>Granning 2727</p>	<p>9 10-17.5</p>
	<p>AS93460</p>	<p>Neway Trailer Air: AR-75-12, 1-12 AR-92 (12) RLU-228 (12) -4 W&C Trailers: WCTA-251-12FS</p>	<p>9 10-19</p>
	<p>AS93480</p>	<p>McCullough (Trailer) SAF Holland 570-09-348 Loadguard SC2752</p>	<p>9 10-19</p>
	<p>AS93490</p>	<p>Hendrickson Trailer S8988 Reyco 17636-01</p>	<p>9 10-19</p>

Note: See Air Spring Cross Reference immediately following the Air Spring Application Table.

Product	Part No.	Applications	Bellows No.
	<p>AS93500</p>	<p>Watson & Chalin</p>	<p>9 10-19</p>
	<p>AS93620</p>	<p>Neway Trailer Air: AR-75-6, 9 AR-90-1-14, 17 W&C Trailers: WCTA-251 (6.5) WCTA-280 (6.5)</p>	<p>9 10-19</p>
<p>Image Not Available</p>	<p>AS93640</p>	<p>Watson & Chalin AS-0059 SAF Holland 905-57-124</p>	<p>9 10-16</p>
	<p>AS93650</p>	<p>Neway SAF Holland 905-57-159</p>	<p>9 10-12</p>
	<p>AS93660</p>	<p>Neway Trailer Air: NS-190</p>	<p>9 10-12</p>

Note: See Air Spring Cross Reference immediately following the Air Spring Application Table.

CHASSIS

Product	Part No.	Applications	Bellows No.
	AS93670	Hendrickson Auxiliary Hendrickson: HLM-1&2 (Ride) Hendrickson MTL-45&50 (Ride)	9 10-21
	AS9367A	Hendrickson S14249 Hendrickson Auxiliary 003319	9 10-21
	AS93700	Watson & Chalin W&C Liftables: TL-2200-9 Thru 20 (Ride) TL-2200-23 Thru 34 (Ride) TL-2200-SSR (Ride) W&C Truck: AL-2200-LP (Ride) SL-2200-13.5, -15 (Ride) W&C Trucks- Pushers Or Tags: WCAL-2200 (Ride) Cont. WCAL-2200-LW (Ride)	9 10-21
	AS93710	Navistar: 1670073C-1 2027911C-1 1670043C-1 1686386C-1	9 10-18.5

Note: See Air Spring Cross Reference immediately following the Air Spring Application Table.

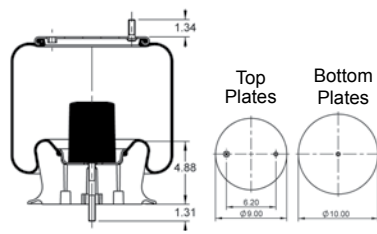
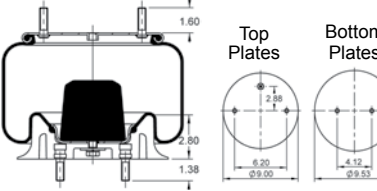
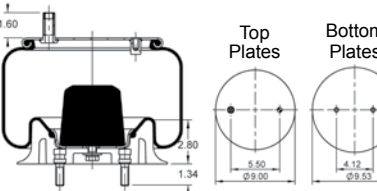
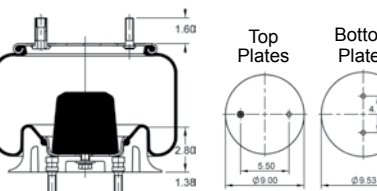
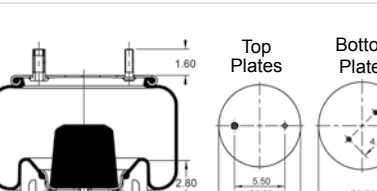
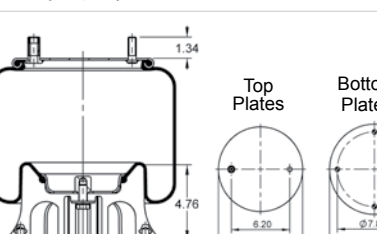
Product	Part No.	Applications	Bellows No.
Image Not Available	AS93730	Hendrickson (Truck) Hendrickson: HAS360 HAS400 HAS402 HAS460	9 10-18.5
	AS93750	Hendrickson: 50899-1 50899-2 Mack: 57QL414M 3645Q27	9 10-18.5
	AS93760	Monaco Coach: 8619 8108	9 9-12
	AS93770	Reyco 21054-01	9 9-12
	AS93780	Ridewell 1003589378C	9 9-12
	AS93790	SAF Holland 570-09-379 Loadguard SC2110 Navistar 1660694C1	9 9-12
	AS93850	n/a	9 9-14

Note: See Air Spring Cross Reference immediately following the Air Spring Application Table.

CHASSIS

Product	Part No.	Applications	Bellows No.
	AS93870	Ridewell 1003589387C	9 9-12
	AS93920	Hendrickson Trailer Granning 2727	9 10-16
	AS93940	Fruehauf (Trailer) Hendrickson S103522 Fruehauf UCD-9394-2	9 10-19
	AS94210	American Carrier 8003-003	9 9-12
	AS94220	Kenworth K-303-6 K-303-14 K-303-15	9 9-12
Image Not Available	AS94390	Hagie Manufacturing Flxible 6-336-200 Novabus 16374	9 9-14

Note: See Air Spring Cross Reference immediately following the Air Spring Application Table.

Product	Part No.	Applications	Bellows No.
	AS94400	Madsen	9 9-12
	AS94480	Ridewell 1003589448C	9 9-14
	AS94650	New Flyer 009865	9 9-14
	AS94660	Hendrickson (Truck) Hendrickson: HA360 (Pre-1991) HA400 (Pre-1991) HA460 (Pre-1991)	9 10-16
	AS94670	Ridewell 1003589467C	9 10-14
Image Not Available	AS94690	Gillig Bus Similar to AS94390	9 10-14

Note: See Air Spring Cross Reference immediately following the Air Spring Application Table.

Product	Part No.	Applications	Bellows No.
	AS94700	Neway SAF Holland 905-57-145	9 10-17.5
	AS94710	Neway SAF Holland: 905-57-146 905-57-182 905-57-177	9 10-17.5
	AS94720	Neway Powered Truck: AD-123, 246 (6.5, 8.75) AD-123, 246 (Ford)	9 10-17.5
	AS94730	Neway SAF Holland: 905-57-152 905-57-179 905-57-215	9 10-17.5
	AS94740	Reyco 20966-01 Everley RA 1954-11	9 10-16

Note: See Air Spring Cross Reference immediately following the Air Spring Application Table.

CHASSIS

Product	Part No.	Applications	Bellows No.
	AS94760	Reyco 20446-01	9 9-12
Image Not Available	AS94820	Neway Powered Truck: AD-200 (7)	9 10-14
	AS94830	Neway Powered Truck: AD-200 (8)	9 10-14
	AS94840	Neway SAF Holland 905-57-158	9 10-14
	AS94910	Neway SAF Holland 905-57-206	9 10B-17.5
	AS94960	Neway Powered Truck: AD-200 (9)	9 10-16

Note: See Air Spring Cross Reference immediately following the Air Spring Application Table.

Product	Part No.	Applications	Bellows No.
	AS95010	Holland Neway Powered Truck: AD-123, 246 (10) AD-200 (11)	9 10 -17.5
	AS95670	Navistar 2027913C1	9 10-14
	AS95680	Navistar 1675495C1	9 10-14
	AS95800	n/a	10 10-21
	AS96160	Kenworth K-303-16	9 9-12

Note: See Air Spring Cross Reference immediately following the Air Spring Application Table.

CHASSIS

Product	Part No.	Applications	Bellows No.
	<p>AS96190</p>	<p>Hendrickson (Trailer) Hendrickson: Intraax AA230L</p>	<p>9 9B-22</p>
	<p>AS96210</p>	<p>Hendrickson (Trailer) Hendrickson: Intraax AA230L</p>	<p>9 9B-20</p>
	<p>AS96220</p>	<p>Kenworth K-303-22</p>	<p>9 9-9</p>
	<p>AS96250</p>	<p>Kenworth K-303-25</p>	<p>9 9-10</p>
	<p>AS96260</p>	<p>Hendrickson (Trailer) Hendrickson: Intraax AA230L</p>	<p>9 9-16</p>

Note: See Air Spring Cross Reference immediately following the Air Spring Application Table.

CHASSIS

Product	Part No.	Applications	Bellows No.
Image Not Available	AS96340	Freightliner: 16-14263-000 16-14263-001	9 9-14
	AS96400	Hendrickson (Trailer) Hendrickson: HT-190T(Majority Of Versions) HT Dolly Slider Box HS-190T	9 10-12
	AS96430	Hendrickson 58995-2 (Freightliner)	9 10-16
	AS96440	Hendrickson (Trailer) Hendrickson: Intraax AA250L	9 10BP-16
	AS96450	Hendrickson (Trailer) Hendrickson: Intraax AA250L	9 10BP-22

Note: See Air Spring Cross Reference immediately following the Air Spring Application Table.

Product	Part No.	Applications	Bellows No.
	<p>AS96460</p>	<p>Hendrickson (Trailer) Hendrickson: Intraax AA250L</p>	<p>9 10BP-20</p>
	<p>AS96470</p>	<p>Hendrickson 58786-2 Mack 57QL417M</p>	<p>9 10-18.5</p>
	<p>AS96480</p>	<p>Navistar: 2027911C3 2027911C2 2027911C1</p>	<p>9 10-18.5</p>
	<p>AS96490</p>	<p>Neway SAF Holland 905-57-252</p>	<p>9 10-18.5</p>
	<p>AS96750</p>	<p>Kenworth K-303-28</p>	<p>9 9-10</p>

Note: See Air Spring Cross Reference immediately following the Air Spring Application Table.

CHASSIS

Product	Part No.	Applications	Bellows No.
	AS9780A	Freightliner (Aluminum Base) 16-16773-000 681-320-0017 A16-14004-000 16-13840-000 Loadguard SC2750 Volvo 85101151	9 10S-16
	AS9780P	Freightliner (Composite Base) 16-16773-000 681-320-0017 A16-14004-000 16-13840-000 Loadguard SC2750 Volvo 85101151	9 10S-16
	AS97970	Ridewell 1003589797C	9 10-14
Image Not Available	AS97980	Neway SAF Holland: 905-57-105 905-57-137	9 10-14
	AS99020	Neway SAF Holland 905-57-138	9 10-17.5
	AS99210	Neway Trailer Air: AR-92-8 AR-92-12, 14, 15, 16, 17, 18 AR-93-6, 7 AR-93-14 RLU-228 (6,7) -3 RLU-228 (8) -4 W&C Trailer: TA-791	9 10-17.5

Note: See Air Spring Cross Reference immediately following the Air Spring Application Table.

Product	Part No.	Applications	Bellows No.
	AS99220	Neway Trailer Air: AR-93 (9, 10) AR-93-17 RLU-228 (6, 7) -3 RLU-228 (9, 10) -3	9 10-17.5
	AS99230	Neway Trailer Air: AR-93 (8) AR-93-15, 16 RLU-228 (8) -3 RLU-228 (8) -3	9 10-17.5
	AS99350	Neway Trailer Air: RL-228 (17)	9 10-17.5
	AS99360	Neway Trailer Air: RL-228-14, -15, -16	9 10-17.5
	AS99420	Neway SAF Holland 905-57-142	9 10-17.5

Note: See Air Spring Cross Reference immediately following the Air Spring Application Table.

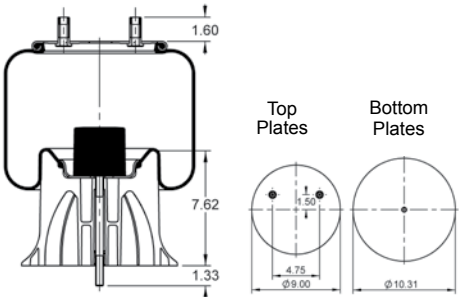
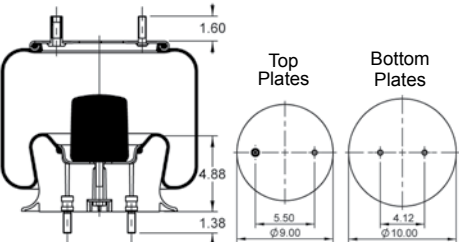
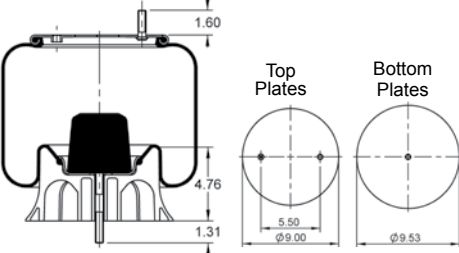
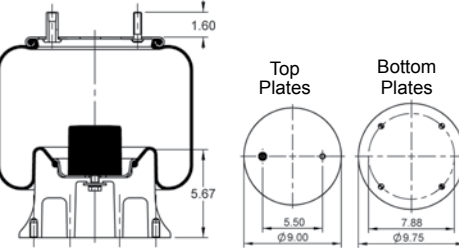
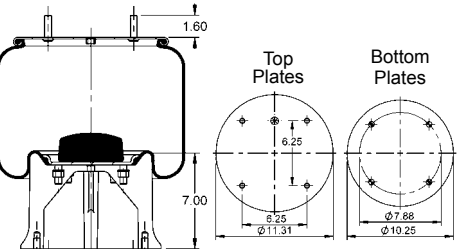
Product	Part No.	Applications	Bellows No.
	AS99430	Neway SAF Holland 905-57-143	9 10-17.5
	AS99440	Reyco 12884-01	9 10-16
	AS99470	Reyco SAF Holland 905-57-143	9 10-17.5
	AS99480	Neway Lift Suspension: VS-14-4 (V-Steer-1) (Ride)	9 10-17.5
	AS99610	Ridewell 1003589961C	11 10.5-17

Note: See Air Spring Cross Reference immediately following the Air Spring Application Table.

Product	Part No.	Applications	Bellows No.
	AS89970	Air Spring for Blue Bird 800 961425, 1263581/ El Dorado 71040301/ Flxible 6 336 196	6 6.5B-11
	AS99740	Timpte (Trailer) SAF Holland 905-57-332	9 10-17.5
Image Not Available	AS99820	Flxible	n/a
	ASA4630	Raydan: AL460 AL520 211-00-030	9 10-12
	ASA8010	Cush Reyco	9 10-19
	ASC7750	Hendrickson 005079	FD 110-17A
Image Not Available	ASP5215	n/a	n/a

Note: See Air Spring Cross Reference immediately following the Air Spring Application Table.

Product	Part No.	Applications	Bellows No.
	<p>ASP8740</p>	<p>SAF-Holland: 90557306 90557363 90557372 50857000</p>	<p>9 10-13.5</p>
	<p>ASP8890</p>	<p>Navistar 3541731C1</p>	<p>9 10B-19.5</p>

Note: See Air Spring Cross Reference immediately following the Air Spring Application Table.



CAB, SLEEPER & SEAT AIR SPRINGS

FEATURES & BENEFITS

- " Chemically-formulated vulcanized material withstands ozone effects that lead to air loss
- " 100% leak tested to ensure reliable performance

RELATED PARTS

It is highly recommended to replace shocks and height control valves (if applicable) when replacing the suspension air springs.



CAB, SLEEPER & SEAT AIR SPRINGS

Chemically-formulated to resist cracking and air loss, TRP® Air Springs for cab, sleeper and seat air suspensions maintain a smooth ride and handling of the cab and sleeper. Keeping the air suspension in working order prevents damage to expensive cab components and helps decrease driver fatigue.

CROSS REFERENCE

TRP®	Brands	Suspension Type	Firestone
AS72060	Freightliner	Cab	W02-358-7206
AS70870	Freightliner	Cab	W02-358-7087
AS72150	Freightliner	Cab	W02-358-7215
AS72050	Freightliner & Western Star	Cab	W02-358-7205
AS72010	Freightliner & Sterling	Cab	W02-358-7201
AS71080	Navistar	Cab	W02-358-7108
AS70010	Navistar, Volvo, GMC	Cab	W02-358-7001
AS70860	Ford	Cab	W02-358-7086
AS70610	Seat	Seat	W02-358-7061
AS71520	Seat	Seat	W02-358-7152
AS70350	Seat	Seat	W02-358-7035

Scan the code for more information.
Get the free mobile app at <http://gettag.mobi>



CAB, SLEEPER & SEAT AIR SPRINGS



Table 7-72: Suspension & Ride Control - Cab, Sleeper & Seat Air Springs

Part No.	Description	Applications
AS70010	Air Spring	Link: 1102-0020 1102-0023 Wise
AS70350	Air Spring	Sears / Duraform S9383
AS70610	Air Spring	C.E. White
AS70860	Air Spring	Link 1102-0025
AS70870	Air Spring	Freightliner FLD
AS71080	Air Spring	Link 1102-0075 Milsco 07067A
AS71520	Air Spring	Knoedler 100095-000
AS72010	Air Spring	Link: 1102-0020 1102-0023 Comfort RideWise
AS72050	Air Spring	Freightliner 66003-3406
AS72060	Air Spring	Freightliner 18-29919-000
AS72150	Air Spring	Freightliner 18-52651-000

CROSS REFERENCE FOR AIR SPRINGS

Table 7-73: Cross Reference for Air Springs

OEM Part No.	TRP® Part No.	Page No.
FIRESTONE		
W01-358-5503	AS55030	7-45
W01-358-6258	AS62580	7-45
W01-358-6789	AS67890	7-45
W01-358-6799	AS67990	7-45
W01-358-6800	AS68000	7-46
W01-358-6801	AS68010	7-46
W01-358-6803	AS68030	7-46
W01-358-6805	AS68050	7-46
W01-358-6808	AS68080	7-46
W01-358-6883	AS68830	7-47
W01-358-6886	AS68860	7-47
W01-358-6890	AS68900	7-47
W01-358-6897	AS68970	7-48
W01-358-6902	AS69020	7-48
W01-358-6905	AS69050	7-49
W01-358-6908	AS69080	7-49
W01-358-6910	AS69100	7-49
W01-358-6926	AS69260	7-49
W01-358-6927	AS69270	7-49
W01-358-6935	AS69350	7-50
W01-358-6940	AS69400	7-50
W01-358-6941	AS69410	7-50
W01-358-6943	AS69430	7-50
W01-358-6944	AS69440	7-50
W01-358-6945	AS69450	7-51
W01-358-6946	AS69460	7-51
W01-358-6947	AS69470	7-51
W01-358-6948	AS69480	7-51
W01-358-6949	AS69490	7-51
W01-358-6960	AS69600	7-52
W01-358-6962	AS69620	7-52
W01-358-6994	AS69940	7-52
W01-358-7008	AS70080	7-52
W01-358-7009	AS70090	7-52

OEM Part No.	TRP® Part No.	Page No.
W01-358-7088	AS70880	7-53
W01-358-7094	AS70940	7-53
W01-358-7096	AS70960	7-53
W01-358-7103	AS71030	7-53
W01-358-7104	AS71040	7-53
W01-358-7105	AS71050	7-53
W01-358-7112	AS71120	7-54
W01-358-7117	AS71170	7-54
W01-358-7123	AS71230	7-54
W01-358-7135	AS71350	7-54
W01-358-7136	AS71360	7-54
W01-358-7140	AS71400	7-55
W01-358-7145	AS71450	7-55
W01-358-7146	AS71460	7-55
W01-358-7180	AS71800	7-55
W01-358-7181	AS71810	7-55
W01-358-7183	AS71830	7-56
W01-358-7325	AS73250	7-56
W01-358-7344	AS73440	7-56
W01-358-7400	AS74000	7-56
W01-358-7401	AS74010	7-56
W01-358-7403	AS74030	7-56
W01-358-7404	AS74040	7-57
W01-358-7405	AS74050	7-57
W01-358-7406	AS74060	7-57
W01-358-7408	AS74080	7-57
W01-358-7409	AS74090	7-57
W01-358-7410	AS74100	7-57
W01-358-7423	AS74230	7-58
W01-358-7424	AS74240	7-58
W01-358-7429	AS74290	7-58
W01-358-7437	AS74370	7-58
W01-358-7443	AS74430	7-58
W01-358-7444	AS74440	7-58
W01-358-7446	AS74460	7-59
W01-358-7447	AS74470	7-59
W01-358-7472	AS74720	7-59

OEM Part No.	TRP® Part No.	Page No.
W01-358-8806	AS88060	7-75
W01-358-8810	AS88100	7-75
W01-358-8829	AS88290	7-75
W01-358-8852	AS88520	7-75
W01-358-8855	AS88550	7-75
W01-358-8856	AS88560	7-76
W01-358-8864	AS88640	7-76
W01-358-8888	AS88880	7-76
W01-358-8900	AS89000	7-76
W01-358-8901	AS89010	7-76
W01-358-8903	AS89030	7-77
W01-358-8919	AS89190	7-77
W01-358-8924	AS89240	7-77
W01-358-8927	AS89270	7-77
W01-358-8930	AS89300	7-77
W01-358-8932	AS89320	7-77
W01-358-8934	AS89340	7-78
W01-358-8944	AS89440	7-78
W01-358-8949	AS89490	7-78
W01-358-8961	AS89610	7-78
W01-358-8963	AS89630	7-78
W01-358-8964	AS89640	7-79
W01-358-8976	AS89760	7-79
W01-358-8986	AS89860	7-79
W01-358-9004	AS90040	7-79
W01-358-9008	AS90080	7-79
W01-358-9010	AS90100	7-80
W01-358-9011	AS90110	7-80
W01-358-9026	AS90260	7-80
W01-358-9029	AS90290	7-80
W01-358-9031	AS90310	7-80
W01-358-9033	AS90330	7-80
W01-358-9039	AS90390	7-81
W01-358-9053	AS90530	7-81
W01-358-9059	AS90590	7-81
W01-358-9063	AS90630	7-82
W01-358-9068	AS90680	7-82
W01-358-9069	AS90690	7-82
W01-358-9070	AS90700	7-82

OEM Part No.	TRP® Part No.	Page No.
W01-358-9071	AS90710	7-83
W01-358-9075	AS90750	7-83
W01-358-9077	AS90770	7-83
W01-358-9078	AS90780	7-83
W01-358-9082	AS90820	7-84
W01-358-9083	AS90830	7-84
W01-358-9092	AS90920	7-85
W01-358-9093	AS90930	7-85
W01-358-9096	AS90960	7-85
W01-358-9101	AS91010	7-85
W01-358-9105	AS91050	7-86
W01-358-9113	AS91130	7-86
W01-358-9116	AS91160	7-86
W01-358-9118	AS91180	7-86
W01-358-9121	AS91210	7-87
W01-358-9127	AS91270	7-87
W01-358-9134	AS91340	7-88
W01-358-9135	AS91350	7-88
W01-358-9138	AS91380	7-88
W01-358-9144	AS91440	7-88
W01-358-9148	AS91480	7-89
W01-358-9149	AS91490	7-89
W01-358-9152	AS91520	7-89
W01-358-9156	AS91560	7-89
W01-358-9164	AS91640	7-90
W01-358-9177	AS91770	7-90
W01-358-9179	AS91790	7-90
W01-358-9192	AS91920	7-90
W01-358-9193	AS91930	7-91
W01-358-9194	AS91940	7-91
W01-358-9199	AS91990	7-91
W01-358-9200	AS92000	7-91
W01-358-9203	AS92030	7-91
W01-358-9204	AS92040	7-92
W01-358-9213	AS92130	7-92
W01-358-9215	AS92150	7-92
W01-358-9216	AS92160	7-92

OEM Part No.	TRP® Part No.	Page No.
W01-358-9218	AS92180	7-92
W01-358-9219	AS92190	7-92
W01-358-9221	AS92210	7-93
W01-358-9223	AS92230	7-93
W01-358-9227	AS92270	7-93
W01-358-9228	AS92280	7-93
W01-358-9238	AS92380	7-93
W01-358-9240	AS92400	7-94
W01-358-9243	AS92430	7-94
W01-358-9245	AS92450	7-95
W01-358-9250	AS92500	7-95
W01-358-9252	AS92520	7-95
W01-358-9256	AS92560	7-95
W01-358-9265	AS92650	7-96
W01-358-9269	AS92690	7-96
W01-358-9270	AS92700	7-96
W01-358-9274	AS92740	7-96
W01-358-9275	AS92750	7-96
W01-358-9277	AS92770	7-97
W01-358-9287	AS92870	7-97
W01-358-9291	AS92910	7-97
W01-358-9293	AS92930	7-97
W01-358-9294	AS92940	7-98
W01-358-9295	AS92950	7-98
W01-358-9296	AS92960	7-98
W01-358-9297	AS92970	7-98
W01-358-9299	AS92990	7-99
W01-358-9302	AS93020	7-99
W01-358-9304	AS93040	7-99
W01-358-9307	AS93070	7-99
W01-358-9308	AS93080	7-99
W01-358-9320	AS93200	7-100
W01-358-9321	AS93210	7-100
W01-358-9325	AS93250	7-100
W01-358-9332	AS93320	7-100
W01-358-9333	AS93330	7-100
W01-358-9334	AS93340	7-101

OEM Part No.	TRP® Part No.	Page No.
W01-358-9942	AS99420	7-115
W01-358-9943	AS99430	7-116
W01-358-9944	AS99440	7-116
W01-358-9948	AS99480	7-116
W01-358-9961	AS99610	7-116
W01-358-9974	AS99740	7-117
W01-358-9501	AS95010	7-110

GOODYEAR

1B12-301	AS70090	7-52
1B12-301	AS70090	7-52
1B14-350	AS71030	7-53
1B14-350	AS71030	7-53
1B14-351	AS71050	7-53
1R10-120	AS92930	7-97
1R10-120	AS92930	7-97
1R10-122	AS92910	7-97
1R10-122	AS92910	7-97
1R11-028	AS94220	7-106
1R11-028	AS94220	7-106
1R11-150	AS94480	7-107
1R11-150	AS94480	7-107
1R11-159	AS93920	7-106
1R12-143	AS93920	7-106
1R11-166	AS92950	7-98
1R11-166	AS92950	7-98
1R11-171	AS94210	7-106
1R11-171	AS94210	7-106
1R11-178	AS93850	7-105
1R11-178	AS93850	7-105
1R11-200	AS93760	7-105
1R11-200	AS93760	7-105
1R11-201	AS93770	7-105
1R11-201	AS93770	7-105
1R11-202	AS93780	7-105
1R11-202	AS93780	7-105
1R11-203	AS93870	7-106

OEM Part No.	TRP® Part No.	Page No.
1R11-203	AS93870	7-106
1R11-205	AS94760	7-109
1R11-205	AS94760	7-109
1R11-221	AS96750	7-113
1R11-222	AS96250	7-111
1R11-242	AS96160	7-110
1R11-915	AS92940	7-98
1R11-915	AS92940	7-98
1R12-132 (15° Piston align)	AS93020	7-99
1R12-132 (15° Piston align)	AS93020	7-99
1R12-178	AS93790	7-105
1R12-178	AS93790	7-105
1R12-195	AS93490	7-102
1R12-195	AS93490	7-102
1R12-205	AS95680	7-110
1R12-256	AS93670	7-104
1R12-256	AS9367A	7-104
1R12-256	AS93670	7-104
1R12-256	AS9367A	7-104
1R12-279	AS93940	7-106
1R12-279	AS93940	7-106
1R12-303 (Plastic)	AS9780P	7-114
1R12-325	AS95670	7-110
1R12-335	AS93210	7-100
1R12-335	AS93210	7-100
1R12-357	AS93480	7-102
1R12-357	AS93480	7-102
1R12-363	AS93200	7-100
1R12-363	AS93200	7-100
1R12-365	AS94660	7-107
1R12-365	AS94660	7-107
1R12-366	AS92990	7-99
1R12-366	AS92990	7-99
1R12-367	AS96400	7-112
1R12-373	AS94910	7-109
1R12-375	AS92650	7-96
1R12-375	AS92650	7-96
1R12-400	AS92960	7-98
1R12-400	AS92960	7-98

OEM Part No.	TRP® Part No.	Page No.
1R12-401	AS93710	7-104
1R12-401	AS93710	7-104
1R12-402	AS92970	7-98
1R12-402	AS92970	7-98
1R12-403	AS93730	7-105
1R12-403	AS93730	7-105
1R12-404	AS93750	7-105
1R12-404	AS93750	7-105
1R12-424	AS92870	7-97
1R12-424	AS92870	7-97
1R12-432	ASP8890	7-118
1R12-435	AS93070	7-99
1R12-435	AS93340	7-101
1R12-435	AS93070	7-99
1R12-435	AS93340	7-101
1R12-437	AS97970	7-114
1R12-439	AS93460	7-102
1R12-439	AS93460	7-102
1R12-441	AS93620	7-103
1R12-441	AS93620	7-103
1R12-446	AS92450	7-95
1R12-446	AS92450	7-95
1R12-467	AS2467G	7-43
1R12-467	ASA8010	7-117
1R12-481	AS99230	7-115
1R12-487	AS93660	7-103
1R12-487	AS93660	7-103
1R12-498	AS99220	7-115
1R12-499	AS99360	7-115
1R12-502	AS99210	7-114
1R12-505	AS93250	7-100
1R12-505	AS93250	7-100
1R12-532	AS99350	7-115
1R12-538	AS96480	7-113
1R12-552 / 1R12-485	AS95010	7-110
1R12-560	AS93080	7-99
1R12-560	AS93080	7-99

OEM Part No.	TRP® Part No.	Page No.
1R12-561	AS93320	7-100
1R12-561	AS93320	7-100
1R12-571	AS93650	7-103
1R12-571	AS93650	7-103
1R12-580	AS93700	7-104
1R12-580	AS93700	7-104
1R12-586	AS94730	7-108
1R12-586	AS94730	7-108
1R12-603 (Aluminum)	AS9780A	7-114
1R12-620	AS93350	7-101
1R12-620	AS93350	7-101
1R12-636	AS96340	7-112
1R13-115	AS92500	7-95
1R13-115	AS92500	7-95
1R13-116	AS92520	7-95
1R13-116	AS92520	7-95
1R13-117	AS92750	7-96
1R13-117	AS92750	7-96
1R13-118	AS95800	7-110
1R13-119	AS92700	7-96
1R13-119	AS92700	7-96
1R14-170	AS55031	7-45
1R14-174	AS55030	7-45
2B12-463	AS68500	7-46
2B14-365	AS68010	7-46
2B14-366	AS68030	7-46
2B14-462	AS68050	7-46
2B14-476	AS67990	7-45
2B7-548	ASC7750	7-117
2B9-200	AS69100	7-49
2B9-201	AS69350	7-50
2B9-201	AS69350	7-50
2B9-206	AS69050	7-49
2B9-210	AS69080	7-49
2B9-218	AS69270	7-49
2B9-218	AS69270	7-49
2B9-229	AS68860	7-47
2B9-229	AS68970	7-48

OEM Part No.	TRP® Part No.	Page No.
2B9-230	AS69400	7-50
2B9-230	AS69400	7-50
2B9-239	AS69020	7-48
2B9-250	AS69430	7-50
2B9-250	AS69430	7-50
2B9-251	AS69480	7-51
2B9-251	AS69480	7-51
2B9-253	AS69450	7-51
2B9-253	AS69450	7-51
2B9-254	AS69460	7-51
2B9-254	AS69460	7-51
2B9-255	AS69470	7-51
2B9-255	AS69470	7-51
2B9-266 2B9-252	AS69440	7-50
2B9-266 2B9-252	AS69440	7-50
2B9-280	AS69410	7-50
2B9-280	AS69410	7-50
2B9-283	AS68830	7-47
2B9-288	AS69260	7-49
1R14-115	AS99610	7-116
1R13-124	AS87550	7-73

CROSS REFERENCE FOR BELLOWS

Table 7-74: Cross Reference for Bellows

OEM Part No.	Bellows No.	Page No.
FIRESTONE BELLOWS		
26	FD 110-17A	7-117
113B (was 113)	FS 530-14	7-53, 7-54
113B-1	FS 530-14	7-53, 7-54
19B (was 19)	FS 330-11	7-52
1T14C-1	6 6.5-11	7-44
1T14C-3	6 6.5-13	7-44, 7-45
1T14CB-1	6 6.5B-11	7-43, 7-117
1T15KW-(-1)	9 9-9	7-111
1T15KW-0	9 9-10	7-111, 7-113
1T15L-2	9 9-12	7-76, 7-83, 7-105, 7-106, 7-107, 7-109
1T15L-4	9 9-14	7-77, 7-105, 7-106, 7-107, 7-112
1T15L-6	9 9-16	7-111
1T15LA-(-1)	9 9-9	7-111
1T15LA-0	9 9-10	7-111
1T15LB-10	9 9B-20	7-111
1T15LC-12	9 9B-22	7-111
1T15LP-2	9 9K-12	n/a
1T15LP-5	9 9K-15	7-97, 7-98
1T15M-0	9 10-10	7-78, 7-79, 7-80, 7-81, 7-83, 7-99, 7-100, 7-101
1T15M-0.5	9 10-10.5	n/a
1T15M-11	9 10-21	7-100, 7-101, 7-104
1T15M-2	9 10-12	7-71, 7-77, 7-78, 7-81, 7-83, 7-86, 7-99, 7-100, 7-101, 7-103
1T15M-4	9 10-14	7-74, 7-75, 7-79, 7-80, 7-81, 7-82, 7-83, 7-87, 7-101, 7-107, 7-109, 7-110, 7-114
1T15M-6	9 10-16	7-75, 7-77, 7-79, 7-80, 7-84, 7-85, 7-91, 7-92, 7-93, 7-98, 7-99, 7-103, 7-106, 7-107, 7-108, 7-109, 7-112
1T15M-7.5	9 10-17.5	7-45, 7-76, 7-77, 7-78, 7-102, 7-108
1T15M-8	9 10-18.5	7-97, 7-98, 7-104, 7-105, 7-113
1T15M-9	9 10-19	7-43, 7-75, 7-76, 7-90, 7-91, 7-93, 7-94, 7-95, 7-96, 7-102, 7-103, 7-106

OEM Part No.	Bellows No.	Page No.
1T15MBTW-10	9 10BP-20	7-113
1T15MBTW-6	9 10BP-16	7-112
1T15MBTW-12	9 10BP-22	7-112
1T15V-11	9 10D-21	7-95, 7-96
1T15V-8	9 10B-17.5	7-96, 7-109
1T15VP-4	9 10-13.5	7-96, 7-118
1T15ZR-6	9 10S-16	7-114
1T17B-11	10 10-21	7-72, 7-110
1T17B-5	10 10-15	7-71, 7-72, 7-73, 7-74
1T17CA-5	10 10.5-15	7-71
1T17CA-6.5	10 10-16	7-71, 7-72
1T19F-11	11 10.5-21	7-73, 7-87, 7-89, 7-90, 7-91
1T19F-12	11 10.5-22	7-45
1T19F-5	11 10.5-15	7-70, 7-91, 7-92, 7-97
1T19F-7	11 10.5-17	7-86, 7-87, 7-88, 7-89, 7-90, 7-93
1T19F-9	11 10.5-19	7-73, 7-74, 7-88
1T19FC-6	11 10.5A-16	7-70
1T19FC-8m	11 10.5B-18	n/a
1T19L-11	11 10.5-21	7-73, 7-87, 7-89, 7-90, 7-91
1T19L-12	11 10.5-22	7-45
1T19L-5	11 10.5-15	7-70, 7-91, 7-92, 7-97
1T19L-7	11 10.5-17	7-86, 7-87, 7-88, 7-89, 7-90, 7-93
1T19LC-6	11 10.5A-16	7-70
1T19LC-8	11 10.5B-18	n/a
1T19LF-7	11 10.5F-17	n/a
1T19ZK-5.7 (was 1T19J-6)	11 10.5C-16	7-69, 7-70
20F (was 20)	FD 200-19	7-47, 7-48, 7-49, 7-50, 7-60, 7-61, 7-62
20F-1 (was 20-1)	FD 200-22	7-47, 7-66
20F-2 (was 20-2)	FD 200-25	7-49, 7-50, 7-51, 7-52
21D (was 21)	FD 530-22	7-54, , 7-55
224C	FD 110-15	n/a
228C-1.5 (was 228-1.5)	FD 331-26	7-60
22C (was 22)	FD 330-22	7-46, 7-55, 7-56, 7-57, 7-58
22C-1.5 (was 22-1.5)	FD 330-30	7-45, 7-58, 7-59, 7-61
233D-2 (was 233-2)	FD 530-35	7-45, 7-60, 7-61
255C1.5	FD 70-15	n/a
26C (was 26)	FD 120-20	7-56, 7-61

OEM Part No.	Bellows No.	Page No.
313D (was 313)	FT 530-32	7-62, 7-63
333C (was 333)	FT 530-35	7-63, 7-64, 7-65, 7-66
38D (was 38)	FT 330-29	7-66, 7-67, 7-68, 7-69
GOODYEAR BELLOWS		
556-33-8-335	FT 530-35	7-63, 7-64, 7-65, 7-66
566-18-3-003	6 6.5-11	7-44
566-18-3-003	6 6.5B-11	7-43
566-18-3-010	6 6.5-13	7-44, 7-45
566-22-3-006	9 9-14	7-77, 7-105, 7-106, 7-107, 7-112
566-22-3-021	9 9-9	7-111
566-22-3-021	9 9-10	7-111, 7-113
566-22-3-021	9 9-12	7-76, 7-83, 7-105, 7-106, 7-107, 7-109, 7-110
566-22-3-143	9 9K-15	7-97, 7-98
566-24-3-038	9 10-16	7-75, 7-77, 7-79, 7-80, 7-84, 7-85, 7-91, 7-92, 7-93, 7-98, 7-99, 7-103, 7-106, 7-107, 7-108, 7-109
566-24-3-066	9 10-19	7-43, 7-75, 7-76, 7-90, 7-91, 7-93, 7-94, 7-95, 7-96, 7-102, 7-103, 7-106
566-24-3-067	9 10-10	7-78, 7-79, 7-80, 7-81, 7-83, 7-99, 7-100, 7-101
566-24-3-067	9 10-12	7-71, 7-77, 7-78, 7-81, 7-83, 7-86, 7-99, 7-100, 7-101, 7-103, 7-112, 7-117
566-24-3-076	9 10-14	7-74, 7-75, 7-79, 7-80, 7-81, 7-82, 7-83, 7-87, 7-101, 7-107, 7-109, 7-110
566-24-3-090	9 10-21	7-100, 7-101, 7-104
566-24-3-097	9 10-17.5	7-45, 7-76, 7-77, 7-78, 7-102, 7-108
566-24-3-097	9 10-18.5	7-97, 7-98, 7-104, 7-105
566-24-3-108	9 10S-16	7-114
566-26-3-043	9 10B-17.5	7-96, 7-109
566-26-3-044	9 10D-21	7-95, 7-96
566-26-3-050	10 10-15	7-71, 7-72, 7-73, 7-74
566-26-3-053	9 10-13.5	7-96, 7-118
566-26-3-071	10 10-21	7-72, 7-110
566-26-3-073	10 10.5-15	7-71
566-26-3-078	10 10-16	7-71, 7-72
566-28-3-015	11 10.5-15	7-70, 7-91, 7-92, 7-97
566-28-3-015	11 10.5A-16	7-70

OEM Part No.	Bellows No.	Page No.
566-28-3-015	11 10.5C-16	7-69, 7-70
566-28-3-020	11 10.5-21	7-73, 7-87, 7-89, 7-90, 7-91
566-28-3-021	11 10.5-17	7-86, 7-87, 7-88, 7-89, 7-90, 7-93
566-28-3-021	11 10.5-19	7-73, 7-74, 7-88
566-28-3-030	11 10.5-22	7-45
566-28-3-042	11 10.5F-17	n/a
578-91-3-301	FS 330-11	7-52
578-91-3-310	FD 330-30	7-45, 7-58, 7-59, 7-61
578-91-3-351	FS 530-14	7-53, 7-54
578-91-3-352	FS 530-14	7-53, 7-54
578-92-3-202	FD 200-19	7-47, 7-48, 7-49, 7-50, 7-60, 7-61, 7-62
578-92-3-206	FD 200-25	7-49, 7-50, 7-51, 7-52
578-92-3-309	FD 330-22	7-46, 7-55, 7-56, 7-57, 7-58
578-92-3-315	FD 331-26	7-60
578-92-3-353	FD 530-22	7-54, , 7-55
578-92-3-356	FD 530-35	7-45, 7-60, 7-61
578-93-3-100	FT 330-29	7-66, 7-67, 7-68, 7-69
578-93-3-350	FT 530-32	7-62, 7-63
579-92-3-515	FD 110-15	n/a
579-92-3-526	FD 110-17A	7-117
579-92-3-530	FD 120-20	7-56, 7-61



SHOCKS



3 Settings: Regular / Firm / Extra Firm

FEATURES & BENEFITS

- » Three settings for personal ride selection
- » High temperature shock fluid for long life
- » Big bore power absorbs more road shock
- » Exclusive nine-stage valving provides more control at all speeds
- » Unique energy absorbing hydraulic rebound stop reduces damage to mounts

RECOMMENDATIONS

When purchasing new tires, the customer should also look at the shocks to see if they are worn or have excessive mileage. Worn shocks can be a contributor to excessive tire wear.

GAS SHOCKS

TRP® Gas Shocks are built to withstand demanding operating conditions, while providing a “like-new” truck ride. TRP® Gas Shocks are adjustable with three settings: Regular, Firm and Extra Firm.

Gas cell technology eliminates aeration or foaming of oil for more consistent damping performance, regardless of the terrain or road conditions. TRP® Gas Shocks are engineered for long life with high-temperature shock fluid and 360-degree reinforced arc-welded end mounts.

Scan the code for more information.
Get the free mobile app at <http://gettag.mobi>



SHOCK APPLICATION & MODEL INFORMATION

ACF BRILL BUS

Table 7-75: Suspension & Ride Control - Shock Application: ACF Brill Bus

Part No.	Front/Rear	Application & Model Information	OEM Part No.
89422GSK	Front/Rear	Additional OEM Interchanges	631237
89422GSK	Front/Rear	Additional OEM Interchanges	641521
89422GSK	Front/Rear	Additional OEM Interchanges	649648
89422GSK	Front/Rear	Additional OEM Interchanges	659129

ALLCO TRAILER

Table 7-76: Suspension & Ride Control - Shock Application: Allco Trailer

Part No.	Front/Rear	Application & Model Information	OEM Part No.
89406GSK	Rear	Dump Trailers w/ Watson & Chalin TA-5000-DB-19 Air Suspension	727602

AM GENERAL

Table 7-77: Suspension & Ride Control - Shock Application: AM General

Part No.	Front/Rear	Application & Model Information	OEM Part No.
89420GSK	Rear	Small Bus	5979484

ARVIN MERITOR

Table 7-78: Suspension & Ride Control - Shock Application: ARVIN MERITOR

Part No.	Front/Rear	Application & Model Information	OEM Part No.
89436GSK	Rear	Models w/ OEM Number	654907

BENSON TRUCK BODIES INC.

Table 7-79: Suspension & Ride Control - Shock Application: BENSON TRUCK BODIES INC.

Part No.	Front/Rear	Application & Model Information	OEM Part No.
89407GSK	Rear	Models w/ Neway Air Suspension	90044089
89436GSK	Rear	Models w/ Hendrickson Intraax Air Suspension	A-20002

BLUE BIRD

Table 7-80: Suspension & Ride Control - Shock Application: Blue Bird

Part No.	Front/Rear	Application & Model Information	OEM Part No.
89402GSK	Front/Rear	Additional OEM Interchanges	70317
89407GSK	Front/Rear	Additional OEM Interchanges	1962430
89413GSK	Front/Rear	School Bus w/ 3/4" Mounting Pins	2021459
89414GSK	Rear	Buses w/ Reyco Air Suspension	1668730
89414GSK	Rear	Buses w/ Reyco Air Suspension	1722222
89430GSK	Rear	All American Buses (FE & RE Models) - w/ 19,000 lb - 21,000 lb 2-Stage Leaf Springs	AMS65110
89432GSK	Rear	All American Buses (FE & RE Models) - Front Suspension	AMS65109
89440GSK	Front	Buses w/ Reyco Air Suspension	1668722
89440GSK	Rear	WanderLodge - w/ Reyco Air Suspension	1722214

BROCKWAY SCHOOL BUS

Table 7-81: Suspension & Ride Control - Shock Application: BROCKWAY SCHOOL BUS

Part No.	Front/Rear	Application & Model Information	OEM Part No.
89407GSK	Front	Models w/ OEM Number	530873
89422GSK	Front	Models w/ OEM Number	515231

BUS & TRUCK Co.

Table 7-82: Suspension & Ride Control - Shock Application: BUS & TRUCK CO.

Part No.	Front/Rear	Application & Model Information	OEM Part No.
89422GSK	Front/Rear	Silver Eagle Bus	680091
89422GSK	Front/Rear	Silver Eagle Bus	70039

CHALMERS SUSPENSION

Table 7-83: Suspension & Ride Control - Shock Application: CHALMERS SUSPENSION

Part No.	Front/Rear	Application & Model Information	OEM Part No.
89425GSK	Rear	Models w/ OEM Number	800781

CHANCE BUS

Table 7-84: Shock Application: Chance Bus

Part No.	Front/Rear	Application & Model Information	OEM Part No.
89407GSK	Front/Rear	Models w/ OEM Number	59039
89407GSK	Front/Rear	Models w/ OEM Number	6892
89436GSK	Front	Models w/ OEM Number	6893
89436GSK	Front/Rear	Models w/ OEM Number	728600

CHEVROLET TRUCK

Table 7-85: Suspension & Ride Control - Shock Application: CHEVROLET TRUCK

Part No.	Front/Rear	Application & Model Information	OEM Part No.
89406GSK	Rear	1999 - T - Series (T5500, T6500, T7500, T8500) - Models w/ Hendrickson Air Suspension (Stamping number 47902-13)	12474915
89406GSK	Rear	1999 - T - Series (T5500, T6500, T7500, T8500) - Models w/ Hendrickson Air Suspension (Stamping number 47902-13)	15963161
89406GSK	Rear	1995 - 1999 - C - Series (C6500, C7500, C8500) Kodiak - Models w/ Hendrickson Air Suspension (Stamping number 47902-13)	12474915
89406GSK	Rear	1995 - 1999 - C - Series (C6500, C7500, C8500) Kodiak - Models w/ Hendrickson Air Suspension (Stamping number 47902-13)	15963161
89407GSK	Front/Rear	Additional OEM Interchanges	4940650
89407GSK	Front/Rear	Additional OEM Interchanges	4940660
89407GSK	Front/Rear	Additional OEM Interchanges	5532425
89407GSK	Front/Rear	Additional OEM Interchanges	5532433
89407GSK	Front/Rear	Additional OEM Interchanges	5549899
89407GSK	Front	1973 - 1975 - 6, 60, 6000 & 6500 Series - C, M, S Chassis - Conventional Cab and School Bus w/ 5,000/7,000 lb Axles	22007750
89407GSK	Front	1973 - 1975 - 6, 60, 6000 & 6500 Series - C, M, S Chassis - Conventional Cab and School Bus w/ 5,000/7,000 lb Axles	4975467
89407GSK	Front	1973 - 1975 - 6, 60, 6000 & 6500 Series - C, M, S Chassis - Conventional Cab and School Bus w/ 5,000/7,000 lb Axles	4975494
89407GSK	Front	1973 - 1975 - 6, 60, 6000 & 6500 Series - SE, SS-60 thru Serial # 134487 (1975 1st Design)	22007700
89407GSK	Front	1973 - 1975 - 6, 60, 6000 & 6500 Series - SE, SS-60 thru Serial # 134487 (1975 1st Design)	22007750
89407GSK	Front	1973 - 1975 - 6, 60, 6000 & 6500 Series - SE, SS-60 thru Serial # 134487 (1975 1st Design)	4975467
89407GSK	Front	1973 - 1975 - 6, 60, 6000 & 6500 Series - SE, SS-60 thru Serial # 134487 (1975 1st Design)	4975494
89407GSK	Front	1973 - 1980 - 5, 50, 5000 & 5500 Series - C, M, S Chassis - Conventional Cab	22007750
89407GSK	Front	1973 - 1980 - 5, 50, 5000 & 5500 Series - C, M, S Chassis - Conventional Cab	4975467
89407GSK	Front	1973 - 1980 - 5, 50, 5000 & 5500 Series - C, M, S Chassis - Conventional Cab	4975494

Part No.	Front/Rear	Application & Model Information	OEM Part No.
89413GSK	Rear	1983 - 1995 - W - Series (Isuzu) - W4 Series	9-51630-666-0
89413GSK	Rear	1983 - 1995 - W - Series (Isuzu) - W4 Series	9-51630-666-2
89413GSK	Rear	1989 - 1992 - W - Series (Isuzu) - W4 Series Flatlow	9-51630-666-0
89413GSK	Rear	1989 - 1992 - W - Series (Isuzu) - W4 Series Flatlow	9-51630-666-2
89414GSK	Front/Rear	Additional OEM Interchanges	684280
89414GSK	Rear	1966 - 1972 - 7, 70 & 7000 Series - 72" BBC Steel Tilt Cab w/ V-6, 2-Cycle Diesel Engine w/ 19101 and 19201 Axle	4940600
89419GSK	Front/Rear	Additional OEM Interchanges	3188626
89419GSK	Front/Rear	Additional OEM Interchanges	4975429
89419GSK	Front/Rear	Additional OEM Interchanges	5357955
89419GSK	Front/Rear	Additional OEM Interchanges	5357959
89419GSK	Front/Rear	Additional OEM Interchanges	5527001
89420GSK	Front/Rear	Additional OEM Interchanges	5544581
89420GSK	Front/Rear	Additional OEM Interchanges	5554184
89420GSK	Front/Rear	Additional OEM Interchanges	5554814
89420GSK	Front	1966 - 1969 - 8, 80 & 8000 Series - 72" BBC Steel Tilt Cab	5544060
89422GSK	Front/Rear	Additional OEM Interchanges	4939852
89422GSK	Front/Rear	Additional OEM Interchanges	4939967
89422GSK	Front/Rear	Additional OEM Interchanges	5374779
89422GSK	Front/Rear	Additional OEM Interchanges	5522794
89422GSK	Front/Rear	Additional OEM Interchanges	5552210
89422GSK	Front/Rear	Additional OEM Interchanges	5552244
89422GSK	Front/Rear	Additional OEM Interchanges	3172948
89422GSK	Front/Rear	Additional OEM Interchanges	3188729
89422GSK	Front/Rear	Additional OEM Interchanges	5353054
89422GSK	Front/Rear	Additional OEM Interchanges	5392387
89422GSK	Front/Rear	Additional OEM Interchanges	5534430
89422GSK	Front/Rear	Additional OEM Interchanges	5534447
89422GSK	Front/Rear	Additional OEM Interchanges	5554596
89422GSK		Models w/ OEM Number	22046489
89422GSK	Front	1970 - 1980 - 8, 80 & 8000 Series - T, W Chassis - 72" BBC Steel Tilt Cab w/ V-6 Gas Engine	22012091
89422GSK	Front	1970 - 1980 - 8, 80 & 8000 Series - T, W Chassis - 72" BBC Steel Tilt Cab w/ V-6 Gas Engine	5552452
89422GSK	Front	1970 - 1980 - 9000 Series - T, W Chassis - 72" BBC Steel Tilt Cab	22012091
89422GSK	Front	1970 - 1980 - 9000 Series - T, W Chassis - 72" BBC Steel Tilt Cab	5552452

Part No.	Front/Rear	Application & Model Information	OEM Part No.
89422GSK	Front	1973 - 1980 - 7, 70 & 7000 Series - R Chassis - Rear Engine Bus	22012090
89422GSK	Front	1973 - 1980 - 7, 70 & 7000 Series - R Chassis - Rear Engine Bus	5552451
89422GSK	Rear	1973 - 1980 - 7, 70 & 7000 Series - R Chassis - Rear Engine Bus	5552552
89422GSK	Front	1973 - 1980 - 7, 70 & 7000 Series - T, W Chassis - 72" BBC Steel Tilt Cab w/ V-6 Gas Engine	22012091
89422GSK	Front	1973 - 1980 - 7, 70 & 7000 Series - T, W Chassis - 72" BBC Steel Tilt Cab w/ V-6 Gas Engine	5552452
89422GSK	Front	1973 - 1980 - 8, 80 & 8000 Series - R Chassis - Rear Engine Bus	22012090
89422GSK	Front	1973 - 1980 - 8, 80 & 8000 Series - R Chassis - Rear Engine Bus	5552451
89422GSK	Rear	1973 - 1980 - 8, 80 & 8000 Series - R Chassis - Rear Engine Bus	22012091
89422GSK	Front	1973 - 1980 - 8, 80 & 8000 Series - R Chassis - Rear Engine Bus	5552452
89430GSK	Rear	1966 - 1972 - 7, 70 & 7000 Series - 72" BBC Steel Tilt Cab w/ V-6, 2-Cycle Diesel Engine	22012095
89430GSK	Rear	1967 - 1972 - 7, 70 & 7000 Series - 72" BBC Steel Tilt Cab w/ V-6, 2-Cycle Diesel Engine	3171462
89430GSK	Rear	1968 - 1972 - 7, 70 & 7000 Series - 72" BBC Steel Tilt Cab w/ V-6, 2-Cycle Diesel Engine	3192890
89430GSK	Rear	1968 - 1969 - 6, 60, 6000 & 6500 Series - All w/ 9000 & 11000 lb Axles - Excluding Tilt Cab	22012095
89430GSK	Front	1968 - 1969 - 6, 60, 6000 & 6500 Series - All w/ 9000 & 11000 lb Axles - Excluding Tilt Cab	4940606
89430GSK	Front	1969 - 1970 - 4, 40, 4000 & 4500 Series - D-D Forward Control w/ Tilt Cab	22012095
89430GSK	Front	1969 - 1970 - 4, 40, 4000 & 4500 Series - D-D Forward Control w/ Tilt Cab	4940606
89430GSK	Front	1969 - 1970 - 5, 50, 5000 & 5500 Series - D-D Forward Control w/ Tilt Cab	22012095
89430GSK	Front	1969 - 1970 - 5, 50, 5000 & 5500 Series - D-D Forward Control w/ Tilt Cab	4940606
89430GSK	Rear	1971 - 1972 - 5, 50, 5000 & 5500 Series - TDM 4-Cycle Detroit Diesel w/ Tandem Axle - Excluding Tilt Cab	22012095

Part No.	Front/Rear	Application & Model Information	OEM Part No.
89430GSK	Front	1971 - 1972 - 5, 50, 5000 & 5500 Series - TDM 4-Cycle Detroit Diesel w/ Tandem Axle - Excluding Tilt Cab	4940606
89430GSK	Rear	1971 - 1972 - 6, 60, 6000 & 6500 Series - Conventional Cab & Tilt Cab w/ 9,000/ 11,000 lb Axles	22012095
89430GSK	Front	1971 - 1972 - 6, 60, 6000 & 6500 Series - Conventional Cab & Tilt Cab w/ 9,000/ 11,000 lb Axles	4940606
89430GSK	Rear	1971 - 1972 - 6, 60, 6000 & 6500 Series - TDM 4-Cycle Detroit Diesel w/ Tandem Axle	22012095
89430GSK	Front	1971 - 1972 - 6, 60, 6000 & 6500 Series - TDM 4-Cycle Detroit Diesel w/ Tandem Axle	4940606
89430GSK	Rear	1973 - 1974 - 6, 60, 6000 & 6500 Series - SG, SM-60	3192890
89430GSK	Front	1973 - 1974 - 6, 60, 6000 & 6500 Series - SG, SM-61	4940606
89430GSK	Front	1973 - 1974 - 6, 60, 6000 & 6500 Series - SG, SM-62	22002293
89430GSK	Front	1973 - 1974 - 6, 60, 6000 & 6500 Series - SG, SM-63	22007701
89430GSK	Rear	1973 - 1978 - 5, 50, 5000 & 5500 Series - S-50 School Bus	22012166
89430GSK	Front	1973 - 1978 - 6, 60, 6000 & 6500 Series - S-60 w/ Air Brakes	22007701
89430GSK	Front	1974 - 1978 - 6, 60, 6000 & 6500 Series - S-60 w/ Air Brakes	22012095
89430GSK	Rear	1975 - 1978 - 6, 60, 6000 & 6500 Series - S-60 w/ Air Brakes	22012166
89430GSK	Front	1976 - 1978 - 6, 60, 6000 & 6500 Series - S-60 w/ Air Brakes	4940606
89430GSK	Front	1973 - 1980 - 6, 60, 6000 & 6500 Series - C, S, T Chassis - Conventional & Tilt Cab and School Bus w/ 5,000/ 7,000 lb Axles	22002293
89430GSK	Front	1973 - 1980 - 6, 60, 6000 & 6500 Series - C, S, T Chassis - Conventional & Tilt Cab and School Bus w/ 5,000/ 7,000 lb Axles	22007701
89430GSK	Front	1973 - 1980 - 6, 60, 6000 & 6500 Series - C, S, T Chassis - Conventional & Tilt Cab and School Bus w/ 5,000/ 7,000 lb Axles	22012095
89430GSK	Front	1973 - 1980 - 6, 60, 6000 & 6500 Series - C, S, T Chassis - Conventional & Tilt Cab and School Bus w/ 5,000/ 7,000 lb Axles	3192890
89430GSK	Front	1973 - 1980 - 6, 60, 6000 & 6500 Series - C, S, T Chassis - Conventional & Tilt Cab and School Bus w/ 5,000/ 7,000 lb Axles	4940606
89430GSK	Front	1973 - 1980 - 6, 60, 6000 & 6500 Series - C, S, T Chassis - Conventional & Tilt Cab and School Bus w/ 5,000/ 7,000 lb Axles	4940662

Part No.	Front/Rear	Application & Model Information	OEM Part No.
89430GSK	Front	1973 - 1980 - 6, 60, 6000 & 6500 Series - C, S, T Chassis - Conventional & Tilt Cab and School Bus w/ 5,000/ 7,000 lb Axles	4975497
89430GSK	Rear	1973 - 1980 - 7, 70 & 7000 Series - T, W Chassis - 72" BBC Steel Tilt Cab (4 x 2) w/ V-6 Diesel Engine	22012095
89430GSK	Front	1973 - 1980 - 7, 70 & 7000 Series - T, W Chassis - 72" BBC Steel Tilt Cab (4 x 2) w/ V-6 Diesel Engine	4940606
89430GSK	Front	1973 - 1980 - 7, 70 & 7000 Series - T, W Chassis - 72" BBC Steel Tilt Cab (4 x 2) w/ V-6 Diesel Engine	4975497
89430GSK	Rear	1973 - 1989 - 5, 50, 5000 & 5500 Series - C, S Chassis - Conventional Cab and School Bus	22012095
89430GSK	Rear	1973 - 1989 - 5, 50, 5000 & 5500 Series - C, S Chassis - Conventional Cab and School Bus	22012166
89430GSK	Rear	1973 - 1989 - 6, 60, 6000 & 6500 Series - C, S Chassis - Conventional Cab and School Bus w/ 20,800/ 23,000 lb Rear Axles	22012095
89430GSK	Rear	1973 - 1989 - 6, 60, 6000 & 6500 Series - C, S Chassis - Conventional Cab and School Bus w/ 20,800/ 23,000 lb Rear Axles	22012166
89430GSK	Front	1973 - 1989 - 6, 60, 6000 & 6500 Series - C, S Chassis - Conventional Cab and School Bus w/ 20,800/ 23,000 lb Rear Axles	4940606
89430GSK	Front	1979 - 1980 - 6, 60, 6000 & 6500 Series - W Chassis - 72" BBC Steel Tilt Cab	22002293
89430GSK	Rear	1979 - 1989 - 6, 60, 6000 & 6500 Series - B6P042 School Bus w/ 18,500/ 20,800 lb Rear Springs	22012095
89430GSK	Front	1979 - 1989 - 6, 60, 6000 & 6500 Series - B6P042 School Bus w/ 18,500/ 20,800 lb Rear Springs	22012166
89430GSK	Rear	1979 - 1989 - 7, 70 & 7000 Series - C, M Chassis - 97" BBC Conventional Cab	22012095
89430GSK	Front	1979 - 1989 - 7, 70 & 7000 Series - C, M Chassis - 97" BBC Conventional Cab	22012166
89430GSK	Rear	1983 - 1984 - 7, 70 & 7000 Series - S7T042 Forward Control Chassis w/ 17,000/ 18,500/ 21,000/ 23,000 lb Rear Axles	22012095
89430GSK	Front	1983 - 1984 - 7, 70 & 7000 Series - S7T042 Forward Control Chassis w/ 17,000/ 18,500/ 21,000/ 23,000 lb Rear Axles	22012166
89436GSK	Front/Rear	Additional OEM Interchanges	4940627
89436GSK	Front/Rear	Additional OEM Interchanges	5348631
89436GSK	Front/Rear	Additional OEM Interchanges	5559363

Part No.	Front/Rear	Application & Model Information	OEM Part No.
89440GSK		Models w/ OEM Number	22065251

CONTINENTAL TRAILWAYS-EAGLE INTERNATIONAL

Table 7-86: Suspension & Ride Control - Shock Application: Continental Trailways-Eagle International

Part No.	Front/Rear	Application & Model Information	OEM Part No.
89422GSK	Front/Rear	Silver Eagle	01-0100-905
89422GSK	Front/Rear	Silver Eagle	680091
89422GSK	Front/Rear	Silver Eagle	70039

CROWN CARRIER

Table 7-87: Suspension & Ride Control - Shock Application: Crown Carrier

Part No.	Front/Rear	Application & Model Information	OEM Part No.
89422GSK	Front	Models w/ OEM Number	277A-8
89422GSK	Front/Rear	Models w/ OEM Number	680091
89420GSK	Front	Models w/ OEM Number	277A-13

CROWN COACH

Table 7-88: Suspension & Ride Control - Shock Application: Crown Coach

Part No.	Front/Rear	Application & Model Information	OEM Part No.
89422GSK	Front/Rear	All w/ Steel Spring Suspension	3188729

DURA SUSPENSION

Table 7-89: Suspension & Ride Control - Shock Application: Dura Suspension

Part No.	Front/Rear	Application & Model Information	OEM Part No.
89407GSK	Rear	Models w/ OEM Number	12866
89436GSK	Rear	Models w/ OEM Number	1080099
89436GSK	Rear	Models w/ OEM Number	59030
89436GSK	Rear	Models w/ OEM Number	665133

EAGLE MOTOR COACH

Table 7-90: Suspension & Ride Control - Shock Application: Eagle Motor Coach

Part No.	Front/Rear	Application & Model Information	OEM Part No.
89422GSK	Front	Additional OEM Interchanges	014-0100-905
89425GSK	Front	Models w/ OEM Number	154-0100-514
89422GSK	Front	Models w/ OEM Number	014-0100-905
89422GSK	Front/Rear	Models w/ OEM Number	01-0100-905
89422GSK	Front/Rear	Models w/ OEM Number	3
89422GSK	Front/Rear	Models w/ OEM Number	70039

EAST MANUFACTURING CORP.

Table 7-91: Shock Application: East Manufacturing Corp.

Part No.	Front/Rear	Application & Model Information	OEM Part No.
89440GSK	Rear	Trailers w/ East Trailer part number	517-05006-20
89430GSK	Rear	Trailers w/ East Trailer part number	517-05001-23
89436GSK	Rear	Trailers w/ East Trailer part number	517-05110-20
89436GSK	Rear	Trailers w/ East Trailer part number	517-05805-20
89407GSK	Rear	Trailers w/ East Trailer part number	517-05916-14
89437GSK	Rear	Trailers w/ East Trailer part number	517-05809-20

FLXIBLE BUS

Table 7-92: Suspension & Ride Control - Shock Application: FLXIBLE BUS

Part No.	Front/Rear	Application & Model Information	OEM Part No.
89447GSK	n/a	Additional OEM Interchanges	97-2210-00160
89424GSK	n/a	Additional OEM Interchanges	97-9999-02633

FORD

Table 7-93: Suspension & Ride Control - Shock Application: Ford

Part No.	Front/Rear	Application & Model Information	OEM Part No.
89401GSK	Front	Models w/ OEM Number	57365-111
89401GSK	Front	Models w/ OEM Number	70127
89401GSK	Front	Models w/ OEM Number	70128
89401GSK	Front	Models w/ OEM Number	F0HS-18045-AA
89401GSK	Front	1990 - LL, LLA, LTA, LTL, LTLA - Conventional Cab - LLA-9000, LTLA-9000 w/ 4500, 5400, 6500 lb 58" Parabolic Taper-Leaf Spring	F0HT-18045-CA
89401GSK	Front	1990 - LN & LNT - Conventional Cab - LN-7000, LN-8000, LN-9000, LNT-8000, LNT-9000 w/ 52" Taper-Leaf Spring	F1HT-18045-GA
89401GSK	Front	1990 - 1997 - L, LT & LTS - Conventional Cab - L-8000, L-9000, LT-8000, LT-9000 w/ 52" Taper-Leaf Spring	F1HT-18045-GA
89401GSK	Front	1991 - 1996 - LL, LLA, LTA, LTL, LTLA - Conventional Cab - LLA-9000, LTLA-9000 w/ 4,500/ 5,400/ 6,500 lb 58" Parabolic Taper-Leaf Spring	F1HT-18045-HB
89401GSK	Front	Models w/ OEM Number	F1HT-18045-LB
89401GSK	Front	Models w/ OEM Number	F1HZ-18124-D
89401GSK	Front	Models w/ OEM Number	F1HZ-18124-E
89401GSK	Front	Models w/ OEM Number	F1HZ-18124-F
89401GSK	Front	Models w/ OEM Number	F1HZ-18124-G
89401GSK	Front	Models w/ OEM Number	F6HT-18045-MA
89401GSK	Front	Models w/ OEM Number	F6HZ-18124-MA
89402GSK	Rear	1996 - 1997 - All w/ Neway AD-123 Air Suspension - Rear Suspension - AeroMax (A, AT, AAT, 8500, 9500) Series	90045068
89402GSK	Front	1990 - 1997 - LA, LS & LST - Conventional Cab - Front Suspension - LA-8000, LS-8000, LST-8000 w/ 52" Taper-Leaf Spring	F1HT-18045-EA

Part No.	Front/ Rear	Application & Model Information	OEM Part No.
89402GSK	Front	1991 - 1996 - LA, LS & LST - Conventional Cab - LA-8000, LS-8000, LST-8000 w/ 58" Taper-Leaf Spring	F1HT-18045-EB
89402GSK	Front	1990 - LN & LNT - Conventional Cab - Front Suspension - LN-7000, LN-8000, LN-9000, LNT-8000, LNT-9000 w/ 58" Parabolic Taper-Leaf Spring	F1HT-18045-RA
89402GSK	Front	1990 - 1997 - LN & LNT - Conventional Cab - Front Suspension - LN-7000, LN-8000, LN-9000, LNT-8000, LNT-9000 w/ 58" Parabolic Taper-Leaf Spring	F1HT-18045-RA
89402GSK	Front	1990 - 1997 - L, LT & LTS - Conventional Cab - Front Suspension - L-8000, L-9000, LT-8000, LT-9000 w/ 58" Parabolic Taper-Leaf Spring	F1HT-18045-RB
89402GSK	Front	1990 - 1997 - LN & LNT - Conventional Cab - Front Suspension - LN-7000, LN-8000, LN-9000, LNT-8000, LNT-9000 w/ 58" Parabolic Taper-Leaf Spring	F1HT-18045-RB
89402GSK	Front	Other Applications - Front Suspension - Models w/ OEM Number	F1HT-18045-RB
89402GSK	Front	Other Applications - Front Suspension - Models w/ OEM Number	F1HZ-18124-C
89402GSK	Front	Other Applications - Front Suspension - Models w/ OEM Number	F1HZ-18124-K
89402GSK	Rear	1996 - 1997 - All w/ Neway AD-123 Air Suspension - Rear Suspension - AeroMax (A, AT, AAT, 8500, 9500) Series	F6HZ-18125-C
89405GSK	Rear	1978 - 1989 - CL & CLT Series - Highway Tractor Tilt Cab - CL-9000, CLT-9000 w/ Rear Tandem Axle w/ Neway Suspension	D7HA-18080-AA
89405GSK	n/a	Additional OEM Interchanges	D7HT-18125-FA
89405GSK	Rear	Models w/ OEM Number	D8HZ-18125-B
89406GSK	Rear	CL & CLT Series - Highway Tractor Tilt Cab - Models w/ Hendrickson Rear Air Suspension	47902-13
89406GSK	Rear	L, LT & LTS - Conventional Cab - L-8000, L-9000, LT-8000, LT-9000 w/ Hendrickson Rear Air Suspension	47902-13
89406GSK	Rear	LN & LNT - Conventional Cab - LN-7000, LN-8000, LN-9000, LNT-8000, LNT-9000 w/ Hendrickson Rear Air Suspension	47902-13
89406GSK	n/a	Additional OEM Interchanges	47902-8
89407GSK	Rear	Models w/ OEM Number	90044769
89407GSK	Rear	Models w/ OEM Number	90044770
89409GSK	n/a	Additional OEM Interchanges	B8QZ-18124-A
89409GSK	Front	1964 - 1969 - F Series - Conventional Cab - F-800, F-850, F-900, F-950, F-1000 w/ 6,000/ 7,000/ 9,000/ 11,000/ 12,000/ 15,000/ 18,000 lb Axles (Excluding Diesel w/ 6,000 and 7,000 lb Axles)	C1TT-18045-C
89409GSK	Front	1964 - 1969 - N and NT 89" BBC Conventional Cab - N-800, N-850, N-900, N-950 - Excluding Diesel w/ 6,000/ 7,000 lb Axles	C1TT-18045-C
89409GSK	Front	1967 - 1969 - N and NT 89" BBC Conventional Cab - N-750 w/ 9,000 lb Axle	C1TT-18045-C

Part No.	Front/ Rear	Application & Model Information	OEM Part No.
89409GSK	Front	1967 - 1969 - N and NT 89" BBC Conventional Cab - N-850, N-900, N-950 w/ 6,000/ 7,000/ 9,000/ 11,000/ 12,000 lb Axles	C1TT-18045-C
89409GSK	Front	1970 - 1975 - LN & LNT - Conventional Cab - LN-700, LN-750 Diesel w/ 9,000 lb Axle	C1TT-18045-C
89409GSK	Front	Additional OEM Interchanges	C1TZ-18045-C
89409GSK	n/a	Additional OEM Interchanges	C1TZ-18124-C
89409GSK	n/a	Additional OEM Interchanges	C4HZ-18124-A
89409GSK	n/a	Additional OEM Interchanges	C4HZ-18124-D
89409GSK	Front	1964 - 1967 - N and NT 89" BBC Conventional Cab - N-600, N-650, N-700, N-750 w/ 6,000/ 7,000 lb Axles	C6PF-18077-DL
89409GSK	Front	1964 - 1969 - F Series - Conventional Cab - F-800, F-850, F-900, F-950, F-1000 w/ 6,000/ 7,000/ 9,000/ 11,000/ 12,000/ 15,000/ 18,000 lb Axles (Excluding Diesel w/ 6,000 and 7,000 lb Axles)	C6PF-18077-DL
89409GSK	Front	1964 - 1969 - N and NT 89" BBC Conventional Cab - N-800, N-850, N-900 Gas w/ 6,000/ 7,000 lb Axles	C6PF-18077-DL
89409GSK	n/a	Additional OEM Interchanges	C7HZ-18124-A
89409GSK	Front	1967 - 1971 - C & CT Series - Tilt Cab - C-600, C-650, C-700, C-750, C-800, C-850, C-1000 w/ 7,000/ 9,000/ 11,000/ 12,000/ 15,000 lb Axles and 175" Wheel Base	C8HA-18045-A
89409GSK	Front	1969 - 1971 - C & CT Series - Tilt Cab - C-800, C-850, C-900, CT-800, CT-850, CT-900, CT-950 w/ 9,000/ 11,000/ 12,000/ 15,000 lb Axles	C8HA-18045-A
89409GSK	Front	1973 - 1989 - L, LT & LTS - Conventional Cab - LTS-800, LTS-850, LTS-900, LTS-9000 w/ 16,000 lb Axle	D0HA-18045-E
89409GSK	n/a	Additional OEM Interchanges	D0HZ-18124-B
89409GSK	Front	1971 - 1973 - C & CT Series - Tilt Cab - C-500, C-550, C-600, C-650, C-700, C-750 w/ 6,000/ 7,000 lb Axles	D1TF-18045-LA
89409GSK	Front	1972 - 1975 - C & CT Series - Tilt Cab - C-800, C-850, C-900, CT-800, CT-850, CT-900 w/ 11,000/ 12,000 lb Axles	D1TF-18045-LA
89409GSK	Front	1970 - 1975 - LN & LNT - Conventional Cab - LN-700, LN-750 Diesel w/ 9,000 lb Axle	D2EF-18045-AA
89409GSK	Front	1973 - 1979 - F Series - Conventional Cab - F-700 (Diesel), F-750 w/ 9,000 lb Axle	D2EF-18045-AA
89409GSK	Front	1976 - 1979 - C & CT Series - Tilt Cab - C-600, C-700, C-750, C-800, C-900, CT-800, CT-900	D2EF-18045-AA
89409GSK	Front	1976 - 1979 - LN & LNT - Conventional Cab - LN-600, LN-650, LN-700, LN-800	D2EF-18045-AA
89409GSK	Front	1976 - 1981 - L, LT & LTS - Conventional Cab - L-800	D2EF-18045-AA
89409GSK	Front	1978 - 1979 - F Series - Conventional Cab - F-800 w/ 9,000 lb Axle	D2EF-18045-AA

Part No.	Front/ Rear	Application & Model Information	OEM Part No.
89409GSK	Front	1980 - 1989 - LN & LNT - Conventional Cab - LN-600, LN-700, LN-7000, LN-800, LN-8000, LNT-800, LNT-8000 w/ 4,400 lb Spring and 7,000/ 9,000 lb Axles	D2EF-18045-AA
89409GSK	Front	1980 - 1990 - C & CT Series - Tilt Cab - C-600, C-700, C-800, C-7000, CT-800, CT-8000 w/ 4,040/ 5,040 lb Springs and 7,000/ 9,000/ 12,000 lb Axles	D2EF-18045-AA
89409GSK	n/a	Additional OEM Interchanges	D2EF-18124-AA
89409GSK	Front	1973 - 1989 - L, LT & LTS - Conventional Cab - LTS-800, LTS-850, LTS-900, LTS-9000 w/ 16,000 lb Axle	D2HF-18045-DA
89409GSK	n/a	Additional OEM Interchanges	D2HT-18045-EA
89409GSK	Front	1972 - 1979 - C & CT Series - Tilt Cab - C-750, C-800, C-850, C-900, CT-750, CT-800, CT-850, CT-900 w/ 9,000/ 11,000/ 12,000/ 15,000 lb Axles	D2KF-18045-AA
89409GSK	Front	1973 - 1990 - L, LT & LTS - Conventional Cab - L-800, L8000, L-900, L-9000, LT-800, LT-880, LT8000, LT-900, LT-9000 w/ 7,000/ 9,000/ 12,000 lb Axles	D2KF-18045-AA
89409GSK	Front	1976 - 1977 - LN & LNT - Conventional Cab - LN-800, LN-8000, LN-900, LN-9000, LNT-800, LNT-8000, LNT-900, LNT-9000	D2KF-18045-AA
89409GSK	n/a	Additional OEM Interchanges	D2KF-18124-AA
89409GSK	Front	1976 - 1979 - F Series - Conventional Cab - F-700	D2TF-18045-AA
89409GSK	Front	1976 - 1979 - F Series - Conventional Cab - F-800	D2TF-18045-AA
89409GSK	n/a	Additional OEM Interchanges	D2TZ-18124-E
89409GSK	n/a	Additional OEM Interchanges	D2TZ-18124-J
89409GSK	n/a	Additional OEM Interchanges	D5TZ-18124-C
89409GSK	Front	1973 - 1990 - L, LT & LTS - Conventional Cab - L-800, L8000, L-900, L-9000, LT-800, LT-880, LT8000, LT-900, LT-9000 w/ 7,000/ 9,000/ 12,000 lb Axles	D7HF-18045-FA
89409GSK	Front	1973 - 1979 - F Series - Conventional Cab - F-700 (Diesel), F-750 w/ 9,000 lb Axle	D7HT-18045-BA
89409GSK	Front	1976 - 1979 - LN & LNT - Conventional Cab - LN-600, LN-650, LN-700, LN-801	D7HT-18045-BA
89409GSK	Front	1976 - 1981 - L, LT & LTS - Conventional Cab - L-800	D7HT-18045-BA
89409GSK	Front	1978 - 1979 - F Series - Conventional Cab - F-800 w/ 9,000 lb Axle	D7HT-18045-BA
89409GSK	Front	1973 - 1989 - L, LT & LTS - Conventional Cab - LTS-800, LTS-850, LTS-900, LTS-9000 w/ 16,000 lb Axle	D7HT-18045-EA
89409GSK	n/a	Additional OEM Interchanges	D7HT-18124-BA
89409GSK	n/a	Additional OEM Interchanges	D7HT-18124-EA
89409GSK	n/a	Additional OEM Interchanges	D7HT-18124-FA

Part No.	Front/ Rear	Application & Model Information	OEM Part No.
89409GSK	Front	1976 - 1979 - C & CT Series - Tilt Cab - C-600, C-700, C-750, C-800, C-900, CT-800, CT-900	D7KF-18045-EA
89409GSK	Front	1990 - 1997 - LN & LNT - Conventional Cab - LN-7000, LN-8000, LN-9000, LNT-8000, LNT-9000 w/ Multi-Leaf Spring	F1HT-18045-DA
89409GSK	Front	1991 - 1997 - L, LT & LTS - Conventional Cab - L-8000, L-9000, LT-8000, LT-9000 w/ Multi-Leaf Spring	F1HT-18045-DA
89409GSK	n/a	Additional OEM Interchanges	TANNA-18045-A
89410GSK	Rear	1994 - 1997 - F Series - Conventional Cab - F-700, F-800 w/ 21,000 lb Taper-Leaf Springs	F4HT-18080-BA
89410GSK	Rear	1994 - 1997 - FT Series - Conventional Cab - FT-900 w/ 46" Taper-Leaf Springs and 21,000 lb Axle	F4HT-18080-BA
89410GSK	Rear	1994 - 1997 - L, LT & LTS - Conventional Cab - L-8000, L-9000, LT-8000 or LT-9000 Series w/ 21,000/ 23,000 lb w/ 46" Taper-Leaf Spring	F4HT-18080-BA
89410GSK	Rear	1994 - 1997 - LN & LNT - Conventional Cab - LN-7000, LN-8000, LN-9000, LNT-8000 or LNT-9000 Series w/ 21,000/ 23,000 lb w/ 46" Taper-Leaf Spring	F4HT-18080-BA
89410GSK	Rear	Models w/ OEM Number	F5HZ-18125-B
89410GSK	Rear	1996 & Later - AeroMax (A, AT, AAT, 8500, 9500) Series - All w/ 21,000/ 23,000 lb Axles and 46" Taper-Leaf Spring	F5HZ-18125-B
89410GSK	Rear	Models w/ OEM Number	F5HZ-18125-BA
89413GSK	Front	1978 - 1979 - P-Series - Parcel Delivery - P-600	D7HT-18045-HA
89414GSK	Rear	Louisville Series - Conventional Cab - All w/ Hendrickson HAS-400 Air Suspension	47902-28
89414GSK	Rear	1991 - 1996 - LA, LS & LST - Conventional Cab - LA-8000, LA-9000 Series w/ Hendrickson Rear Air Suspension	47902-28
89414GSK	Rear	1991 - 1996 - LL, LLA, LTA, LTL, LTLA - Conventional Cab - LTA-9000, LLA-9000 or LTLA-9000 Series w/ Hendrickson Rear Air Suspension	47902-28
89414GSK	Rear	1996 - 1997 - AeroMax (A, AT, AAT, 8500, 9500) Series - All w/ Hendrickson HAS-400, HA-210 or HA-230 Air Suspension	47902-28
89414GSK	n/a	Additional OEM Interchanges	D2HZ-18080-A
89414GSK	Rear	1973 - 1977 - W and WT Series - Hi Tilt Cab Highway Tractor - W-900, WT-900 w/ Air Suspension	D2HZ-18080-A
89414GSK	n/a	Additional OEM Interchanges	D2HZ-18125-A
89414GSK	n/a	Additional OEM Interchanges	D2HZ-18125-B
89414GSK	n/a	Additional OEM Interchanges	D4HA-18080-A
89414GSK	Rear	CL & CLT Series - Highway Tractor Tilt Cab - Models w/ OEM Number	D4HA-18080-AA
89414GSK	Rear	1973 - 1977 - W and WT Series - Hi Tilt Cab Highway Tractor - W-900, WT-900 w/ Air Suspension	D4HA-18080-AA

Part No.	Front/ Rear	Application & Model Information	OEM Part No.
89414GSK	Rear	1978 - 1989 - CL & CLT Series - Highway Tractor Tilt Cab - CL-9000, CLT-9000 w/ Single Rear Axle Suspension	D4HA-18080-AA
89414GSK	Rear	Models w/ OEM Number	D8HZ-18125-A
89414GSK	Rear	Models w/ OEM Number	F6HT-18080-FC
89414GSK	Rear	Louisville Series - Conventional Cab - All w/ Hendrickson HAS-400 Air Suspension	F6HZ-18080-FC
89414GSK	Rear	1996 - 1997 - AeroMax (A, AT, AAT, 8500, 9500) Series - All w/ Hendrickson HAS-400, HA-210 or HA-230 Air Suspension	F6HZ-18080-FC
89414GSK	Rear	Louisville Series - Conventional Cab - All w/ Hendrickson HAS-400 Air Suspension	F6HZ-18125-D
89414GSK	Rear	Models w/ OEM Number	F6HZ-18125-D
89414GSK	Rear	1996 - 1997 - AeroMax (A, AT, AAT, 8500, 9500) Series - All w/ Hendrickson HAS-400, HA-210 or HA-230 Air Suspension	F6HZ-18125-D
89425GSK	Rear	1994 - 1997 - FT Series - Conventional Cab - FT-900 w/ 46" Taper-Leaf Spring and 15,000/ 17,500/ 19,000 lb Axles	F4HT-18080-AA
89425GSK	Rear	1994 - 1998 - F Series - Conventional Cab - F-700, F-800 w/ 15,000/ 17,500/ 19,000 lb Taper-Leaf Springs	F4HT-18080-AA
89425GSK	Rear	1994 - 1997 - FT Series - Conventional Cab - FT-900 w/ 46" Taper-Leaf Spring and 15,000/ 17,500/ 19,000 lb Axles	F4HT-18080-AB
89425GSK	Rear	1994 - 1998 - F Series - Conventional Cab - F-700, F-800 w/ 15,000/ 17,500/ 19,000 lb Taper-Leaf Springs	F4HT-18080-AB
89425GSK	Rear	Models w/ OEM Number	F5HZ-18125-A
89425GSK	Rear	1994 - 1998 - F Series - Conventional Cab - F-700, F-800 w/ 15,000/ 17,500/ 19,000 lb Taper-Leaf Springs	F5HZ-18125-A
89425GSK	Rear	1996 & Later - AeroMax (A, AT, AAT, 8500, 9500) Series - All w/ 23,000 lb Axle and 52" Taper-Leaf Spring	F5HZ-18125-A
89425GSK	Rear	Models w/ OEM Number	F5HZ-18125-AA
89425GSK	Rear	1994 - 1997 - FT Series - Conventional Cab - FT-900 w/ 46" Taper-Leaf Spring and 15,000/ 17,500/ 19,000 lb Axles	F5HZ-18125-DA
89425GSK	Rear	Models w/ OEM Number	F6HT-18080-CA
89425GSK	Rear	Models w/ OEM Number	F6HZ-18125-A
89430GSK	Rear	LN & LNT - Conventional Cab - LN-7000, LN-8000, LN-9000, LNT-8000, LNT-9000 w/ Hendrickson Rear Air Suspension	F0HT-18080-AA
89430GSK	Rear	LN & LNT - Conventional Cab - LN-7000, LN-8000, LN-9000, LNT-8000, LNT-9000 w/ Hendrickson Rear Air Suspension	F0HZ-18125-A
89435GSK	Front	Louisville Series - Conventional Cab - All w/ 54" Multi-Leaf Spring and w/ 12,000/ 13,200 lb Axles	F6HT-18045-BC

Part No.	Front/ Rear	Application & Model Information	OEM Part No.
89435GSK	Front	1996 & Later - AeroMax (A, AT, AAT, 8500, 9500) Series - 9500 (113" & 122" BBC) Series w/ 12,000/ 13,200 lb Axles and 54" Multi-Leaf Spring	F6HT-18045-BC
89438GSK	Front	1996 - AeroMax (A, AT, AAT, 8500, 9500) Series - 8000 Series w/ 16,000 lb Multi-Leaf Spring	F6HT-18045-AA
89438GSK	Front	1996 - LA, LS & LST - Conventional Cab - LA-8000 Series w/ 16,000 lb Multi-Leaf Spring	F6HT-18045-AA
89438GSK	Front	1996 - 1997 - CF Series (Brazilian Built) - CF-7000, CF-8000 or CFT-8000 Series w/ 16,000 lb Multi-Leaf Spring	F6HT-18045-AA
89438GSK	Front	1996 - 1997 - Louisville Series - Conventional Cab - All Models w/ 10,000/ 12,000 lb Axles and 54" Taper-Leaf Spring	F6HT-18045-AC
89438GSK	Front	1996 & Later - AeroMax (A, AT, AAT, 8500, 9500) Series - All Models w/ 10,000 / 12,000 lb Axles and 54" Taper-Leaf Spring	F6HT-18045-AC
89438GSK	Front	1996 - 1997 - Louisville Series - Conventional Cab - All w/ 8,500/ 9,000 lb Axles w/ 54" Taper-Leaf Spring	F6HT-18045-HB
89438GSK	Front	1996 - 1997 - AeroMax (A, AT, AAT, 8500, 9500) Series - 9500 (113" & 122" BBC) Series w/ 8,500/ 9,000 lb Axles and 54" Taper-Leaf Spring	F6HT-18045-HC
89438GSK	Front	1996 - 1997 - Louisville Series - Conventional Cab - All w/ 8,500/ 9,000 lb Axles w/ 54" Taper-Leaf Spring	F6HT-18045-HC
89438GSK	Front	1996 - 1997 - Louisville Series - Conventional Cab - All Models w/ 10,000/ 12,000 lb Axles and 54" Taper-Leaf Spring	F6HZ-18124-A
89438GSK	Front	1996 & Later - AeroMax (A, AT, AAT, 8500, 9500) Series - All Models w/ 10,000 / 12,000 lb Axles and 54" Taper-Leaf Spring	F6HZ-18124-A
89438GSK	Front	1996 & Later - AeroMax (A, AT, AAT, 8500, 9500) Series - All w/ 13,200/ 14,600 lb Axles and 54" Taper-Leaf Spring	F6HZ-18124-G
89438GSK	Front	1996 & Later - Louisville Series - Conventional Cab - All w/ 13,200/ 14,600 lb Axles w/ 54" Taper-Leaf Spring	F6HZ-18124-G
89438GSK	Front	1996 - 1997 - Louisville Series - Conventional Cab - All w/ 8,500/ 9,000 lb Axles w/ 54" Taper-Leaf Spring	F6HZ-18124-H
89439GSK	Front	1996 & Later - Louisville Series - Conventional Cab - All w/ 54" Multi-Leaf Spring and 14,600/ 16,000 lb Axles	F6HT-18045-CC
89439GSK	Front	1996 - 1997 - Louisville Series - Conventional Cab - All w/ 60" Taper-Leaf Spring and 12,000/ 13,000/ 14,600 lb Axles	F6HT-18045-EB
89439GSK	Front	1996 & Later - AeroMax (A, AT, AAT, 8500, 9500) Series - All w/ 12,000/ 13,000/ 14,600 lb Axles and 60" Taper-Leaf Spring	F6HT-18045-EB
89439GSK	Front	1996 - 1997 - Louisville Series - Conventional Cab - All w/ 60" Taper-Leaf Spring and 12,000/ 13,000/ 14,600 lb Axles	F6HT-18045-EC
89439GSK	Front	1996 & Later - AeroMax (A, AT, AAT, 8500, 9500) Series - All w/ 12,000/ 13,000/ 14,600 lb Axles and 60" Taper-Leaf Spring	F6HT-18045-EC
89439GSK	Front	1996 & Later - Louisville Series - Conventional Cab - All w/ 54" Multi-Leaf Spring and 14,600/ 16,000 lb Axles	F6HZ-18124-C

Part No.	Front/Rear	Application & Model Information	OEM Part No.
89439GSK	Front	1996 - 1997 - Louisville Series - Conventional Cab - All w/ 60" Taper-Leaf Spring and 12,000/ 13,000/ 14,600 lb Axles	F6HZ-18124-D
89439GSK	Front	1996 & Later - AeroMax (A, AT, AAT, 8500, 9500) Series - All w/ 12,000/ 13,000/ 14,600 lb Axles and 60" Taper-Leaf Spring	F6HZ-18124-D
89439GSK	Front	1996 - 1997 - Louisville Series - Conventional Cab - All w/ 60" Taper-Leaf Spring and 12,000/ 13,000/ 14,600 lb Axles	F6HZ-18124-E
89439GSK	Front	1996 & Later - AeroMax (A, AT, AAT, 8500, 9500) Series - All w/ 12,000/ 13,000/ 14,600 lb Axles and 60" Taper-Leaf Spring	F6HZ-18124-E
89439GSK	Front	1996 - 1997 - Louisville Series - Conventional Cab - All w/ 60" Taper-Leaf Spring and 12,000/ 13,000/ 14,600 lb Axles	F6HZ-18124-F
89439GSK	Front	1996 & Later - AeroMax (A, AT, AAT, 8500, 9500) Series - All w/ 12,000/ 13,000/ 14,600 lb Axles and 60" Taper-Leaf Spring	F6HZ-18124-F
89440GSK	Front	1996 & Later - AeroMax (A, AT, AAT, 8500, 9500) Series - All w/ 13,200/ 14,600 lb Axles and 54" Taper-Leaf Spring	F6HT-18045-GB
89440GSK	Front	1996 & Later - Louisville Series - Conventional Cab - All w/ 13,200/ 14,600 lb Axles w/ 54" Taper-Leaf Spring	F6HT-18045-GB
89440GSK	Front	1996 & Later - AeroMax (A, AT, AAT, 8500, 9500) Series - All w/ 13,200/ 14,600 lb Axles and 54" Taper-Leaf Spring	F6HT-18045-GC
89440GSK	Front	1996 & Later - Louisville Series - Conventional Cab - All w/ 13,200/ 14,600 lb Axles w/ 54" Taper-Leaf Spring	F6HT-18045-GC
89446GSK	Front	Models w/ OEM Number	AX267A
89446GSK	n/a	Additional OEM Interchanges	C1TZ-18124-D
89446GSK	n/a	Additional OEM Interchanges	C4HZ-18124-B
89446GSK	n/a	Additional OEM Interchanges	C4HZ-18124-E
89446GSK	n/a	Additional OEM Interchanges	D0HA-18045-D
89446GSK	n/a	Additional OEM Interchanges	D0HZ-18124-A
89446GSK	Front	1970 - 1989 - LN & LNT - Conventional Cab - LN-800, LN-850, LN-8000, LN-900, LN-9000, LNT-800, LNT-850, LNT-880, LNT-8000, LNT-900, LNT-9000 w/ 6,000/ 7,000/ 9,000/ 12,000/ 16,000 lb Axles	D2HF-18045-BA
89446GSK	Front	1973 - 1990 - L, LT & LTS - Conventional Cab - L-800, L850, L-900, L-9000, LT-800, LT-850, LT880, LT-900, LT-9000, LTS-800, LTS-850, LTS-900 w/ 7,000/ 9,000/ 12,000/ 16,000 lb Axles	D2HF-18045-BA
89446GSK	n/a	Additional OEM Interchanges	D2TF-18124-F
89446GSK	n/a	Additional OEM Interchanges	D2TZ-18124-F
89446GSK	Front	1970 - 1989 - LN & LNT - Conventional Cab - LN-800, LN-850, LN-8000, LN-900, LN-9000, LNT-800, LNT-850, LNT-880, LNT-8000, LNT-900, LNT-9000 w/ 6,000/ 7,000/ 9,000/ 12,000/ 16,000 lb Axles	D7HT-18045-DA
89446GSK	Front	1973 - 1990 - L, LT & LTS - Conventional Cab - L-800, L850, L-900, L-9000, LT-800, LT-850, LT880, LT-900, LT-9000, LTS-800, LTS-850, LTS-900 w/ 7,000/ 9,000/ 12,000/ 16,000 lb Axles	D7HT-18045-DA

Part No.	Front/ Rear	Application & Model Information	OEM Part No.
89446GSK	n/a	Additional OEM Interchanges	D7HT-18124-DA
89446GSK	Front	1980 - 1994 - F Series - Conventional Cab - F-600, F-6000, F-700, F-7000, F-800, F-8000, FT-700, FT-800, FT-8000 - Excluding 9,000 lb Axle w/ Heavy Duty Suspension & 12,000 lb Axle	E0HT-18045-AA
89446GSK	Front	1980 - 1996 - B - Series - Bus Cowl Chassis - B - 600, B - 700, B - 800, B - 7000	E0HT-18045-AA
89446GSK	Front	1980 - 1994 - F Series - Conventional Cab - F-600, F-6000, F-700, F-7000, F-800, F-8000, FT-700, FT-800, FT-8000 - Excluding 9,000 lb Axle w/ Heavy Duty Suspension & 12,000 lb Axle	E0HT-18045-AB
89446GSK	Front	1980 - 1996 - B - Series - Bus Cowl Chassis - B - 600, B - 700, B - 800, B - 7000	E0HT-18045-AB
89446GSK	n/a	Additional OEM Interchanges	E0HZ-18124-A
89446GSK	n/a	Additional OEM Interchanges	E1TA-18045-AA
89446GSK	n/a	Additional OEM Interchanges	E1TD-18045-AA
89446GSK	Front	1989 - 1994 - F Series - Conventional Cab - F-600, F-700, LPO (Low Profile Vehicle)	E9HS-18045-AA
89446GSK	Front	1990 - 1994 - FT Series - Conventional Cab - FT-900 (Low Profile Vehicle)	E9HS-18045-AA
89446GSK	Front	1990 - 1994 - FT Series - Conventional Cab - FT-900 w/ 9,000 lb Axle w/ Heavy Duty Suspension or 10,000/ 11,000/ 12,000 lb Axles	E9HS-18045-AA
89446GSK	Front	1990 - 1994 - FT Series - Conventional Cab - FT-900 (Low Profile Vehicle)	E9HZ-18124-A
89446GSK	Front	1990 - F Series - Conventional Cab - F-600, F-700, F-800, FT-800, FT-900, w/ Multi-Leaf Spring	F1HT-18045-AA
89446GSK	Front	1980 - 1996 - B - Series - Bus Cowl Chassis - B - 600, B - 700, B - 800, B - 7000	F1HT-18045-AA
89446GSK	Front	1990 - 1994 - FT Series - Conventional Cab - FT-900 w/ 9,000 lb Axle w/ Heavy Duty Suspension or 10,000/ 11,000/ 12,000 lb Axles	F1HT-18045-AA
89446GSK	Front	1990 - 1994 - FT Series - Conventional Cab - FT-900 w/ 9,000 lb Axle w/ Heavy Duty Suspension or 10,000/ 11,000/ 12,000 lb Axles	F1HZ-18124-A
89446GSK	Front	Models w/ OEM Number	F1HZ-18124-AA
89446GSK	n/a	Additional OEM Interchanges	TQSH-18045-A

FREIGHTLINER

Table 7-94: Suspension & Ride Control - Shock Application: Freightliner

Part No.	Front/ Rear	Application & Model Information	OEM Part No.
89406GSK	Rear	Freightliner Additional OEM Numbers - Models w/ OEM Number	47902-13
89412GSK	Rear	Business Class - FL50, 60, 70, 80 - FAS Airliner, Single / Tandem Past Production	16-11133-000
89412GSK	Rear	Freightliner Additional OEM Numbers - Models w/ OEM Number	16-11133-000
89412GSK	Rear	FLA & FLB Series - COE Truck & Tractor - COE Series w/ Convoluted Spring Air Suspension	16-12117-000
89412GSK	Rear	FLC & FLD Series - 112 & 120 Conventional Truck & Tractor - Conventional Series w/ Convoluted Spring Air Suspension	16-12117-000
89412GSK	Rear	FLA & FLB Series - COE Truck & Tractor - COE Series w/ Convoluted Spring Air Suspension	16-18705-000
89412GSK	Rear	FLC & FLD Series - 112 & 120 Conventional Truck & Tractor - Conventional Series w/ Convoluted Spring Air Suspension	16-18705-000
89412GSK	Rear	FLA & FLB Series - COE Truck & Tractor - COE Series w/ Convoluted Spring Air Suspension	665236
89412GSK	Rear	FLC & FLD Series - 112 & 120 Conventional Truck & Tractor - Conventional Series w/ Convoluted Spring Air Suspension	665236
89419GSK	n/a	Freightliner Additional OEM Numbers - Additional OEM Interchanges	680008
89420GSK	Front	Freightliner Additional OEM Numbers - Models w/ OEM Number	535228
89420GSK	Front	Classic/Classic XL - Models w/ OEM Number	680009
89420GSK	Front	Freightliner Additional OEM Numbers - Models w/ OEM Number	680009
89420GSK	n/a	Freightliner Additional OEM Numbers - Additional OEM Interchanges	680017
89420GSK	Front	Freightliner Additional OEM Numbers - Models w/ OEM Number	70042
89422GSK	Front	Classic/Classic XL - Models w/ OEM Number	70029
89422GSK	Front	Freightliner Additional OEM Numbers - Models w/ OEM Number	70029
89428GSK	Rear	Pre - 1994 - FLA & FLB Series - COE Truck & Tractor - COE Series w/ Airliner Rolling Lobe Spring Air Suspension	16-13947-000
89428GSK	Rear	Pre - 1994 - FLC & FLD Series - 112 & 120 Conventional Truck & Tractor - Conventional Series w/ Airliner Rolling Lobe Spring Air Suspension	16-13947-000
89428GSK	Rear	Freightliner Additional OEM Numbers - Models w/ OEM Number	680442
89428GSK	Rear	Pre - 1994 - FLA & FLB Series - COE Truck & Tractor - COE Series w/ Airliner Rolling Lobe Spring Air Suspension	681-326-0400
89428GSK	Rear	Pre - 1994 - FLC & FLD Series - 112 & 120 Conventional Truck & Tractor - Conventional Series w/ Airliner Rolling Lobe Spring Air Suspension	681-326-0400

Part No.	Front/ Rear	Application & Model Information	OEM Part No.
89429GSK	Front	FLA & FLB Series - COE Truck & Tractor - COE Series	10-12030-002
89429GSK	Front	FLC & FLD Series - 112 & 120 Conventional Truck & Tractor - Conventional Series w/ OEM Number	10-12030-002
89429GSK	Front	FLA & FLB Series - COE Truck & Tractor - COE Series	10-12032-000
89429GSK	Front	FLC & FLD Series - 112 & 120 Conventional Truck & Tractor - Conventional Series w/ OEM Number	10-12032-000
89429GSK	Front	FLA & FLB Series - COE Truck & Tractor - COE Series	10-12032-001
89429GSK	Front	FLC & FLD Series - 112 & 120 Conventional Truck & Tractor - Conventional Series w/ OEM Number	10-12032-001
89429GSK	Front	Classic/Classic XL - Models w/ OEM Number	10-12032-002
89429GSK	Front	FLA & FLB Series - COE Truck & Tractor - COE Series	10-12032-002
89429GSK	Front	FLC & FLD Series - 112 & 120 Conventional Truck & Tractor - Conventional Series w/ OEM Number	10-12032-002
89429GSK	Front	FLA & FLB Series - COE Truck & Tractor - COE Series	10-12032-003
89429GSK	Front	FLC & FLD Series - 112 & 120 Conventional Truck & Tractor - Conventional Series w/ OEM Number	10-12032-003
89429GSK	Front	Classic/Classic XL - Models w/ OEM Number	10-12032-004
89429GSK	Front	FLA & FLB Series - COE Truck & Tractor - COE Series	10-12032-004
89429GSK	Front	FLC & FLD Series - 112 & 120 Conventional Truck & Tractor - Conventional Series w/ OEM Number	10-12032-004
89429GSK	Front	Freightliner Additional OEM Numbers - Models w/ OEM Number	10-12046-000
89430GSK	Front	Freightliner Additional OEM Numbers - Models w/ 7,000 lb Front Suspension	10-13776-000
89430GSK	n/a	Freightliner Additional OEM Numbers - Additional OEM Interchanges	10-13859-000
89430GSK	Front	Freightliner Additional OEM Numbers - Models w/ OEM Number	659300
89431GSK	Front	Freightliner Additional OEM Numbers - Models w/ OEM Number	16-19138-000
89436GSK	Front	Freightliner Additional OEM Numbers - Models w/ OEM Number	16-14759-000
89443GSK	Rear	Pre - 1998 - Argosy - Models w/ Freightliner FAS II Rear Air Suspension	16-13957-000
89443GSK	Rear	Pre - 1998 - Business Class - FL50, 60, 70, 80 - FL Series w/ FAS II Rear Air Suspension	16-13957-000
89443GSK	Rear	Pre - 1998 - Cargo - FC70 & FC80 - FC70 & FC80 Series w/ FAS II Rear Air Suspension	16-13957-000
89443GSK	Rear	Pre - 1998 - Century Class - C112 & C120 - Models w/ FAS II Rear Air Suspension	16-13957-000
89443GSK	Rear	Pre - 1998 - Classic/Classic XL - Models w/ FASII Rear Air Suspension	16-13957-000
89443GSK	Rear	Pre - 1998 - FLA & FLB Series - COE Truck & Tractor - COE Series w/ FASII Rear Air Suspension	16-13957-000

Part No.	Front/ Rear	Application & Model Information	OEM Part No.
89443GSK	Rear	Pre - 1998 - FLC & FLD Series - 112 & 120 Conventional Truck & Tractor - Conventional Series w/ FASII Rear Air Suspension	16-13957-000
89443GSK	Rear	Pre - 1998 - Legacy - Models w/ FAS II Rear Air Suspension	16-13957-000
89443GSK	Rear	2008 - Cascadia - Models w/ FAS II Rear Air Suspension	16-15817-000
89443GSK	Rear	1999 - 2008 - Century Class - C112 & C120 - Models w/ FAS II Rear Air Suspension	16-15817-000
89443GSK	Rear	1999 - 2008 - Classic/Classic XL - Models w/ FASII Rear Air Suspension	16-15817-000
89443GSK	Rear	1999 - 2008 - Columbia - Models w/ FAS II Rear Air Suspension	16-15817-000
89443GSK	Rear	1999 - 2008 - FLC & FLD Series - 112 & 120 Conventional Truck & Tractor - Conventional Series w/ FASII Rear Air Suspension	16-15817-000
89443GSK	Rear	1999 & Later - Argosy - Models w/ Freightliner FAS II Rear Air Suspension	16-15817-000
89443GSK	Rear	1999 & Later - Business Class - FL50, 60, 70, 80 - FL Series w/ FAS II Rear Air Suspension	16-15817-000
89443GSK	Rear	1999 & Later - Cargo - FC70 & FC80 - FC70 & FC80 Series w/ FAS II Rear Air Suspension	16-15817-000
89443GSK	Rear	1999 & Later - FLA & FLB Series - COE Truck & Tractor - COE Series w/ FASII Rear Air Suspension	16-15817-000
89443GSK	Rear	1999 & Later - Legacy - Models w/ FAS II Rear Air Suspension	16-15817-000
89443GSK	Rear	2002 - 2008 - Business Class - M2 - Models w/ FAS II Rear Air Suspension	16-15817-000
89443GSK	Rear	2004 - 2008 - Coronado - Models w/ FAS II Rear Air Suspension	16-15817-000
89443GSK	Rear	2009 - 2010 - Century Class - C112 & C120 - Models w/ FAS II Rear Air Suspension	16-18708-000
89443GSK	Rear	2009 - 2010 - Classic/Classic XL - Models w/ FAS II Rear Air Suspension	16-18708-000
89443GSK	Rear	2009 - 2010 - Columbia - Models w/ FAS II Rear Air Suspension	16-18708-000
89443GSK	Rear	2009 - 2010 - FLC & FLD Series - 112 & 120 Conventional Truck & Tractor - Models w/ FAS II Rear Air Suspension	16-18708-000
89443GSK	Rear	2009 - 2011 - Business Class - M2 - Models w/ FAS II Rear Air Suspension	16-18708-000
89443GSK	Rear	2009 - 2011 - Cascadia - Models w/ FAS II Rear Air Suspension	16-18708-000
89443GSK	Rear	2009 - 2011 - Coronado - Models w/ FAS II Rear Air Suspension	16-18708-000
89443GSK	Rear	Pre - 1998 - Argosy - Models w/ Freightliner FAS II Rear Air Suspension	680339
89443GSK	Rear	Pre - 1998 - Business Class - FL50, 60, 70, 80 - FL Series w/ FAS II Rear Air Suspension	680339
89443GSK	Rear	Pre - 1998 - Cargo - FC70 & FC80 - FC70 & FC80 Series w/ FAS II Rear Air Suspension	680339

Part No.	Front/ Rear	Application & Model Information	OEM Part No.
89443GSK	Rear	Pre - 1998 - Century Class - C112 & C120 - Models w/ FAS II Rear Air Suspension	680339
89443GSK	Rear	Pre - 1998 - Classic/Classic XL - Models w/ FASII Rear Air Suspension	680339
89443GSK	Rear	Pre - 1998 - FLA & FLB Series - COE Truck & Tractor - COE Series w/ FASII Rear Air Suspension	680339
89443GSK	Rear	Pre - 1998 - FLC & FLD Series - 112 & 120 Conventional Truck & Tractor - Conventional Series w/ FASII Rear Air Suspension	680339
89443GSK	Rear	Pre - 1998 - Legacy - Models w/ FAS II Rear Air Suspension	680339
89443GSK	Rear	2008 - Cascadia - Models w/ FAS II Rear Air Suspension	680611
89443GSK	Rear	1999 - 2008 - Century Class - C112 & C120 - Models w/ FAS II Rear Air Suspension	680611
89443GSK	Rear	1999 - 2008 - Classic/Classic XL - Models w/ FASII Rear Air Suspension	680611
89443GSK	Rear	1999 - 2008 - Columbia - Models w/ FAS II Rear Air Suspension	680611
89443GSK	Rear	1999 - 2008 - FLC & FLD Series - 112 & 120 Conventional Truck & Tractor - Conventional Series w/ FASII Rear Air Suspension	680611
89443GSK	Rear	1999 & Later - Argosy - Models w/ Freightliner FAS II Rear Air Suspension	680611
89443GSK	Rear	1999 & Later - Business Class - FL50, 60, 70, 80 - FL Series w/ FAS II Rear Air Suspension	680611
89443GSK	Rear	1999 & Later - Cargo - FC70 & FC80 - FC70 & FC80 Series w/ FAS II Rear Air Suspension	680611
89443GSK	Rear	1999 & Later - FLA & FLB Series - COE Truck & Tractor - COE Series w/ FASII Rear Air Suspension	680611
89443GSK	Rear	1999 & Later - Legacy - Models w/ FAS II Rear Air Suspension	680611
89443GSK	Rear	2002 - 2008 - Business Class - M2 - Models w/ FAS II Rear Air Suspension	680611
89443GSK	Rear	2004 - 2008 - Coronado - Models w/ FAS II Rear Air Suspension	680611
89443GSK	Rear	2009 - 2010 - Century Class - C112 & C120 - Models w/ FAS II Rear Air Suspension	SDA471700002809
89443GSK	Rear	2009 - 2010 - Classic/Classic XL - Models w/ FAS II Rear Air Suspension	SDA471700002809
89443GSK	Rear	2009 - 2010 - Columbia - Models w/ FAS II Rear Air Suspension	SDA471700002809
89443GSK	Rear	2009 - 2010 - FLC & FLD Series - 112 & 120 Conventional Truck & Tractor - Models w/ FAS II Rear Air Suspension	SDA471700002809
89443GSK	Rear	2009 - 2011 - Business Class - M2 - Models w/ FAS II Rear Air Suspension	SDA471700002809
89443GSK	Rear	2009 - 2011 - Cascadia - Models w/ FAS II Rear Air Suspension	SDA471700002809
89443GSK	Rear	2009 - 2011 - Coronado - Models w/ FAS II Rear Air Suspension	SDA471700002809

Part No.	Front/ Rear	Application & Model Information	OEM Part No.
89449GSK	Front	Argosy - Models w/ 4" Taper-Leaf Front Suspension	10-12703-000
89449GSK	Front	Century Class - C112 & C120 - Models w/ Low Profile Front	10-12703-000
89449GSK	Front	2000 - 2008 - Columbia - Models w/ 12,000 lb Taper-Leaf Front Suspension	10-13021-000
89449GSK	Front	2000 - 2009 - Century Class - C112 & C120 - Models w/ 12,000 lb Taper-Leaf Front Suspension	10-13021-000
89449GSK	Front	2000 - 2009 - Classic/Classic XL - Models w/ 12,000 lb Taper-Leaf Front Suspension	10-13021-000
89449GSK	Front	2000 - 2009 - FLC & FLD Series - 112 & 120 Conventional Truck & Tractor - Conventional Series w/ 12,000 lb Taper-Leaf Front Suspension	10-13021-000
89449GSK	Front	2000 - 2008 - Columbia - Models w/ 12,000 lb Taper-Leaf Front Suspension	10-13063-000
89449GSK	Front	2000 - 2009 - Century Class - C112 & C120 - Models w/ 12,000 lb Taper-Leaf Front Suspension	10-13063-000
89449GSK	Front	2000 - 2009 - Classic/Classic XL - Models w/ 12,000 lb Taper-Leaf Front Suspension	10-13063-000
89449GSK	Front	2000 - 2009 - FLC & FLD Series - 112 & 120 Conventional Truck & Tractor - Conventional Series w/ 12,000 lb Taper-Leaf Front Suspension	10-13063-000
89449GSK	Front	2000 - 2008 - Columbia - Models w/ 12,000 lb Taper-Leaf Front Suspension	10-13211-000
89449GSK	Front	2000 - 2009 - Century Class - C112 & C120 - Models w/ 12,000 lb Taper-Leaf Front Suspension	10-13211-000
89449GSK	Front	2000 - 2009 - Classic/Classic XL - Models w/ 12,000 lb Taper-Leaf Front Suspension	10-13211-000
89449GSK	Front	2000 - 2009 - FLC & FLD Series - 112 & 120 Conventional Truck & Tractor - Conventional Series w/ 12,000 lb Taper-Leaf Front Suspension	10-13211-000
89449GSK	Front	2004 - 2009 - Coronado - Models w/ 12,000 lb Taper-Leaf Front Suspension	10-13211-000
89449GSK	Front	Pre - 2004 - Business Class - M2 - Models w/ Taper-Leaf Front Suspension	10-13211-000
89449GSK	Front	2008 - Cascadia - Models w/ 12,000 lb Taper-Leaf Front Suspension	10-13634-000
89449GSK	Front	Argosy - Models w/ 4" Taper-Leaf Front Suspension	10-13634-000
89449GSK	Front	2000 - 2008 - Columbia - Models w/ 12,000 lb Taper-Leaf Front Suspension	10-13634-000
89449GSK	Front	2000 - 2009 - Century Class - C112 & C120 - Models w/ 12,000 lb Taper-Leaf Front Suspension	10-13634-000

Part No.	Front/ Rear	Application & Model Information	OEM Part No.
89449GSK	Front	2000 - 2009 - Classic/Classic XL - Models w/ 12,000 lb Taper-Leaf Front Suspension	10-13634-000
89449GSK	Front	2000 - 2009 - FLC & FLD Series - 112 & 120 Conventional Truck & Tractor - Conventional Series w/ 12,000 lb Taper-Leaf Front Suspension	10-13634-000
89449GSK	Front	2005 - 2008 - Business Class - M2 - Models w/ Taper-Leaf Front Suspension	10-13634-000
89449GSK	Front	2008 - Cascadia - Models w/ 12,000 lb Taper-Leaf Front Suspension	471700000449
89449GSK	Front	Argosy - Models w/ 4" Taper-Leaf Front Suspension	471700000449
89449GSK	Front	2000 - 2008 - Columbia - Models w/ 12,000 lb Taper-Leaf Front Suspension	471700000449
89449GSK	Front	2000 - 2009 - Century Class - C112 & C120 - Models w/ 12,000 lb Taper-Leaf Front Suspension	471700000449
89449GSK	Front	2000 - 2009 - Classic/Classic XL - Models w/ 12,000 lb Taper-Leaf Front Suspension	471700000449
89449GSK	Front	2000 - 2009 - FLC & FLD Series - 112 & 120 Conventional Truck & Tractor - Conventional Series w/ 12,000 lb Taper-Leaf Front Suspension	471700000449
89449GSK	Front	2005 - 2008 - Business Class - M2 - Models w/ Taper-Leaf Front Suspension	471700000449
89449GSK	Front	2000 - 2008 - Columbia - Models w/ 12,000 lb Taper-Leaf Front Suspension	471700131155
89449GSK	Front	2000 - 2009 - Century Class - C112 & C120 - Models w/ 12,000 lb Taper-Leaf Front Suspension	471700131155
89449GSK	Front	2000 - 2009 - Classic/Classic XL - Models w/ 12,000 lb Taper-Leaf Front Suspension	471700131155
89449GSK	Front	2000 - 2009 - FLC & FLD Series - 112 & 120 Conventional Truck & Tractor - Conventional Series w/ 12,000 lb Taper-Leaf Front Suspension	471700131155
89449GSK	Front	2004 - 2009 - Coronado - Models w/ 12,000 lb Taper-Leaf Front Suspension	471700131155
89449GSK	Front	Pre - 2004 - Business Class - M2 - Models w/ Taper-Leaf Front Suspension	471700131155
89449GSK	Front	Freightliner Additional OEM Numbers - Models w/ OEM Number	61300224
89449GSK	Front	Freightliner Additional OEM Numbers - Models w/ OEM Number	671908
89453GSK	Front	2002 - 2009 - Century Class - C112 & C120 - Models w/ Hendrickson Front Airtek	58913-003
89453GSK	Front	2002 - 2009 - FLC & FLD Series - 112 & 120 Conventional Truck & Tractor - Conventional Series w/ Hendrickson Front Airtek	58913-003

Part No.	Front/ Rear	Application & Model Information	OEM Part No.
89453GSK	Front	2002 - May 2010 - Columbia - Models w/ Hendrickson Front Airtek	58913-003
89453GSK	Front	2004 - May 2010 - Coronado - Models w/ Hendrickson Front Airtek	58913-003
89453GSK	Front	Pre - 2009 - Classic/Classic XL - Models w/ Hendrickson Front Airtek	58913-003
89453GSK	Front	June 2010 & Later - Columbia - Models w/ Hendrickson Front Airtek	58913-012
89453GSK	Front	June 2010 & Later - Columbia - Models w/ Hendrickson Front Airtek	58913-012

FREIGHTLINER CUSTOM CHASSIS

Table 7-95: Suspension & Ride Control - Shock Application: Freightliner Custom Chassis

Part No.	Front/ Rear	Application & Model Information	OEM Part No.
89430GSK	n/a	Additional OEM Interchanges	10-13859-000
89431GSK	Front	MB55 Shuttle bus w/ 8,000 lb Flat Leaf Front Suspension	16-15676-000
89431GSK	Front	MT55 Utility Van w/ 8,000 lb Flat Leaf Front Suspension	16-15676-000
89431GSK	Front	MB55 & MT55 Models	16-17684-000
89431GSK	Front	Models w/ OEM Number	16-19138-000
89431GSK	Front	Models w/ OEM Number	654953
89431GSK	Front	Models w/ OEM Number	659227

FRUEHAUF

Table 7-96: Suspension & Ride Control - Shock Application: FRUEHAUF

Part No.	Front/ Rear	Application & Model Information	OEM Part No.
89419GSK	Rear	Models w/ OEM Number	144-5910
89406GSK	Rear	Tractor & Trailer Lift Axle w/ OEM Number	5116-117
89406GSK	Rear	All w/ Lift Axle	UCE-9399-1
89419GSK	n/a	Additional OEM Interchanges	680117
89419GSK	Rear	All w/ Air Suspension and OEM Number	UCE-1295-1
89419GSK	Rear	"T" Suspensions	UCE-1295-901
89436GSK	Rear	"L" Suspensions	UCD-006216-001

Part No.	Front/ Rear	Application & Model Information	OEM Part No.
89436GSK	Rear	Models w/ OEM Number	UCD-6216-1
89440GSK	Rear	Models w/ OEM Number	UEY 1124-001

FWD TRUCK

Table 7-97: Suspension & Ride Control - Shock Application: FWD TRUCK

Part No.	Front/ Rear	Application & Model Information	OEM Part No.
89420GSK	Front	Models w/ OEM Number	450739

GILLIG BROS.

Table 7-98: Suspension & Ride Control - Shock Application: Gillig Bros.

Part No.	Front/ Rear	Application & Model Information	OEM Part No.
89405GSK	Rear	Models w/ Neway ARD-234 Series Truck & Tractor Air Suspension (ARD-234-6)	90044046
89406GSK	Front	Models w/ OEM Number	82-01878
89406GSK	Rear	Models w/ OEM Number	90044683
89407GSK	Rear	Models w/ OEM Number	90044769
89407GSK	Rear	Models w/ OEM Number	90044770
89420GSK	n/a	Additional OEM Interchanges	680009
89420GSK	n/a	Additional OEM Interchanges	70034

GMC TRUCK

Table 7-99: Suspension & Ride Control - Shock Application: GMC Truck

Part No.	Front/ Rear	Application & Model Information	OEM Part No.
89406GSK	Rear	1999 - T - Series (T5500, T6500, T7500, T8500) - Models w/ Hendrickson Air Suspension (Stamping number 47902-13)	12474915
89406GSK	Rear	1995 - 1999 - C - Series (C6500, C7500, C8500) Topkick - Models w/ Hendrickson Air Suspension (Stamping number 47902-13)	12474915
89406GSK	Rear	1999 - T - Series (T5500, T6500, T7500, T8500) - Models w/ Hendrickson Air Suspension (Stamping number 47902-13)	15963161
89406GSK	Rear	1995 - 1999 - C - Series (C6500, C7500, C8500) Topkick - Models w/ Hendrickson Air Suspension (Stamping number 47902-13)	15963161
89407GSK	Front	1973 - 1975 - 6000 Series - C, S Chassis - Conventional Cab and School Bus - Excluding vehicles w/ 18,500/ 20,800/ 23,000 lb Rear Axle	22007750
89407GSK	Front	1973 - 1975 - 6500 Series - C, M, S Chassis - Conventional Cab and School Bus	22007750
89407GSK	Front	1973 - 1980 - 5000 Series - C, S Chassis - Conventional Cab	22007750
89407GSK	n/a	Additional OEM Interchanges	4940650
89407GSK	n/a	Additional OEM Interchanges	4940660
89407GSK	Front	1973 - 1975 - 6000 Series - C, S Chassis - Conventional Cab and School Bus - Excluding vehicles w/ 18,500/ 20,800/ 23,000 lb Rear Axle	4975467
89407GSK	Front	1973 - 1975 - 6500 Series - C, M, S Chassis - Conventional Cab and School Bus	4975467
89407GSK	Front	1973 - 1980 - 5000 Series - C, S Chassis - Conventional Cab	4975467
89407GSK	Front	1973 - 1975 - 6000 Series - C, S Chassis - Conventional Cab and School Bus - Excluding vehicles w/ 18,500/ 20,800/ 23,000 lb Rear Axle	4975494
89407GSK	Front	1973 - 1975 - 6500 Series - C, M, S Chassis - Conventional Cab and School Bus	4975494
89407GSK	Front	1973 - 1980 - 5000 Series - C, S Chassis - Conventional Cab	4975494
89407GSK	n/a	Additional OEM Interchanges	5532425
89407GSK	n/a	Additional OEM Interchanges	5532433
89407GSK	n/a	Additional OEM Interchanges	5549899
89407GSK	Rear	W - Series (Isuzu) - Models w/ OEM Number	90044769
89407GSK	Rear	W - Series (Isuzu) - Models w/ OEM Number	90044770
89413GSK	Rear	1983 - 1995 - W - Series (Isuzu) - W4 Series	8-51630-666-0
89413GSK	Rear	1989 - 1992 - W - Series (Isuzu) - W4 Series Flatlow	8-51630-666-0
89413GSK	Rear	W - Series (Isuzu) - W4 Series	9-51630-666-0

Part No.	Front/ Rear	Application & Model Information	OEM Part No.
89413GSK	Rear	W - Series (Isuzu) - Models w/ OEM Number	9-51630-666-2
89414GSK	Rear	1966 - 1972 - 7500 Series - 72" BBC Tilt Cab w/ V-6 2 Cycle Diesel Engine w/ 19101 and 19201 Axle	4940600
89414GSK	n/a	Additional OEM Interchanges	684280
89419GSK	n/a	Additional OEM Interchanges	3188626
89419GSK	n/a	Additional OEM Interchanges	4975429
89419GSK	n/a	Additional OEM Interchanges	5357955
89419GSK	n/a	Additional OEM Interchanges	5357959
89419GSK	n/a	Additional OEM Interchanges	5527001
89420GSK	n/a	Additional OEM Interchanges	5533699
89420GSK	Front	1966 - 1972 - 8500 Series - 72" BBC Tilt Cab	5544060
89420GSK	n/a	Additional OEM Interchanges	5544581
89420GSK	Front	1966 - 1972 - 9500 Series - 48" BBC Aluminum Tilt Cab	5552454
89420GSK	n/a	Additional OEM Interchanges	5554184
89420GSK	n/a	Additional OEM Interchanges	5554814
89422GSK	n/a	Additional OEM Interchanges	22012090
89422GSK	Front	1973 - 1980 - 7500 Series - R Chassis - Rear Engine Bus	22012090
89422GSK	Front	1973 - 1980 - 8500 Series - R Chassis - Rear Engine Bus	22012090
89422GSK	n/a	Additional OEM Interchanges	22012091
89422GSK	Front	1966 - 1972 - 9500 Series - 72" BBC Steel Tilt Cab	22012091
89422GSK	Rear	1970 - 1972 - 7500 Series - 72" BBC Tilt Cab w/ Air Brakes & Gas Engine	22012091
89422GSK	Rear	1973 - 1980 - 7500 Series - R Chassis - Rear Engine Bus	22012091
89422GSK	Front	1973 - 1980 - 7500 Series - T, W Chassis - 72" BBC Steel Tilt Cab w/ V-6 Gas Engine	22012091
89422GSK	Rear	1973 - 1980 - 8500 Series - R Chassis - Rear Engine Bus	22012091
89422GSK	Front	1973 - 1980 - 8500 Series - T, W Chassis - 72" BBC Steel Tilt Cab w/ V-6 Gas Engine	22012091
89422GSK	Front	1973 - 1980 - 9500 Series - T, W Chassis - 72" BBC Steel Tilt Cab	22012091
89422GSK	Front	Models w/ OEM Number	22046489
89422GSK	n/a	Additional OEM Interchanges	3172948
89422GSK	n/a	Additional OEM Interchanges	3188729
89422GSK	n/a	Additional OEM Interchanges	4939852
89422GSK	n/a	Additional OEM Interchanges	4939967
89422GSK	n/a	Additional OEM Interchanges	5353054
89422GSK	n/a	Additional OEM Interchanges	5374779
89422GSK	n/a	Additional OEM Interchanges	5392387
89422GSK	n/a	Additional OEM Interchanges	5522794

Part No.	Front/ Rear	Application & Model Information	OEM Part No.
89422GSK	n/a	Additional OEM Interchanges	5534430
89422GSK	n/a	Additional OEM Interchanges	5534447
89422GSK	n/a	Additional OEM Interchanges	5552210
89422GSK	n/a	Additional OEM Interchanges	5552244
89422GSK	Front	1973 - 1980 - 7500 Series - R Chassis - Rear Engine Bus	5552451
89422GSK	Front	1973 - 1980 - 8500 Series - R Chassis - Rear Engine Bus	5552451
89422GSK	Front	1966 - 1972 - 9500 Series - 72" BBC Steel Tilt Cab	5552452
89422GSK	Front	1970 - 1972 - 7500 Series - 72" BBC Tilt Cab w/ Air Brakes & Gas Engine	5552452
89422GSK	Rear	1973 - 1980 - 7500 Series - R Chassis - Rear Engine Bus	5552452
89422GSK	Front	1973 - 1980 - 7500 Series - T, W Chassis - 72" BBC Steel Tilt Cab w/ V-6 Gas Engine	5552452
89422GSK	Rear	1973 - 1980 - 8500 Series - R Chassis - Rear Engine Bus	5552452
89422GSK	Front	1973 - 1980 - 8500 Series - T, W Chassis - 72" BBC Steel Tilt Cab w/ V-6 Gas Engine	5552452
89422GSK	Front	1973 - 1980 - 9500 Series - T, W Chassis - 72" BBC Steel Tilt Cab	5552452
89422GSK	n/a	Additional OEM Interchanges	5554596
89430GSK	Front	1972 - 1980 - 4500 Series - PS4620 P, 4650P Step Van (Walk-in) 3/4" Upper bolt	22002293
89430GSK	Front	1973 - 1980 - 6000 Series - C, S, T Chassis - Conventional & Tilt Cab and School Bus w/ 5,000 & 7,000 lb Axle	22002293
89430GSK	Front	1973 - 1980 - 6500 Series - C, S, T Chassis - Conventional & Tilt Cab and School Bus	22002293
89430GSK	Front	1979 - 1980 - 6000 Series - W Chassis - 72" BBC Steel Tilt Cab	22002293
89430GSK	Front	1979 - 1980 - 6000 Series - W Chassis - 72" BBC Steel Tilt Cab	22002293
89430GSK	Front	1972 - 1976 - 4500 Series - PS4620 P, 4650P Step Van (Walk-in)	22007701
89430GSK	Front	1973 - 1980 - 6000 Series - C, S, T Chassis - Conventional & Tilt Cab and School Bus w/ 5,000 & 7,000 lb Axle	22007701
89430GSK	Front	1966 - 1969 - 7500 Series - 72" BBC Tilt Cab	22012095
89430GSK	Rear	1966 - 1972 - 4500 Series - EG-4500, EM-4500, ES-4500 Cab/Cowl w/ V-6 Gas or Diesel or In-line 6 Gas Engines	22012095
89430GSK	Front	1966 - 1972 - 5500 Series - CG-5500, CM-5500, T-5500 Conventional & Tilt Cab w/ V-6 Gas or Diesel Engines	22012095
89430GSK	Rear	1966 - 1972 - 5500 Series - EG-5500, EM-5500, ES-5500 Cab/Cowl w/ 6-Cylinder Engines	22012095
89430GSK	Front	1966 - 1972 - 6500 Series - CE-6500, ME-6500 Conventional Cab w/ V-8 Gas Engine w/ 11,000 lb Axle	22012095

Part No.	Front/ Rear	Application & Model Information	OEM Part No.
89430GSK	Front	1966 - 1972 - 6500 Series - CM-6500, TE-6500, TM-6500 Conventional Cab w/ V-6 Diesel or V-8 Gas Engine	22012095
89430GSK	Rear	1966 - 1972 - 6500 Series - EG-6500, DM-6500, ES-6500 Cab/Cowl w/ V-6 Gas or Diesel or In-line 6 Gas Engines	22012095
89430GSK	Front	1970 - 1972 - 7500 Series - 72" BBC Tilt Cab w/ Air Brakes - Excluding Gas Engine	22012095
89430GSK	Front	1972 - 1977 - 4500 Series - PS4620 P, 4650P Step Van (Walk-in)	22012095
89430GSK	Front	1973 - 1975 - 6500 Series - C, M Chassis - Conventional Cab w/ 9,000/ 12,000 lb Axle	22012095
89430GSK	Front	1973 - 1980 - 6000 Series - C, S, T Chassis - Conventional & Tilt Cab and School Bus w/ 5,000 & 7,000 lb Axle	22012095
89430GSK	Rear	1973 - 1980 - 6500 Series - C, M, S Chassis - Conventional Cab and School Bus w/ 20,800/ 23,000 lb Rear Axle	22012095
89430GSK	Front	1973 - 1980 - 6500 Series - C, S, T Chassis - Conventional & Tilt Cab and School Bus	22012095
89430GSK	Front	1973 - 1980 - 7500 Series - T, W Chassis - 72" BBC Steel Tilt Cab w/ V-6 Diesel Engine	22012095
89430GSK	Rear	1973 - 1989 - 5000 Series - C,S Chassis - Conventional Cab and School Bus	22012095
89430GSK	Rear	1973 - 1989 - 6000 Series - C, S Chassis - Conventional Cab and School Bus w/ 18,500/ 20,800/ 23,000 lb Rear Axle	22012095
89430GSK	Rear	1979 - 1989 - 7000 Series - C, M Chassis - 97" BBC Conventional Cab w/ 18,500/ 20,800/ 23,000 lb Rear Axle	22012095
89430GSK	Front	1977 - 4500 Series - PS4620 P, 4650P Step Van (Walk-in)	22012166
89430GSK	Rear	1973 - 1980 - 6500 Series - C, M, S Chassis - Conventional Cab and School Bus w/ 20,800/ 23,000 lb Rear Axle	22012166
89430GSK	Rear	1973 - 1989 - 5000 Series - C,S Chassis - Conventional Cab and School Bus	22012166
89430GSK	Rear	1973 - 1989 - 6000 Series - C, S Chassis - Conventional Cab and School Bus w/ 18,500/ 20,800/ 23,000 lb Rear Axle	22012166
89430GSK	Rear	1979 - 1989 - 7000 Series - C, M Chassis - 97" BBC Conventional Cab w/ 18,500/ 20,800/ 23,000 lb Rear Axle	22012166
89430GSK	Front	1966 - 1969 - 7500 Series - 72" BBC Tilt Cab	3171462
89430GSK	Rear	1966 - 1972 - 4500 Series - EG-4500, EM-4500, ES-4500 Cab/Cowl w/ V-6 Gas or Diesel or In-line 6 Gas Engines	3171462
89430GSK	Rear	1966 - 1972 - 5500 Series - EG-5500, EM-5500, ES-5500 Cab/Cowl w/ 6-Cylinder Engines	3171462
89430GSK	Rear	1966 - 1972 - 6500 Series - EG-6500, DM-6500, ES-6500 Cab/Cowl w/ V-6 Gas or Diesel or In-line 6 Gas Engines	3171462

Part No.	Front/ Rear	Application & Model Information	OEM Part No.
89430GSK	Front	1970 - 1972 - 7500 Series - 72" BBC Tilt Cab w/ Air Brakes - Excluding Gas Engine	3171462
89430GSK	Rear	1966 - 1972 - 4500 Series - EG-4500, EM-4500, ES-4500 Cab/Cowl w/ V-6 Gas or Diesel or In-line 6 Gas Engines	3192890
89430GSK	Front	1966 - 1972 - 5500 Series - CG-5500, CM-5500, T-5500 Conventional & Tilt Cab w/ V-6 Gas or Diesel Engines	3192890
89430GSK	Rear	1966 - 1972 - 5500 Series - EG-5500, EM-5500, ES-5500 Cab/Cowl w/ 6-Cylinder Engines	3192890
89430GSK	Front	1966 - 1972 - 6500 Series - CE-6500, ME-6500 Conventional Cab w/ V-8 Gas Engine w/ 11,000 lb Axle	3192890
89430GSK	Front	1966 - 1972 - 6500 Series - CM-6500, TE-6500, TM-6500 Conventional Cab w/ V-6 Diesel or V-8 Gas Engine	3192890
89430GSK	Rear	1966 - 1972 - 6500 Series - EG-6500, DM-6500, ES-6500 Cab/Cowl w/ V-6 Gas or Diesel or In-line 6 Gas Engines	3192890
89430GSK	Front	1972 - 1976 - 4500 Series - PS4620 P, 4650P Step Van (Walk-in)	3192890
89430GSK	Front	1973 - 1975 - 6500 Series - C, M Chassis - Conventional Cab w/ 9,000/ 12,000 lb Axle	3192890
89430GSK	Front	1973 - 1980 - 6000 Series - C, S, T Chassis - Conventional & Tilt Cab and School Bus w/ 5,000 & 7,000 lb Axle	3192890
89430GSK	Front	1973 - 1980 - 6500 Series - C, S, T Chassis - Conventional & Tilt Cab and School Bus	3192890
89430GSK	Front	1966 - 1969 - 7500 Series - 72" BBC Tilt Cab	4940606
89430GSK	Front	1966 - 1972 - 5500 Series - CG-5500, CM-5500, T-5500 Conventional & Tilt Cab w/ V-6 Gas or Diesel Engines	4940606
89430GSK	Front	1966 - 1972 - 6500 Series - CE-6500, ME-6500 Conventional Cab w/ V-8 Gas Engine w/ 11,000 lb Axle	4940606
89430GSK	Front	1966 - 1972 - 6500 Series - CM-6500, TE-6500, TM-6500 Conventional Cab w/ V-6 Diesel or V-8 Gas Engine	4940606
89430GSK	Front	1970 - 1972 - 7500 Series - 72" BBC Tilt Cab w/ Air Brakes - Excluding Gas Engine	4940606
89430GSK	Front	1972 - 1976 - 4500 Series - PS4620 P, 4650P Step Van (Walk-in)	4940606
89430GSK	Front	1973 - 1975 - 6500 Series - C, M Chassis - Conventional Cab w/ 9,000/ 12,000 lb Axle	4940606
89430GSK	Front	1973 - 1980 - 6000 Series - C, S, T Chassis - Conventional & Tilt Cab and School Bus w/ 5,000 & 7,000 lb Axle	4940606
89430GSK	Rear	1973 - 1980 - 6500 Series - C, M, S Chassis - Conventional Cab and School Bus w/ 20,800/ 23,000 lb Rear Axle	4940606
89430GSK	Front	1973 - 1980 - 6500 Series - C, S, T Chassis - Conventional & Tilt Cab and School Bus	4940606

Part No.	Front/ Rear	Application & Model Information	OEM Part No.
89430GSK	Front	1973 - 1980 - 7500 Series - T, W Chassis - 72" BBC Steel Tilt Cab w/ V-6 Diesel Engine	4940606
89430GSK	Rear	1973 - 1989 - 6000 Series - C, S Chassis - Conventional Cab and School Bus w/ 18,500/ 20,800/ 23,000 lb Rear Axle	4940606
89430GSK	Front	1973 - 1980 - 6000 Series - C, S, T Chassis - Conventional & Tilt Cab and School Bus w/ 5,000 & 7,000 lb Axle	4940662
89430GSK	Front	1972 - 1976 - 4500 Series - PS4620 P, 4650P Step Van (Walk-in)	4975497
89430GSK	Front	1973 - 1975 - 6500 Series - C, M Chassis - Conventional Cab w/ 9,000/ 12,000 lb Axle	4975497
89430GSK	Front	1973 - 1980 - 6000 Series - C, S, T Chassis - Conventional & Tilt Cab and School Bus w/ 5,000 & 7,000 lb Axle	4975497
89430GSK	Front	1973 - 1980 - 6500 Series - C, S, T Chassis - Conventional & Tilt Cab and School Bus	4975497
89430GSK	Front	1973 - 1980 - 7500 Series - T, W Chassis - 72" BBC Steel Tilt Cab w/ V-6 Diesel Engine	4975497
89436GSK	n/a	Additional OEM Interchanges	4940627
89436GSK	n/a	Additional OEM Interchanges	5348631
89436GSK	n/a	Additional OEM Interchanges	5559363
89440GSK	Front	Models w/ OEM Number	22065251

GRANNING SUSPENSION

Table 7-100: Suspension & Ride Control - Shock Application: Granning Suspension

Part No.	Front/ Rear	Application & Model Information	OEM Part No.
89419GSK	Rear	Models w/ OEM Number	680162

GREAT DANE TRAILER

Table 7-101: Suspension & Ride Control - Shock Application: GREAT DANE TRAILER

Part No.	Front/ Rear	Application & Model Information	OEM Part No.
89406GSK	Rear	Reyco Suspension 88	18164-01
89407GSK	Rear	Reyco Suspension 87	18163-01
89436GSK	Rear	Trailers w/ Great Dane part number	HENS-20001
89436GSK	Rear	Trailers w/ Great Dane part number	HENS-20002
89436GSK	Rear	Trailers w/ Great Dane part number	HENS-20126
89436GSK	Rear	Trailers w/ Great Dane part number	HENS-23566
89436GSK	Rear	Trailers w/ Great Dane part number	HENS-24088

GREYHOUND BUS

Table 7-102: Suspension & Ride Control - Shock Application: GREYHOUND BUS

Part No.	Front/ Rear	Application & Model Information	OEM Part No.
89422GSK	Front/Rear	City Cruiser	12 TA-01-013

HARDEE MFG

Table 7-103: Suspension & Ride Control - Shock Application: HARDEE MFG

Part No.	Front/ Rear	Application & Model Information	OEM Part No.
89407GSK	Rear	Models w/ OEM Number	8030223

HENDRICKSON TRAILER SUSPENSION SYSTEMS

Table 7-104: Suspension & Ride Control - Shock Application: HENDRICKSON TRAILER SUSPENSION SYSTEMS

Part No.	Front/ Rear	Application & Model Information	OEM Part No.
89437GSK	Rear	Models w/ OEM Number and rear suspension - Other Applications	680570
89414GSK	Rear	Others - Models w/ OEM Number	665532
89414GSK	Rear	UnderSlung Style - T-9-084	A-2240
89414GSK	Rear	Others - Models w/ OEM Number	A-4089
89414GSK	Rear	Others - Models w/ OEM Number	S-2240
89414GSK	Rear	Others - Models w/ OEM Number	S-4089
89430GSK	Rear	Others - Models w/ OEM Number	665533
89430GSK	Rear	Others - Models w/ OEM Number	A-20887
89430GSK	Rear	Others - Models w/ OEM Number	A-2230
89430GSK	Rear	Others - Models w/ OEM Number	A-2232
89430GSK	Rear	Top Mount Style - TMB-17-135	A-4084
89430GSK	Rear	UnderSlung Style - T-9-106, -278, -313	A-4084
89430GSK	Rear	Others - Models w/ OEM Number	S-20887
89430GSK	Rear	Others - Models w/ OEM Number	S-2230
89430GSK	Rear	Others - Models w/ OEM Number	S-2232
89430GSK	Rear	Others - Models w/ OEM Number	S-4084
89436GSK	Rear	Others - Models w/ OEM Number	654951
89436GSK	Rear	Others - Models w/ OEM Number	665531
89436GSK	Rear	Others - Models w/ OEM Number	665536
89436GSK	Rear	Others - Models w/ OEM Number	665756
89436GSK	Rear	Others - Models w/ OEM Number	665766
89436GSK	Rear	Others - Models w/ OEM Number	671948
89436GSK	Rear	Others - Models w/ OEM Number	680341
89436GSK	Rear	Others - Models w/ OEM Number	680467
89436GSK	Rear	Others - Models w/ OEM Number	680568
89436GSK	Rear	Others - Models w/ OEM Number	680702
89436GSK	Rear	Others - Models w/ OEM Number	680756
89436GSK	Rear	Others - Models w/ OEM Number	98583-019
89436GSK	Rear	Others - Models w/ OEM Number	A-14583
89436GSK	Rear	Others - AB-32-001	A-1667
89436GSK	Rear	UnderSlung Style - HT250U & N-HT250U - (U-7.5-021, U-7.5-022)	A-1667
89436GSK	Rear	UnderSlung Style - T-6-062, -295, -370, -422	A-1667
89436GSK	Rear	Others - Models w/ OEM Number	A-1668

Part No.	Front/ Rear	Application & Model Information	OEM Part No.
89436GSK	Rear	Others - HS190T (Slider Air Suspension)	A-20001
89436GSK	Rear	Top Mount Style - HT190T (All Models)	A-20001
89436GSK	Rear	UnderSlung Style - HT190U - (All except Models listed below)	A-20001
89436GSK	Rear	Intraax - AA230T & AA250T (Models w/ OEM Number)	A-20002
89436GSK	Rear	Others - HS230 (Slider Air Suspension)	A-20002
89436GSK	Rear	Top Mount Style - HT230T - (All except Models listed below)	A-20002
89436GSK	Rear	UnderSlung Style - HT190U - (U-7.5-517)	A-20002
89436GSK	Rear	UnderSlung Style - HT250U & N-HT250U - (All except Models listed below)	A-20002
89436GSK	Rear	UnderSlung Style - HT250U-Y (All Models)	A-20002
89436GSK	Rear	Intraax - AA230T & AA250T (Models w/ OEM Number)	A-20126
89436GSK	Rear	Top Mount Style - HT230T - (-14-17, -15-17,-15-517,-17-517,TA15-517,TA15-520,TA17-517)	A-20126
89436GSK	Rear	Top Mount Style - HT300T & N-HT300T - (All except Models listed below)	A-20126
89436GSK	Rear	UnderSlung Style - HT250U & N-HT250U - (U-6.5-517, U-7.5-17, U-7.5-517, U-9-517, U-12-517, U-14-514, UB6.5-517, UB7.5-517)	A-20126
89436GSK	Rear	UnderSlung Style - HT300U & N-HT300U - (All except Models listed below)	A-20126
89436GSK	Rear	Intraax - AA230T & AA250T (Models w/ OEM Number)	A-20889
89436GSK	Rear	Others - Models w/ OEM Number	B-21832
89436GSK	Rear	Others - Models w/ OEM Number	B-22715
89436GSK	Rear	Intraax - Low Ride Height Models w/ - (10-1/2" to 15" Ride Height)	B-23013
89436GSK	Rear	Intraax - AANT 23K - (Standard)	B-23566
89436GSK	Rear	Intraax - AAT 23K - (Standard)	B-23566
89436GSK	Rear	Intraax - AAT 25K - (Standard)	B-23566
89436GSK	Rear	Vantraax - HKA200 - (Standard)	B-23566
89436GSK	Rear	Vantraax - HKA250 - (Standard)	B-23566
89436GSK	Rear	Vantraax - HKANT 46K	B-23566
89436GSK	Rear	Vantraax - HKAT 46K	B-23566
89436GSK	Rear	Vantraax - HKA180	B-24088
89436GSK	Rear	Vantraax - HKANT 40K	B-24088
89436GSK	Rear	Intraax - AANT 23K - (Heavy Duty)	B-24125
89436GSK	Rear	Intraax - AAT 23K - (Heavy Duty)	B-24125
89436GSK	Rear	Intraax - AAT 25K - (Heavy Duty)	B-24125
89436GSK	Rear	Vantraax - HKA200 - (Heavy Duty)	B-24125

Part No.	Front/ Rear	Application & Model Information	OEM Part No.
89436GSK	Rear	Vantraax - HKA250 - (Heavy Duty)	B-24125
89436GSK	Rear	Others - Models w/ OEM Number	B-26652
89436GSK	Rear	Others - Models w/ OEM Number	B-29432
89436GSK	Rear	Others - Models w/ OEM Number	S-14583
89436GSK	Rear	Others - MT-45,MTL45,MTL-50	S-1667
89436GSK	Rear	Others - Models w/ OEM Number	S-1668
89436GSK	Rear	Others - Models w/ OEM Number	S-20001
89436GSK	Rear	Others - Models w/ OEM Number	S-20002
89436GSK	Rear	Others - Models w/ OEM Number	S-20126
89436GSK	Rear	Others - Models w/ OEM Number	S-20889
89436GSK	Rear	Others - Models w/ OEM Number	S-21832
89436GSK	Rear	Others - Models w/ OEM Number	S-23013
89436GSK	Rear	Others - Models w/ OEM Number	S-23566
89436GSK	Rear	Others - Models w/ OEM Number	S-24088
89436GSK	Rear	Others - Models w/ OEM Number	S-24125
89436GSK	Rear	Others - Models w/ OEM Number	S-26652
89436GSK	Rear	Others - Models w/ OEM Number	S-29432
89437GSK	Rear	HT250US (Models w/ Remote Shock Mount) w/ Rear suspension - UnderSlung Style	B-23316
89437GSK	Rear	Low Ride Height Models w/ rear suspension - Intraax	B-23316
89437GSK	Rear	Models w/ OEM Number and rear suspension - Other Applications	B-23362
89437GSK	Rear	Models w/ OEM Number - Other Applications	S-23316
89437GSK	Rear	Models w/ OEM Number and rear suspension - Other Applications	S-23362
89440GSK	Rear	Others - Models w/ OEM Number	665405
89440GSK	Rear	Others - Models w/ OEM Number	A-20886
89440GSK	Rear	Top Mount Style - T-15-140, -155, -172, 244, -376	A-2218
89440GSK	Rear	Top Mount Style - T-17-141, -174, -284	A-2218
89440GSK	Rear	UnderSlung Style - T-9-325	A-2218
89440GSK	Rear	Others - Models w/ OEM Number	S-20886
89440GSK	Rear	Others - Models w/ OEM Number	S-2218

HENDRICKSON TRUCK SUSPENSION SYSTEMS

Table 7-105: Suspension & Ride Control - Shock Application: HENDRICKSON TRUCK SUSPENSION SYSTEMS

Part No.	Front/ Rear	Application & Model Information	OEM Part No.
89405GSK	Rear	HA Series - HA Series Air Suspension (All Series used on Mack)	47902-19
89405GSK	Rear	Additional Applications - Models w/ OEM Number	47902-27
89405GSK	Rear	HA Series - HA Series Air Suspension (All Series used on Mack)	47902-9
89405GSK	Rear	Additional Applications - Models w/ OEM Number	59057-002
89405GSK	Rear	Additional Applications - Models w/ OEM Number	60665-004
89405GSK	Rear	Additional Applications - Models w/ OEM Number	60670-001
89405GSK	Rear	Additional Applications - Models w/ OEM Number	60670-004
89405GSK	Rear	HAS Series - HAS - 190L	60670-008
89405GSK	Rear	HAS Series - HAS - 210L	60670-008
89405GSK	Rear	HAS Series - HAS - 230L	60670-008
89405GSK	Rear	HAS Series - HAS - 400L	60670-008
89405GSK	Rear	HAS Series - HAS - 402L	60670-008
89405GSK	Rear	HAS Series - HAS - 460L	60670-008
89405GSK	Rear	Additional Applications - Models w/ OEM Number	654894
89405GSK	Rear	Additional Applications - Models w/ OEM Number	654898
89405GSK	Rear	Additional Applications - Models w/ OEM Number	659004
89405GSK	Rear	Additional Applications - Models w/ OEM Number	671006
89406GSK	Rear	HA Series - HA - 180 (Used on all except Mack)	47902-13
89406GSK	Rear	HA Series - HA - 200 (Used on all except Mack)	47902-13
89406GSK	Rear	HA Series - HA - 230 (Used on all except Mack)	47902-13
89406GSK	Rear	HA Series - HA - 360 (Used on all except Mack)	47902-13
89406GSK	Rear	HA Series - HA - 400 (Used on all except Mack)	47902-13
89406GSK	Rear	HA Series - HA - 460 (Used on all except Mack)	47902-13
89406GSK	Rear	HA Series - HA - 180 (Used on all except Mack)	47902-8
89406GSK	Rear	HA Series - HA - 200 (Used on all except Mack)	47902-8
89406GSK	Rear	HA Series - HA - 230 (Used on all except Mack)	47902-8
89406GSK	Rear	HA Series - HA - 360 (Used on all except Mack)	47902-8
89406GSK	Rear	HA Series - HA - 400 (Used on all except Mack)	47902-8
89406GSK	Rear	HA Series - HA - 460 (Used on all except Mack)	47902-8
89407GSK	Rear	Additional Applications - Models w/ OEM Number	47902-11
89407GSK	Rear	Additional Applications - Models w/ OEM Number	503610C2
89407GSK	Rear	HN - Series - HN - 400 - Models built between November 1988 - February 1996	60670-002

Part No.	Front/ Rear	Application & Model Information	OEM Part No.
89407GSK	Rear	HN - Series - HN - 460 - Models built between November 1988 - February 1996	60670-002
89407GSK	Rear	Additional Applications - Models w/ OEM Number	654890
89414GSK	Rear	Additional Applications - Models w/ OEM Number	47902-28
89414GSK	Rear	Additional Applications - Models w/ OEM Number	60670-009
89414GSK	Rear	Additional Applications - Models w/ OEM Number	654899
89422GSK	Rear	Additional Applications - Models w/ OEM Number	5554596
89422GSK	Rear	Additional Applications - Models w/ OEM Number	680091
89422GSK	Front	Additional Applications - Models w/ OEM Number	70018
89422GSK	Rear	Additional Applications - Models w/ OEM Number	70021
89422GSK	Rear	Additional Applications - Models w/ OEM Number	BE76164-2
89430GSK	Rear	Additional Applications - Models w/ OEM Number	47902-3
89440GSK	Rear	HN - Series - HNT - 460	47902-18
89453GSK	Front	Airtek Series - Airtek Front - Used on Freightliner / Western Star	58913-003
89453GSK	Front	Airtek Series - Airtek Front - Used on Freightliner / Western Star	58913-012
89454GSK	Front	Airtek Series - Airtek Front - Used on Freightliner / Western Star	64838-001
89454GSK	Front	Airtek Series - Airtek Front - Used on Volvo / Mack	64838-002

HIGHWAY PRODUCT

Table 7-106: Suspension & Ride Control - Shock Application: HIGHWAY PRODUCT

Part No.	Front/ Rear	Application & Model Information	OEM Part No.
89407GSK	Rear	Transit Bus w/ Leaf Spring Suspension	A1-6-134
89436GSK	Front	Transit Bus w/ Leaf Spring Suspension	A1-6-135

HINO

Table 7-107: Suspension & Ride Control - Shock Application: Hino

Part No.	Front/ Rear	Application & Model Information	OEM Part No.
89430GSK	Front	Additional Applications - Models w/ OEM Number	48500-3710
89430GSK	Front	2005 - 2009 - 145 SERIES - Trucks w/ OEM Number	48500-3710

Part No.	Front/ Rear	Application & Model Information	OEM Part No.
89430GSK	Front	2005 - 2009 - 165 SERIES - Trucks w/ OEM Number	48500-3710
89430GSK	Front	2005 - 2009 - 185 SERIES - Trucks w/ OEM Number	48500-3710
89430GSK	Front	2005 - 2009 - 145 SERIES - Trucks w/ OEM Number	485003710A
89430GSK	Front	2005 - 2009 - 165 SERIES - Trucks w/ OEM Number	485003710A
89430GSK	Front	2005 - 2009 - 185 SERIES - Trucks w/ OEM Number	485003710A
89430GSK	Front	2005 - 2009 - 145 SERIES - Trucks w/ OEM Number	S4850-03710
89430GSK	Front	2005 - 2009 - 165 SERIES - Trucks w/ OEM Number	S4850-03710
89430GSK	Front	2005 - 2009 - 185 SERIES - Trucks w/ OEM Number	S4850-03710

HOBBS TRAILERS

Table 7-108: Suspension & Ride Control - Shock Application: Hobbs Trailers

Part No.	Front/ Rear	Application & Model Information	OEM Part No.
89419GSK	Rear	Models w/ OEM Number	680117

HUTCHENS SUSPENSION

Table 7-109: Suspension & Ride Control - Shock Application: HUTCHENS SUSPENSION

Part No.	Front/ Rear	Application & Model Information	OEM Part No.
89436GSK	Rear	Models w/ OEM Number	9423-00

INTERNATIONAL (NAVISTAR)

Table 7-110: Suspension & Ride Control - Shock Application: INTERNATIONAL (NAVISTAR)

Part No.	Front/ Rear	Application & Model Information	OEM Part No.
89405GSK	Rear	F & S Series - 1600, 1700, 1800, 1900, 2100 Series w/ Neway ARD-234 Air Suspension	537524C91
89405GSK	Rear	F & S Series - 2275, F2275, 2524, F2524, 2554, F2554, 2574, F2574, 2575, F2575, F2624, F2654, F2674 Series w/ Neway ARD-234 Air Suspension	537524C91
89405GSK	Rear	S Series School Bus - 1723, 1823, 1853 Series w/ Neway ARD-234 Air Suspension	537524C91
89405GSK	Rear	Series 3000 - School Bus Chassis - 3700, 3800 Series w/ Neway ARD-234 Air Suspension	537524C91
89405GSK	Rear	Series 9600 & 9700 Premium Cabover Tractor - 9600, 9700 Series w/ Neway ARD-234 Air Suspension	537524C91
89405GSK	Rear	Series 3000 - School Bus Chassis - 3700, 3800 Series w/ Neway ARD-234 Air Suspension	537525C91
89407GSK	Rear	Series 9600 & 9700 Premium Cabover Tractor - 9600, 9700 Series w/ International STL Spring Suspension	503550C1
89407GSK	Rear	Models w/ OEM Number	503610C1
89407GSK	Front	Series 9300, 9300i, 9400 & 9400i Long Hood Conventional Truck & Tractor - Models w/ 10,800 - 14,600 lb Suspension	503610C2
89407GSK	Rear	Series 9300, 9300i, 9400 & 9400i Long Hood Conventional Truck & Tractor - Models w/ Hendrickson RS/RTE-380 Rear Air Suspension	503610C2
89407GSK	Front	Series 9600 & 9700 Premium Cabover Tractor - 9600, 9700 Series	503610C2
89407GSK	Front	Series 9600 & 9700 Premium Cabover Tractor - 9600, 9700 Series for Low Profile	503610C2
89407GSK	Front	Series 9800 - Premium Cabover Tractor - 9800 Series - w/ Set Forward axle	503610C2
89407GSK	Front	Series 9900, 9900i, 9900ix Long Hood Conventional Truck - Models w/ 10,800 - 14,600 lb Suspension	503610C2
89407GSK	Rear	Series 9900, 9900i, 9900ix Long Hood Conventional Truck - Models w/ Hendrickson RS/RTE-380 Rear Air Suspension	503610C2
89411GSK	Rear	F & S Series - 1600, 1700, 1800, 1900, 2100 Series w/ International Air Suspension	1675455C1
89411GSK	Rear	F & S Series - 2275, F2275, 2524, F2524, 2554, F2554, 2574, F2574, 2575, F2575, F2624, F2654, F2674 Series w/ International Corporate Air Suspension	1675455C1
89411GSK	Rear	F & S Series - 2275, F2275, 2524, F2524, 2554, F2554, 2574, F2574, 2575, F2575, F2624, F2654, F2674 Series w/ International Corporate Air Suspension - For Severe Use	1675455C1

Part No.	Front/ Rear	Application & Model Information	OEM Part No.
89411GSK	Rear	S Series School Bus - 1723, 1823, 1853 Series w/ International Air Suspension	1675455C1
89411GSK	Rear	Series 1000 Forward Control Chassis - 1452, 1652 Series w/ International Air Suspension	1675455C1
89411GSK	Rear	Series 2000 - Conventional Truck (Severe Service) - 2554, 2574, 2654, 2674 Series w/ International Air Suspension	1675455C1
89411GSK	Rear	Series 3000 - School Bus Chassis - 3700, 3800 Series w/ International Air Suspension	1675455C1
89411GSK	Rear	Series 4000 - Short Conventional Medium Truck & Tractor - 4600, 4700, 4800, 4900 Series w/ International Air Suspension (Excluding Low Profile)	1675455C1
89411GSK	Rear	Series 7000 - Short Conventional Medium Truck & Tractor - 7100 Series w/ International Air Suspension	1675455C1
89411GSK	Rear	Series 8000 - Conventional Heavy Duty Tractor - 8100, 8200, 8300 Series w/ International Air Suspension	1675455C1
89411GSK	Rear	Series 9200, 9200i - Tractor & Straight Truck - Models w/ International Air Suspension	1675455C1
89411GSK	Rear	Series 9300, 9300i, 9400 & 9400i Long Hood Conventional Truck & Tractor - Models w/ International Air Suspension	1675455C1
89411GSK	Rear	Series 9600 & 9700 Premium Cabover Tractor - 9600, 9700 Series w/ International Air Suspension	1675455C1
89411GSK	Rear	Series 9900, 9900i, 9900ix Long Hood Conventional Truck - Models w/ International Air Suspension	1675455C1
89411GSK	Rear	F & S Series - 1600, 1700, 1800, 1900, 2100 Series w/ International Air Suspension	1690035C1
89411GSK	Rear	F & S Series - 2275, F2275, 2524, F2524, 2554, F2554, 2574, F2574, 2575, F2575, F2624, F2654, F2674 Series w/ International Corporate Air Suspension	1690035C1
89411GSK	Rear	S Series School Bus - 1723, 1823, 1853 Series w/ International Air Suspension	1690035C1
89411GSK	Rear	Series 1000 Forward Control Chassis - 1452, 1652 Series w/ International Air Suspension	1690035C1
89411GSK	Rear	Series 2000 - Conventional Truck (Severe Service) - 2554, 2574, 2654, 2674 Series w/ International Air Suspension	1690035C1
89411GSK	Rear	Series 3000 - School Bus Chassis - 3700, 3800 Series w/ International Air Suspension	1690035C1
89411GSK	Rear	Series 4000 - Short Conventional Medium Truck & Tractor - 4600, 4700, 4800, 4900 Series w/ International Air Suspension (Excluding Low Profile)	1690035C1

Part No.	Front/ Rear	Application & Model Information	OEM Part No.
89411GSK	Rear	Series 7000 - Short Conventional Medium Truck & Tractor - 7100 Series w/ International Air Suspension	1690035C1
89411GSK	Rear	Series 8000 - Conventional Heavy Duty Tractor - 8100, 8200, 8300 Series w/ International Air Suspension	1690035C1
89411GSK	Rear	Series 9200, 9200i - Tractor & Straight Truck - Models w/ International Air Suspension	1690035C1
89411GSK	Rear	Series 9300, 9300i, 9400 & 9400i Long Hood Conventional Truck & Tractor - Models w/ International Air Suspension	1690035C1
89411GSK	Rear	Series 9600 & 9700 Premium Cabover Tractor - 9600, 9700 Series w/ International Air Suspension	1690035C1
89411GSK	Rear	Series 9900, 9900i, 9900ix Long Hood Conventional Truck - Models w/ International Air Suspension	1690035C1
89411GSK	Rear	F & S Series - 1600, 1700, 1800, 1900, 2100 Series w/ International Air Suspension	2018987C1
89411GSK	Rear	F & S Series - 2275, F2275, 2524, F2524, 2554, F2554, 2574, F2574, 2575, F2575, F2624, F2654, F2674 Series w/ International Corporate Air Suspension	2018987C1
89411GSK	Rear	S Series School Bus - 1723, 1823, 1853 Series w/ International Air Suspension	2018987C1
89411GSK	Rear	Series 1000 Forward Control Chassis - 1452, 1652 Series w/ International Air Suspension	2018987C1
89411GSK	Rear	Series 2000 - Conventional Truck (Severe Service) - 2554, 2574, 2654, 2674 Series w/ International Air Suspension	2018987C1
89411GSK	Rear	Series 3000 - School Bus Chassis - 3700, 3800 Series w/ International Air Suspension	2018987C1
89411GSK	Rear	Series 4000 - Short Conventional Medium Truck & Tractor - 4600, 4700, 4800, 4900 Series w/ International Air Suspension (Excluding Low Profile)	2018987C1
89411GSK	Rear	Series 7000 - Short Conventional Medium Truck & Tractor - 7100 Series w/ International Air Suspension	2018987C1
89411GSK	Rear	Series 8000 - Conventional Heavy Duty Tractor - 8100, 8200 & 8300 Series - 6 X 4 Models w/ International Air Suspension (Except Lo-Profile and Carhauler)	2018987C1
89411GSK	Rear	Series 9100, 9100i - Tractor & Straight Truck - 9100 Series - 4 X 2 w/ International Air Suspension	2018987C1
89411GSK	Rear	Series 9100, 9100i - Tractor & Straight Truck - 9100 Series - 6 X 4 w/ International Air Suspension	2018987C1
89411GSK	Rear	Series 9200, 9200i - Tractor & Straight Truck - 6 X 4 Models w/ International Air Suspension	2018987C1

Part No.	Front/ Rear	Application & Model Information	OEM Part No.
89411GSK	Rear	Series 9300, 9300i, 9400 & 9400i Long Hood Conventional Truck & Tractor - 6 X 4 Models w/ International Air Suspension Excluding Lo-Profile	2018987C1
89411GSK	Rear	Series 9600 & 9700 Premium Cabover Tractor - 9600, 9700 Series w/ International Air Suspension	2018987C1
89411GSK	Rear	Series 9800 - Premium Cabover Tractor - 9800 Series - 6 X 4 Models w/ International Air Suspension	2018987C1
89411GSK	Rear	Series 9900, 9900i, 9900ix Long Hood Conventional Truck - 6 X 4 Models w/ International Air Suspension Excluding Lo-Profile	2018987C1
89411GSK	Rear	August 12, 1994 & Later - Series 9200, 9200i - Tractor & Straight Truck - 4 X 2 Models w/ International Air Suspension	2018987C1
89411GSK	Rear	F & S Series - 1600, 1700, 1800, 1900, 2100 Series w/ International Air Suspension	501553C91
89411GSK	Rear	F & S Series - 2275, F2275, 2524, F2524, 2554, F2554, 2574, F2574, 2575, F2575, F2624, F2654, F2674 Series w/ International Corporate Air Suspension	501553C91
89411GSK	Rear	F & S Series - 2275, F2275, 2524, F2524, 2554, F2554, 2574, F2574, 2575, F2575, F2624, F2654, F2674 Series w/ International Corporate Air Suspension - For Standard Use	501553C91
89411GSK	Rear	S Series School Bus - 1723, 1823, 1853 Series w/ International Air Suspension	501553C91
89411GSK	Rear	Series 1000 Forward Control Chassis - 1452, 1652 Series w/ International Air Suspension	501553C91
89411GSK	Rear	Series 2000 - Conventional Truck (Severe Service) - 2554, 2574, 2654, 2674 Series w/ International Air Suspension	501553C91
89411GSK	Rear	Series 3000 - School Bus Chassis - 3700, 3800 Series w/ International Air Suspension	501553C91
89411GSK	Rear	Series 4000 - Short Conventional Medium Truck & Tractor - 4600, 4700, 4800, 4900 Series w/ International Air Suspension (Excluding Low Profile)	501553C91
89411GSK	Rear	Series 7000 - Short Conventional Medium Truck & Tractor - 7100 Series w/ International Air Suspension	501553C91
89411GSK	Rear	Series 8000 - Conventional Heavy Duty Tractor - 8100, 8200, 8300 Series w/ International Air Suspension	501553C91
89411GSK	Rear	Series 9200, 9200i - Tractor & Straight Truck - Models w/ International Air Suspension	501553C91
89411GSK	Rear	Series 9300, 9300i, 9400 & 9400i Long Hood Conventional Truck & Tractor - Models w/ International Air Suspension	501553C91
89411GSK	Rear	Series 9600 & 9700 Premium Cabover Tractor - 9600, 9700 Series w/ International Air Suspension	501553C91

Part No.	Front/ Rear	Application & Model Information	OEM Part No.
89411GSK	Rear	Series 9900, 9900i, 9900ix Long Hood Conventional Truck - Models w/ International Air Suspension	501553C91
89413GSK	Rear	S Series School Bus - 1603, 1703, 1803 & 1853	306444C91
89413GSK	Front	A, B, AC and BC Conventional - A-170, B-170, AC-170, BC-170, A-180, B-180, AC-180, BC-180	308646C91
89413GSK	Rear	A, B, AC and BC Conventional - ACF-170 & BCF-170	308646C91
89413GSK	Rear	Cargostar - CO-1600, CO-1610A & B, CO-1630A & B, CO-1700, CO-1710A & B, CO-1730A & B, CO-1750, CO-1750A & B, CO-1800, CO-1810A & B, CO-1830A & B, CO-1850, and CO-1850A & B	308646C91
89413GSK	Rear	A, B, AC and BC Conventional - C-150	308668C91
89413GSK	Front	Metro & Multi-Shop Series - M1600, MC1600, M1700 & MC1700	308668C91
89413GSK	Front	Loadstar - Conventional - 1600, 1600 (4x4), 1610, 1610 (4x4), 1700, 1700 (4x4), 1710, 1710 (4x4), F-1700, 1750, 1800, 1810, F-1800, F-1800-D, 1850, F-1850, 1890 & 1890-D Excluding Axle Codes 02054, 02057, 02059, 02089, 02091, 02098, 02101, 02109, 02139, 02208, 02218, 02228, 02309, 0232	308668C92
89413GSK	Front	S Series School Bus - 1603, 1703, 1803 & 1853 - Excluding Axle Codes 02054, 02057, 02059, 02089, 02091, 02098, 02101, 02109, 02139, 02208, 02218, 02228, 02309, 02329, 02339	308668C92
89413GSK	Front	Metro & Multi-Shop Series - M1600, MC1600, M1700 & MC1700	308669C91
89413GSK	Rear	Metro & Multi-Shop Series - MA1200, M1400, M1500, MA1500	308669C91
89413GSK	Front	S Series School Bus - 1603, 1703, 1803 & 1853 w/ 9,000/ 10,800/ 12,000 lb Front Axle	320444C91
89413GSK	Front	Loadstar - Conventional - 1600, 1600 (4x4), 1610, 1610 (4x4), 1610FC, 1700, 1700 (4x4), 1710, 1710 (4x4), F-1700, 1750, 1800, 1810, F-1800, F-1800-D, 1850, F-1850, 1890 & 1890-D w/ 9,000/ 10,800/ 12,000 lb Front Axle	329316C92
89413GSK	Rear	Loadstar - Conventional - 1600, 1600 (4x4), 1610, 1610 (4x4), 1700, 1700 (4x4), 1710, 1710 (4x4), 1750, 1800, 1810, 1850, 1890 & 1890-D	329316C92
89413GSK	Rear	S Series School Bus - 1603, 1703, 1803 & 1853	329316C92
89413GSK	Front	S Series School Bus - 1603, 1703, 1803 & 1853 w/ 9,000/ 10,800/ 12,000 lb Front Axle	329316C92
89413GSK	Rear	Cargostar - CO-1600, CO-1610A & B, CO-1630A & B, CO-1700, CO-1710A & B, CO-1730A & B, CO-1750, CO-1750A & B, CO-1800, CO-1810A & B, CO-1830A & B, CO-1850, and CO-1850A & B	360444C91
89413GSK	Front	Loadstar - Conventional - 1600, 1600 (4x4), 1610, 1610 (4x4), 1610FC, 1700, 1700 (4x4), 1710, 1710 (4x4), F-1700, 1750, 1800, 1810, F-1800, F-1800-D, 1850, F-1850, 1890 & 1890-D w/ 9,000/ 10,800/ 12,000 lb Front Axle	360444C91

Part No.	Front/ Rear	Application & Model Information	OEM Part No.
89413GSK	Rear	Loadstar - Conventional - 1600, 1600 (4x4), 1610, 1610 (4x4), 1700, 1700 (4x4), 1710, 1710 (4x4), 1750, 1800, 1810, 1850, 1890 & 1890-D	360444C91
89413GSK	Rear	A, B, AC and BC Conventional - C-150	453556C91
89413GSK	Front	Binder	453556C91
89413GSK	Front	Loadstar - Conventional - 1600, 1600 (4x4), 1610, 1610 (4x4), 1700, 1700 (4x4), 1710, 1710 (4x4), F-1700, 1750, 1800, 1810, F-1800, F-1800-D, 1850, F-1850, 1890 & 1890-D Excluding Axle Codes 02054, 02057, 02059, 02089, 02091, 02098, 02101, 02109, 02139, 02208, 02218, 02228, 02309, 0232	453556C91
89413GSK	Front	Metro & Multi-Shop Series - M1600, MC1600, M1700 & MC1700	453556C91
89413GSK	Rear	Metro & Multi-Shop Series - MA1200, M1400, M1500, MA1500	453556C91
89413GSK	Front	S Series School Bus - 1603, 1703, 1803 & 1853 - Excluding Axle Codes 02054, 02057, 02059, 02089, 02091, 02098, 02101, 02109, 02139, 02208, 02218, 02228, 02309, 02329, 02339	453556C91
89413GSK	Rear	Cargostar - CO-1600, CO-1610A & B, CO-1630A & B, CO-1700, CO-1710A & B, CO-1730A & B, CO-1750, CO-1750A & B, CO-1800, CO-1810A & B, CO-1830A & B, CO-1850, and CO-1850A & B	453564C91
89413GSK	Front	Loadstar - Conventional - 1600, 1600 (4x4), 1610, 1610 (4x4), 1610FC, 1700, 1700 (4x4), 1710, 1710 (4x4), F-1700, 1750, 1800, 1810, F-1800, F-1800-D, 1850, F-1850, 1890 & 1890-D w/ 9,000/ 10,800/ 12,000 lb Front Axle	453564C91
89413GSK	Rear	Loadstar - Conventional - 1600, 1600 (4x4), 1610, 1610 (4x4), 1700, 1700 (4x4), 1710, 1710 (4x4), 1750, 1800, 1810, 1850, 1890 & 1890-D	453564C91
89413GSK	Rear	S Series School Bus - 1603, 1703, 1803 & 1853	453564C91
89413GSK	Front	S Series School Bus - 1603, 1703, 1803 & 1853 w/ 9,000/ 10,800/ 12,000 lb Front Axle	453564C91
89413GSK	Front	Binder	467983C91
89413GSK	Rear	Cargostar - CO-1600, CO-1610A & B, CO-1630A & B, CO-1700, CO-1710A & B, CO-1730A & B, CO-1750, CO-1750A & B, CO-1800, CO-1810A & B, CO-1830A & B, CO-1850, and CO-1850A & B	467983C91
89413GSK	Front	Loadstar - Conventional - 1600	467983C91
89413GSK	Front	Loadstar - Conventional - 1600, 1600 (4x4), 1610, 1610 (4x4), 1610FC, 1700, 1700 (4x4), 1710, 1710 (4x4), F-1700, 1750, 1800, 1810, F-1800, F-1800-D, 1850, F-1850, 1890 & 1890-D w/ 9,000/ 10,800/ 12,000 lb Front Axle	467983C91
89413GSK	Rear	Loadstar - Conventional - 1600, 1600 (4x4), 1610, 1610 (4x4), 1700, 1700 (4x4), 1710, 1710 (4x4), 1750, 1800, 1810, 1850, 1890 & 1890-D	467983C91

Part No.	Front/ Rear	Application & Model Information	OEM Part No.
89413GSK	Front	S Series School Bus - 1603	467983C91
89413GSK	Rear	S Series School Bus - 1603, 1703, 1803 & 1853	467983C91
89413GSK	Front	S Series School Bus - 1603, 1703, 1803 & 1853 w/ 9,000/ 10,800/ 12,000 lb Front Axle	467983C91
89413GSK	Front	Binder	467985C91
89413GSK	Front	Loadstar - Conventional - 1600, 1600 (4x4), 1610, 1610 (4x4), 1700, 1700 (4x4), 1710, 1710 (4x4), F-1700, 1750, 1800, 1810, F-1800, F-1800-D, 1850, F-1850, 1890 & 1890-D Excluding Axle Codes 02054, 02057, 02059, 02089, 02091, 02098, 02101, 02109, 02139, 02208, 02218, 02228, 02309, 0232	467985C91
89413GSK	Front	S Series School Bus - 1603, 1703, 1803 & 1853 - Excluding Axle Codes 02054, 02057, 02059, 02089, 02091, 02098, 02101, 02109, 02139, 02208, 02218, 02228, 02309, 02329, 02339	467985C91
89413GSK	Front	Binder	471201C91
89413GSK	Front	Loadstar - Conventional - 1600	471201C91
89413GSK	Front	S Series School Bus - 1603	471201C91
89413GSK	Front	Loadstar - Conventional - 1600, 1600 (4x4), 1610, 1610 (4x4), 1700, 1700 (4x4), 1710, 1710 (4x4), F-1700, 1750, 1800, 1810, F-1800, F-1800-D, 1850, F-1850, 1890 & 1890-D Excluding Axle Codes 02054, 02057, 02059, 02089, 02091, 02098, 02101, 02109, 02139, 02208, 02218, 02228, 02309, 0232	874695R91
89413GSK	Front	Metro & Multi-Shop Series - M1600, MC1600, M1700 & MC1700	874695R91
89413GSK	Front	S Series School Bus - 1603, 1703, 1803 & 1853 - Excluding Axle Codes 02054, 02057, 02059, 02089, 02091, 02098, 02101, 02109, 02139, 02208, 02218, 02228, 02309, 02329, 02339	874695R91
89413GSK	Front	Loadstar - Conventional - 1600, 1600 (4x4), 1610, 1610 (4x4), 1700, 1700 (4x4), 1710, 1710 (4x4), F-1700, 1750, 1800, 1810, F-1800, F-1800-D, 1850, F-1850, 1890 & 1890-D Excluding Axle Codes 02054, 02057, 02059, 02089, 02091, 02098, 02101, 02109, 02139, 02208, 02218, 02228, 02309, 0232	874695R92
89413GSK	Front	Metro & Multi-Shop Series - M1600, MC1600, M1700 & MC1700	874696R91
89414GSK	Rear	F & S Series - 2275, F2275, 2524, F2524, 2554, F2554, 2574, F2574, 2575, F2575, F2624, F2654, F2674 Series w/ Neway ARD-125/244 Air Suspension	790335C91
89414GSK	Rear	Series 9300, 9300i, 9400 & 9400i Long Hood Conventional Truck & Tractor - Models w/ Neway ARD-125/244 Air Suspension	790335C91
89414GSK	Rear	Series 9600 & 9700 Premium Cabover Tractor - 9600, 9700 Series w/ Neway ARD-125/244 Air Suspension	790335C91
89414GSK	Rear	Series 9900, 9900i, 9900ix Long Hood Conventional Truck - Models w/ Neway ARD-125/244 Air Suspension	790335C91

Part No.	Front/ Rear	Application & Model Information	OEM Part No.
89414GSK	Rear	Models w/ OEM Number	90044025
89414GSK	Rear	Series 9800 - Premium Cabover Tractor - 9800 Series - w/ Hendrickson HAS-402-60 Air Suspension	AMS 650420
89414GSK	Rear	Series 4000 - Short Conventional Medium Truck & Tractor - 4000 Series w/ Hendrickson HAS-230 Rear Air Suspension	AMS650420
89418GSK	Front	Series 4000 - Short Conventional Medium Truck & Tractor - 4600, 4700, 4800, 4900 Series	1663606C91
89418GSK	Front	Series 7000 - Short Conventional Medium Truck & Tractor - 7100 Series	1663606C91
89419GSK	Rear	Cargostar - CO-190, VCO-190, CO-200, DCO-200, VCO-200, CO-220, VCO-220 W/ Air Ride Suspension After Chassis No G-387453	350425C1
89419GSK	Rear	Cargostar - CO-1950 w/ Air Ride Suspension After Chassis No. G-387453	350425C1
89419GSK	Rear	Fleetstar - Conventional - 2000D, 2010A, 2050A, 2070A, 2110A, 2150A w/ Air Ride Suspension After Chassis No G-387453	350425C1
89419GSK	Rear	Fleetstar - Conventional - F-2010A, F-2050A, F-2000D w/ Air Ride Suspension	350425C1
89419GSK	Rear	TranStar - Conventional - 4170, F-4170, 4200, F-4200, 4300 & F-4300 w/ Air Ride Suspension	350425C1
89419GSK	Rear	Cargostar - CO-190, VCO-190, CO-200, DCO-200, VCO-200, CO-220, VCO-220 W/ Air Ride Suspension After Chassis No G-387453	462557C91
89419GSK	Rear	Cargostar - CO-1950 w/ Air Ride Suspension After Chassis No. G-387453	462557C91
89419GSK	Rear	Co-TranStar and TranStar II - CO-4070A, COF-4070A, COF-4090A w/ Rear Suspension	462557C91
89419GSK	Rear	Fleetstar - Conventional - 2000D, 2010A, 2050A, 2070A, 2110A, 2150A w/ Air Ride Suspension After Chassis No G-387453	462557C91
89419GSK	Rear	Fleetstar - Conventional - F-2010A, F-2050A, F-2000D w/ Air Ride Suspension	462557C91
89419GSK	Rear	Loadstar - Conventional - 1700, 1750, 1800, 1850 w/ Air Ride Suspension	462557C91
89419GSK	Rear	TranStar - Conventional - 4170, F-4170, 4200, F-4200, 4300 & F-4300 w/ Air Ride Suspension	462557C91
89422GSK	Front	S Series School Bus - 1853 DFC3	210920R91
89422GSK	Front	S Series School Bus - 193 RE	210920R91
89422GSK	Front	Series 405 - DBF-405, DCF-405, DCOF-405 & VCOF-405 w/ Axle Code 02136	293009C91

Part No.	Front/ Rear	Application & Model Information	OEM Part No.
89422GSK	Front	Series 405 - DT-405, DBT-405, DCT-405, DCOT-405 & VCOT-405 w/ Axle Code 02136	293009C91
89422GSK	Front	TranStar - Conventional - D-400, DF-400, DC-400, DCF-400 & DCF-400M w/ Axle Code 02136	293009C91
89422GSK	Front	Co-TranStar and TranStar II - 7070B, F-7070B, CO-7070B & COF-7070B	426744R91
89422GSK	Front	Co-TranStar and TranStar II - CO-4010, COF-4010, COT-4010, COT-4010D, CO-4050, COF-4050, COT-4050, CO-4040A & B, CO-4070D, COF-4070B, COF-4070D, COT-4070D, COF-4077, COF-4077A, COF-4080D, CO-4090A, COF-4090A	426744R91
89422GSK	Front	Paystar - 5000 Series - 5010, F-5010, F-5050, F-5050SF, 5070, F-5070, F-5070SF	426744R91
89422GSK	Front	Series 405 - D-405, DB-405, DC-405, DCO-405, DF-405 & VCO-405 - Excluding Axle Code 02136	426744R91
89422GSK	Front	Series 405 - DBF-405, DCF-405, DCOF-405 & VCOF-405 w/ Axle Code 02136	426744R91
89422GSK	Front	Series 405 - DT-405, DBT-405, DCT-405, DCOT-405 & VCOT-405 - Excluding Axle Code 02136	426744R91
89422GSK	Front	Series 405 - DT-405, DBT-405, DCT-405, DCOT-405 & VCOT-405 w/ Axle Code 02136	426744R91
89422GSK	Front	Series 417 - DCO-417 & DCOF-417	426744R91
89422GSK	Front	TranStar - Conventional - 4170, F-4170, 4200, F-4200, 4300 & F-4300	426744R91
89422GSK	Front	TranStar - Conventional - D-400, DF-400, DC-400, DCF-400 & DCF-400M - Excluding Axle Code 02136	426744R91
89422GSK	Front Rear	Unistar - CO7044A	426744R91
89422GSK	Front	Co-TranStar and TranStar II - 7070B, F-7070B, CO-7070B & COF-7070B	426744R92
89422GSK	Front	Co-TranStar and TranStar II - CO-4010, COF-4010, COT-4010, COT-4010D, CO-4050, COF-4050, COT-4050, CO-4040A & B, CO-4070D, COF-4070B, COF-4070D, COT-4070D, COF-4077, COF-4077A, COF-4080D, CO-4090A, COF-4090A	426744R92
89422GSK	Front	Paystar - 5000 Series - 5010, F-5010, F-5050, F-5050SF, 5070, F-5070, F-5070SF	426744R92
89422GSK	Front	TranStar - Conventional - 4170, F-4170, 4200, F-4200, 4300 & F-4300	426744R92
89422GSK	Front	TranStar - Conventional - D-400, DF-400, DC-400, DCF-400 & DCF-400M - Excluding Axle Code 02136	426744R92
89422GSK	Front Rear	Unistar - CO7044A	426744R92

Part No.	Front/ Rear	Application & Model Information	OEM Part No.
89422GSK	Front	Co-TranStar and TranStar II - 7070B, F-7070B, CO-7070B & COF-7070B	453576C91
89422GSK	Front	Co-TranStar and TranStar II - CO-4010, COF-4010, COT-4010, COT-4010D, CO-4050, COF-4050, COT-4050, CO-4040A & B, CO-4070D, COF-4070B, COF-4070D, COT-4070D, COF-4077, COF-4077A, COF-4080D, CO-4090A, COF-4090A	453576C91
89422GSK	Front	Paystar - 5000 Series - 5010, F-5010, F-5050, F-5050SF, 5070, F-5070, F-5070SF	453576C91
89422GSK	Front	Series 405 - D-405, DB-405, DC-405, DCO-405, DF-405 & VCO-405 - Excluding Axle Code 02136	453576C91
89422GSK	Front	Series 405 - DBF-405, DCF-405, DCOF-405 & VCOF-405 w/ Axle Code 02136	453576C91
89422GSK	Front	Series 405 - DT-405, DBT-405, DCT-405, DCOT-405 & VCOT-405 - Excluding Axle Code 02136	453576C91
89422GSK	Front	Series 405 - DT-405, DBT-405, DCT-405, DCOT-405 & VCOT-405 w/ Axle Code 02136	453576C91
89422GSK	Front	Series 417 - DCO-417 & DCOF-417	453576C91
89422GSK	Front	TranStar - Conventional - 4170, F-4170, 4200, F-4200, 4300 & F-4300	453576C91
89422GSK	Front	TranStar - Conventional - D-400, DF-400, DC-400, DCF-400 & DCF-400M - Excluding Axle Code 02136	453576C91
89422GSK	Front Rear	Unistar - CO7044A	453576C91
89422GSK	Front	Co-TranStar and TranStar II - 7070B, F-7070B, CO-7070B & COF-7070B	453576C92
89422GSK	Front	Co-TranStar and TranStar II - CO-4010, COF-4010, COT-4010, COT-4010D, CO-4050, COF-4050, COT-4050, CO-4040A & B, CO-4070D, COF-4070B, COF-4070D, COT-4070D, COF-4077, COF-4077A, COF-4080D, CO-4090A, COF-4090A	453576C92
89422GSK	Front	F & S Series - 1600, 1700, 1800, 1900, 2100 Series	453576C92
89422GSK	Front	Loadstar - Conventional - M1600, M1700, M1800, M1900, M2100 Series	453576C92
89422GSK	Front	Loadstar - Conventional - M1600, M1700, M1800, M1900, M2100 Series	453576C92
89422GSK	Front	Paystar - 5000 Series - 5010, F-5010, F-5050, F-5050SF, 5070, F-5070, F-5070SF	453576C92
89422GSK	Front	Series 1000 Forward Control Chassis - 1452, 1652 Series	453576C92
89422GSK	Front	TranStar - Conventional - 4170, F-4170, 4200, F-4200, 4300 & F-4300	453576C92
89422GSK	Front	Series 405 - DBF-405, DCF-405, DCOF-405 & VCOF-405 w/ Axle Code 02136	453577C91

Part No.	Front/ Rear	Application & Model Information	OEM Part No.
89422GSK	Front	Series 405 - DT-405, DBT-405, DCT-405, DCOT-405 & VCOT-405 w/ Axle Code 02136	453577C91
89422GSK	Front	TranStar - Conventional - D-400, DF-400, DC-400, DCF-400 & DCF-400M w/ Axle Code 02136	453577C91
89422GSK	Front	S Series School Bus - 1853 DFC3	453579C91
89422GSK	Front	S Series School Bus - 193 RE	453579C91
89422GSK	Front	Co-TranStar and TranStar II - 7070B, F-7070B, CO-7070B & COF-7070B	477132C1
89422GSK	Front	Co-TranStar and TranStar II - CO-4010, COF-4010, COT-4010, COT-4010D, CO-4050, COF-4050, COT-4050, CO-4040A & B, CO-4070D, COF-4070B, COF-4070D, COT-4070D, COF-4077, COF-4077A, COF-4080D, CO-4090A, COF-4090A	477132C1
89422GSK	Front	Paystar - 5000 Series - 5010, F-5010, F-5050, F-5050SF, 5070, F-5070, F-5070SF	477132C1
89422GSK	Front	TranStar - Conventional - 4170, F-4170, 4200, F-4200, 4300 & F-4300	477132C1
89424GSK	Front	Series 400, 500, 600, 700, & 900 - Medium Cabover Truck & Tractor (Nissan) - 600, 700, 900 Series	56101 Z1030
89424GSK	Front	Series 400, 500, 600, 700, & 900 - Medium Cabover Truck & Tractor (Nissan) - 600, 700, 900 Series	56101 Z2000
89426GSK	Front	Series 8000 - Conventional Heavy Duty Tractor - 8100, 8200, 8300 Series w/ 12,000 - 14,000 lb Suspension	1664788C2
89426GSK	Front	Series 9100, 9100i - Tractor & Straight Truck - 9100 Series w/ 12,000 - 14,000 lb Suspension	1664788C2
89426GSK	Front	Series 9200, 9200i - Tractor & Straight Truck - Models w/ 12,000 - 18,000 lb Suspension	1664788C2
89426GSK	Front	Series 9300, 9300i, 9400 & 9400i Long Hood Conventional Truck & Tractor - Models w/ 12,000 - 14,000 lb Suspension	1664788C2
89426GSK	Front	Series 9600 & 9700 Premium Cabover Tractor - 9600, 9700 Series Except Low Profile	1664788C2
89426GSK	Front	Series 9900, 9900i, 9900ix Long Hood Conventional Truck - Models w/ 12,000 - 14,000 lb Suspension	1664788C2
89426GSK	Front	Series 2000 - Conventional Truck (Severe Service) - All 2000 Series - W/out 12,000 lb Front Axle and w/ 16,000/ 18,000 lb Springs	2015556C1
89426GSK	Front	Series 4000 - Short Conventional Medium Truck & Tractor - 4900 Series w/ Dual Doors	2015556C1
89426GSK	Front	Series 8000 - Conventional Heavy Duty Tractor - 8100, 8200, 8300 Series w/ 12,000 - 14,000 lb Suspension	2015556C1
89426GSK	Front	Series 9100, 9100i - Tractor & Straight Truck - 9100 Series w/ 12,000 - 14,000 lb Suspension	2015556C1

Part No.	Front/ Rear	Application & Model Information	OEM Part No.
89426GSK	Front	Series 9200, 9200i - Tractor & Straight Truck - Models w/ 12,000 - 18,000 lb Suspension	2015556C1
89426GSK	Front	Series 9300, 9300i, 9400 & 9400i Long Hood Conventional Truck & Tractor - Models w/ 12,000 - 14,000 lb Suspension	2015556C1
89426GSK	Front	Series 9600 & 9700 Premium Cabover Tractor - 9600, 9700 Series Except Low Profile	2015556C1
89426GSK	Front	Series 9800 - Premium Cabover Tractor - 9800 Series - w/ Set Back axle	2015556C1
89426GSK	Front	Series 9900, 9900i, 9900ix Long Hood Conventional Truck - Models w/ 12,000 - 14,000 lb Suspension	2015556C1
89426GSK	Front	2009 - 2011 - Paystar - 5000 Series - 5900i Models w/ 12,000 - 14,000 lb Front Axle	2015556C1
89426GSK	Front	Series 9100, 9100i - Tractor & Straight Truck - 9100 Series w/ 12,000 - 14,000 lb Suspension	2032533C1
89426GSK	Front	Series 9200, 9200i - Tractor & Straight Truck - Models w/ 12,000 - 18,000 lb Suspension	2032533C1
89426GSK	Front	Series 9300, 9300i, 9400 & 9400i Long Hood Conventional Truck & Tractor - Models w/ 12,000 - 14,000 lb Suspension	2032533C1
89426GSK	Front	Series 9900, 9900i, 9900ix Long Hood Conventional Truck - Models w/ 12,000 - 14,000 lb Suspension	2032533C1
89426GSK	Front	Models w/ OEM Number	3571711C1
89430GSK	Rear	Series 5000, 5000i - Severe Service Conventional Truck & Tractor - 5070 Series - 6 X 4 - w/ Neway AD246-10 Air Suspension and 60" Axle Spacing	2029200C91
89430GSK	Rear	Series 8000 - Conventional Heavy Duty Tractor - 8100, 8200, 8300 Series - 6 X 4 - w/ Neway AD246-10 Air Suspension and 60" Axle Spacing	2029200C91
89430GSK	Rear	Series 9100, 9100i - Tractor & Straight Truck - 9100 Series - 6 X 4 - w/ Neway AD246-10 Air Suspension and 60" Axle Spacing	2029200C91
89430GSK	Rear	Series 9200, 9200i - Tractor & Straight Truck - 6 X 4 Models Neway AD246-10 Air Suspension and 60" Axle Spacing	2029200C91
89430GSK	Rear	Series 9300, 9300i, 9400 & 9400i Long Hood Conventional Truck & Tractor - Models w/ 6 X 4 w/ Neway AD246-10 Air Suspension and 60" Axle Spacing	2029200C91
89430GSK	Rear	Series 9800 - Premium Cabover Tractor - 9800 Series - 6 X 4 Models w/ Neway AD246-10 Air Suspension and 60" Axle Spacing	2029200C91
89430GSK	Rear	Series 9900, 9900i, 9900ix Long Hood Conventional Truck - 6 X 4 Models w/ Neway AD246-10 Air Suspension and 60" Axle Spacing	2029200C91
89430GSK	Rear	2004 - 2009 - Paystar - 5000 Series - 5900i SFA Models w/ 46,000 lb Neway Rear Air Suspension	2029200C91

Part No.	Front/ Rear	Application & Model Information	OEM Part No.
89430GSK	Rear	2004 - 2009 - Paystar - 5000 Series - 5900i SFA Models w/ 46,000 lb Neway Rear Air Suspension	90044626
89430GSK	Rear	Series 8000 - Conventional Heavy Duty Tractor - 8100, 8200, 8300 Series - w/ Hendrickson HA-460 Air Suspension w/ 55" & 60" axle spacing and 40,000/ 46,000 lb capacity	AMS 600102
89430GSK	Rear	Series 8000 - Conventional Heavy Duty Tractor - 8100, 8200, 8300 Series w/ Hendrickson HA-230 Rear Air Suspension	AMS 600102
89430GSK	Rear	Series 9100, 9100i - Tractor & Straight Truck - 9100 Series - w/ Hendrickson HA-460 Series Air Suspension	AMS 600102
89430GSK	Rear	Series 9200, 9200i - Tractor & Straight Truck - Models w/ Hendrickson HA-460 Series Air Suspension	AMS 600102
89430GSK	Rear	Series 9300, 9300i, 9400 & 9400i Long Hood Conventional Truck & Tractor - Models w/ Hendrickson HA-460 Series Air Suspension	AMS 600102
89430GSK	Rear	Series 9600 & 9700 Premium Cabover Tractor - 9600, 9700 Series w/ Hendrickson HA-460 Air Suspension w/ 55" or 60" axle spacing and 40,000/ 46,000 lb capacity	AMS 600102
89430GSK	Rear	Series 9800 - Premium Cabover Tractor - 9800 Series - w/ Hendrickson HA-460 Air Suspension w/ 55" & 60" axle spacing and 40,000/ 46,000 lb capacity	AMS 600102
89430GSK	Rear	Series 9900, 9900i, 9900ix Long Hood Conventional Truck - Models w/ Hendrickson HA-460 Series Air Suspension	AMS 600102
89431GSK	Front	Series 2000 - Conventional Truck (Severe Service) - All 2000 Series - W/out 12,000 lb Front Axle and w/ 16,000/ 18,000 lb Springs	1667520C1
89431GSK	Front	Series 4000 - Short Conventional Medium Truck & Tractor - 4600, 4700, 4800, 4900 Series	1667520C1
89431GSK	Front	Series 8000 - Conventional Heavy Duty Tractor - 8100, 8200, 8300 Series w/ 15,000 - 18,000 lb Suspension	1667520C1
89431GSK	Front	Series 9300, 9300i, 9400 & 9400i Long Hood Conventional Truck & Tractor - Models w/ 16,000 - 18,000 lb Suspension	1667520C1
89431GSK	Front	Series 9600 & 9700 Premium Cabover Tractor - 9600, 9700 Series w/ 16,000 - 18,000 lb Suspension	1667520C1
89431GSK	Front	Series 9900, 9900i, 9900ix Long Hood Conventional Truck - Models w/ 16,000 - 18,000 lb Suspension	1667520C1
89431GSK	Front	2004 - 2011 - Paystar - 5000 Series - 5900 SB Models w/ 18,000 lb Front Axle	1667520C1
89431GSK	Front	2004 - 2011 - Paystar - 5000 Series - 5900i SFA Models w/ 16,000 lb Front Axle	1667520C1
89431GSK	Front	Pre - 2011 - Paystar - 5000 Series - 5600i Models w/ 16,000 lb Front Axle	1667520C1
89440GSK	Front	Series 3000 - School Bus Chassis - 3900FC Series	1677707C1

Part No.	Front/ Rear	Application & Model Information	OEM Part No.
89440GSK	Front	Series 3000 - School Bus Chassis - 3900FC Series	2015557C1
89440GSK	Rear	Series 9300, 9300i, 9400 & 9400i Long Hood Conventional Truck & Tractor - Models w/ w/ Hendrickson RS-460 Rear Air Suspension	2015557C1
89440GSK	Rear	Series 9900, 9900i, 9900ix Long Hood Conventional Truck - Models w/ Hendrickson RS-460 Rear Air Suspension	2015557C1
89440GSK	Front	Series 9300, 9300i, 9400 & 9400i Long Hood Conventional Truck & Tractor - (SFA Model) w/ 16,000 - 18,000 lb Suspension	507202C1
89440GSK	Front	Series 9600 & 9700 Premium Cabover Tractor - 9600, 9700 Series	507202C1
89440GSK	Front	Series 9900, 9900i, 9900ix Long Hood Conventional Truck - (SFA Model) w/ 16,000 - 18,000 lb Suspension	507202C1
89440GSK	Rear	Series 5000, 5000i - Severe Service Conventional Truck & Tractor - 5070 Series - 6 X 4 - w/ Neway AD246-10 Air Suspension and 60" Axle Spacing	AMS 600172
89440GSK	Rear	Series 8000 - Conventional Heavy Duty Tractor - 8100, 8200, 8300 Series - 6 X 4 - w/ Neway AD246-10 Air Suspension and 60" Axle Spacing	AMS 600172
89440GSK	Rear	Series 9100, 9100i - Tractor & Straight Truck - 9100 Series - 6 X 4 - w/ Neway AD246-10 Air Suspension and 60" Axle Spacing	AMS 600172
89440GSK	Rear	Series 9200, 9200i - Tractor & Straight Truck - 6 X 4 Models Neway AD246-10 Air Suspension and 60" Axle Spacing	AMS 600172
89440GSK	Rear	Series 9300, 9300i, 9400 & 9400i Long Hood Conventional Truck & Tractor - Models w/ 6 X 4 w/ Neway AD246-10 Air Suspension and 60" Axle Spacing	AMS 600172
89440GSK	Rear	Series 9800 - Premium Cabover Tractor - 9800 Series - 6 X 4 Models w/ Neway AD246-10 Air Suspension and 60" Axle Spacing	AMS 600172
89440GSK	Rear	Series 9900, 9900i, 9900ix Long Hood Conventional Truck - 6 X 4 Models w/ Neway AD246-10 Air Suspension and 60" Axle Spacing	AMS 600172
89446GSK	Front	Cargostar - CO-1610A & B, CO-1630A & B, CO-1710A & B, CO-1730A & B, CO-1750A & B, CO-1810A & B, CO-1830A & B, COF-1810A & B - Excluding vehicles w/ 9,000/ 10,800/ 12,000 lb Front Axle	453572C91
89446GSK	Front	Cargostar - CO-1910A & B, CO-1950A & B, COF-1910A & B, COF-1950A & B	453572C91
89447GSK	Front	F & S Series - 1600, 1700, 1800, 1900, 2100 Series	3000070C91
89447GSK	Front	Series 8000 - Conventional Heavy Duty Tractor - 8100, 8200, 8300 Series	3000070C91
89447GSK	Front	F & S Series - 1624, 1654, 1724, 1754, 1824, 1854, 1924, F1924, 1925, 1954, F1954, 1955, 2124, 2125, F2125, 2154, 2155 Series w/ 9,000/ 10,800/ 12,000 lb Front Axle	472411C91

Part No.	Front/ Rear	Application & Model Information	OEM Part No.
89447GSK	Front	F & S Series - 2275, F2275, 2524, F2524, 2554, F2554, 2574, F2574, 2575, F2575, F2624, F2654, F2674 Series w/ 9,000/ 10,800/ 12,000 lb Front Axle	472411C91
89447GSK	Front	Metro & Multi-Shop Series - M1600, M1700, M1800, M1900, M2100 Series w/ 9,000/ 10,800/ 12,000 lb Front Axle	472411C91
89447GSK	Front	S Series School Bus - 1823, 1853 S Series w/ 9,000/ 10,800/ 12,000 lb Front Axle	472411C91
89447GSK	Front	F & S Series - 1624, 1654, 1724, 1754, 1824, 1854, 1924, F1924, 1925, 1954, F1954, 1955, 2124, 2125, F2125, 2154, 2155 Series w/ 9,000/ 10,800/ 12,000 lb Front Axle	472412C91
89447GSK	Front	F & S Series - 2275, F2275, 2524, F2524, 2554, F2554, 2574, F2574, 2575, F2575, F2624, F2654, F2674 Series w/ 9,000/ 10,800/ 12,000 lb Front Axle	472412C91
89447GSK	Front	Metro & Multi-Shop Series - M1600, M1700, M1800, M1900, M2100 Series w/ Front Axle Codes 02109, 02118, 02309, 02127, 02139, 02329, 02339	472412C91
89447GSK	Front	S Series School Bus - 1823, 1853 S Series w/ 9,000/ 10,800/ 12,000 lb Front Axle	472412C91
89447GSK	Front	Series 1000 Forward Control Chassis - 1452, 1652 Series	472412C91
89447GSK	Front	Series 1000 Forward Control Chassis - M1400, M1600 Series	472412C91
89447GSK	Front	Series 2000 - Conventional Truck (Severe Service) - 2554, 2574, 2654, 2674 Series	472412C91
89447GSK	Front	Series 2000 - Conventional Truck (Severe Service) - All 2000 Series - W/ 12,000 lb Front Axle	472412C91
89447GSK	Front	Series 3000 - School Bus Chassis - 3700, 3800 Series	472412C91
89447GSK	Front	Series 4000 - Short Conventional Medium Truck & Tractor - 4600, 4700, 4800, 4900 Series w/ 10,000 lb Front Axle	472412C91
89447GSK	Front	Series 7000 - Short Conventional Medium Truck & Tractor - 7100 Series	472412C91
89447GSK	Front	Series 8000 - Conventional Heavy Duty Tractor - 8100 Series Car Hauler	472412C91
89447GSK	Front	F & S Series - 1624, 1654, 1724, 1754, 1824, 1854, 1924, F1924, 1925, 1954, F1954, 1955, 2124, 2125, F2125, 2154, 2155 Series w/ 9,000/ 10,800/ 12,000 lb Front Axle	586724C91
89447GSK	Front	F & S Series - 2275, F2275, 2524, F2524, 2554, F2554, 2574, F2574, 2575, F2575, F2624, F2654, F2674 Series w/ 9,000/ 10,800/ 12,000 lb Front Axle	586724C91
89447GSK	Front	Metro & Multi-Shop Series - M1600, M1700, M1800, M1900, M2100 Series w/ Front Axle Codes 02109, 02118, 02309, 02127, 02139, 02329, 02339	586724C91

Part No.	Front/ Rear	Application & Model Information	OEM Part No.
89447GSK	Front	S Series School Bus - 1823, 1853 S Series w/ 9,000/ 10,800/ 12,000 lb Front Axle	586724C91
89447GSK	Front	Series 1000 Forward Control Chassis - 1452, 1652 Series	586724C91
89447GSK	Front	Series 1000 Forward Control Chassis - M1400, M1600 Series	586724C91
89447GSK	Front	Series 3000 - School Bus Chassis - 3700, 3800 Series	586724C91
89447GSK	Front	Series 4000 - Short Conventional Medium Truck & Tractor - 4600, 4700, 4800, 4900 Series	586724C91
89447GSK	Front	Series 7000 - Short Conventional Medium Truck & Tractor - 7100 Series	586724C91
89457GSK	Front	Pre - 2011 - Series 9900, 9900i, 9900ix Long Hood Conventional Truck - Day Cab Models w/ 12,000 lb Front Axles	3581106C1
89457GSK	Front	Pre - 2011 - Series 9900, 9900i, 9900ix Long Hood Conventional Truck - Day Cab Models w/ 12,000 lb Front Axles	3581106C2
89457GSK	Front	Pre - 2011 - Series 9900, 9900i, 9900ix Long Hood Conventional Truck - Day Cab Models w/ 12,000 lb Front Axles	3581106C3
89457GSK	Front	2000 - 2007 - Series 9200, 9200i - Tractor & Straight Truck - Models w/ 12,000 lb Front Axle	3581107C1
89457GSK	Front	2000 - 2007 - Series 9300, 9300i, 9400 & 9400i Long Hood Conventional Truck & Tractor - Models w/ 12,000 lb Front Axle	3581107C1
89457GSK	Front	2000 - 2007 - Series 9200, 9200i - Tractor & Straight Truck - Models w/ 12,000 lb Front Axle	3581107C2
89457GSK	Front	2000 - 2007 - Series 9300, 9300i, 9400 & 9400i Long Hood Conventional Truck & Tractor - Models w/ 12,000 lb Front Axle	3581107C2
89457GSK	Front	2000 - 2007 - Series 9200, 9200i - Tractor & Straight Truck - Models w/ 12,000 lb Front Axle	3581107C3
89457GSK	Front	2000 - 2007 - Series 9300, 9300i, 9400 & 9400i Long Hood Conventional Truck & Tractor - Models w/ 12,000 lb Front Axle	3581107C3
89457GSK	n/a	Additional OEM Interchanges	3581109C1
89457GSK	Front	Series 9200, 9200i - Tractor & Straight Truck - 6 X 4 Models w/ 12,000 - 14,000 lb Front Axles	3581109C3
89457GSK	Front	Series 9200, 9200i - Tractor & Straight Truck - 6 X 4 Models w/ 12,000 - 14,000 lb Front Axles	3581109C4
89457GSK	n/a	Additional OEM Interchanges	3584535C1
89457GSK	Front	2004 - 2009 - Series 9200, 9200i - Tractor & Straight Truck - Models w/ 12,000 lb Front Axle	3584535C3
89457GSK	Front	2004 - 2009 - Series 9300, 9300i, 9400 & 9400i Long Hood Conventional Truck & Tractor - Models w/ 12,000 lb Front Axle	3584535C3
89457GSK	Front	2004 - 2009 - Series 9900, 9900i, 9900ix Long Hood Conventional Truck - Models w/ 12,000 lb Front Axle	3584535C3

Part No.	Front/ Rear	Application & Model Information	OEM Part No.
89458GSK	Rear	2003 - 2010 - TranStar - 8500, 8600 Series - Models w/ 40,000 lb Rear Air Suspension	3549099C1
89458GSK	Rear	2003 - 2010 - TranStar - 8500, 8600 Series - Models w/ 40,000 lb Rear Air Suspension	3549099C2
89458GSK	Rear	Pre - 2009 - DuraStar - 4300, 4400 Series - Models w/ 40,000 lb Rear Air Suspension	3549099C2
89458GSK	Rear	Series 9200, 9200i - Tractor & Straight Truck - Models w/ IAS Suspension w/ 9.25" or 9.5" Ride Height	3573265C1
89458GSK	Rear	Series 9300, 9300i, 9400 & 9400i Long Hood Conventional Truck & Tractor - Models w/ IAS Suspension w/ 9.25" or 9.5" Ride Height	3573265C1
89458GSK	Rear	2004 - 2009 - Series 9200, 9200i - Tractor & Straight Truck - Models w/ 40,000 lb Rear Air Suspension	3586883C1
89458GSK	Rear	2004 - 2009 - Series 9300, 9300i, 9400 & 9400i Long Hood Conventional Truck & Tractor - Models w/ 40,000 lb Rear Air Suspension	3586883C1
89458GSK	Rear	2004 - 2011 - Series 9900, 9900i, 9900ix Long Hood Conventional Truck - Models w/ 40,000 lb Rear Air Suspension	3586883C1
89458GSK	Rear	2009 - 2010 - LoneStar - Series - All models w/ 40,000 lb Rear Air Suspension	3620395C1
89458GSK	Rear	2009 - 2011 - ProStar - Series - All models w/ 40,000 lb Rear Air Suspension	3620395C1

ISUZU

Table 7-111: Suspension & Ride Control - Shock Application: ISUZU

Part No.	Front/ Rear	Application & Model Information	OEM Part No.
89406GSK	Rear	2009 - FVR Series - FVR Models w/ Hendrickson HAS suspension	12474915
89413GSK	Rear	1986 - 1995 - NPR Series - NPR Series (NPC & NPN)	51630666
89413GSK	Rear	Other Series - Models w/ OEM Number	8-51630-666-0
89413GSK	Rear	1985 - Other Series - KS22 Series (All)	9-51630-666-0
89413GSK	Rear	1986 - 1995 - NPR Series - NPR Series (NPC & NPN)	9-51630-666-0
89413GSK	Rear	1989 - 1992 - NPR Series - NPR Series Flatlow	9-51630-666-0
89413GSK	Rear	1985 - Other Series - KS22 Series (All)	9-51630-666-2
89413GSK	Rear	1986 - 1994 - NPR Series - NPR Series (All)	9-51630-666-2

Part No.	Front/ Rear	Application & Model Information	OEM Part No.
89413GSK	Rear	1986 - 1995 - NPR Series - NPR Series (NPC & NPN)	9-51630-666-2
89413GSK	Rear	1989 - 1992 - NPR Series - NPR Series Flatlow	9-51630-666-2

KENWORTH

Table 7-112: Suspension & Ride Control - Shock Application: KENWORTH

Part No.	Front/ Rear	Application & Model Information	OEM Part No.
89405GSK	Rear	K300, T300 - Models w/ Hendrickson Rear Air Suspension	47902-19
89405GSK	Rear	T600, T600A, T600B, T602 - Models w/ Hendrickson Rear Air Suspension	47902-19
89405GSK	Rear	T800, T800B, T800B(8x4), T800SH, T800H, T800W - Models w/ Hendrickson Rear Air Suspension	47902-19
89405GSK	Rear	W900, W900B, W900L, W900S - Models w/ Hendrickson Rear Air Suspension	47902-19
89405GSK	Rear	2010 - 2011 - T270 - Models w/ Hendrickson HAS - 230L Rear Air Suspension	60670-008
89405GSK	Rear	2010 - 2011 - T370 - Models w/ Hendrickson HAS - 230L Rear Air Suspension	60670-008
89407GSK	Rear	T800, T800B, T800B(8x4), T800SH, T800H, T800W - Models w/ Neway Rear Air Suspension	90044089
89409GSK	n/a	Additional OEM Numbers - Additional OEM Interchanges	665092
89409GSK	n/a	Additional OEM Numbers - Additional OEM Interchanges	665118
89409GSK	Front	Additional OEM Numbers - Models w/ OEM Number	665680
89409GSK	Front	K100, K100E, K125 - Models w/ Multi-Leaf Springs on Front Axle	K374-14
89409GSK	Front	K300, T300 - Models w/ Multi-Leaf Springs on Front Axle	K374-14
89409GSK	Front	T2000 - Models w/ Multi-Leaf Springs on Front Axle	K374-14
89409GSK	Front	T400, T400B, T450B - Models w/ Multi-Leaf Springs on Front Axle	K374-14
89409GSK	Front	T600, T600A, T600B, T602 - Models w/ Multi-Leaf Springs on Front Axle	K374-14
89409GSK	Front	T800, T800B, T800B(8x4), T800SH, T800H, T800W - Models w/ Multi-Leaf Springs on Front Axle	K374-14
89409GSK	Front	W900, W900B, W900L, W900S - Models w/ Multi-Leaf Springs on Front Axle	K374-14
89409GSK	Front	Pre - 2009 - C500, C500B, C500K, C540 & C550 - Models w/ Multi-Leaf Springs on Front Axle	K374-14
89409GSK	Front	K100, K100E, K125 - Models w/ Multi-Leaf Springs on Front Axle	K374-3

Part No.	Front/ Rear	Application & Model Information	OEM Part No.
89409GSK	Front	K300, T300 - Models w/ Multi-Leaf Springs on Front Axle	K374-3
89409GSK	Front	T2000 - Models w/ Multi-Leaf Springs on Front Axle	K374-3
89409GSK	Front	T400, T400B, T450B - Models w/ Multi-Leaf Springs on Front Axle	K374-3
89409GSK	Front	T600, T600A, T600B, T602 - Models w/ Multi-Leaf Springs on Front Axle	K374-3
89409GSK	Front	T800, T800B, T800B(8x4), T800SH, T800H, T800W - Models w/ Multi-Leaf Springs on Front Axle	K374-3
89409GSK	Front	W900, W900B, W900L, W900S - Models w/ Multi-Leaf Springs on Front Axle	K374-3
89409GSK	Front	Pre - 2009 - C500, C500B, C500K, C540 & C550 - Models w/ Multi-Leaf Springs on Front Axle	K374-3
89409GSK	Front	Additional OEM Numbers - Additional OEM Interchanges	K374-3-1
89409GSK	Front	K100, K100E, K125 - Models w/ Multi-Leaf Springs on Front Axle	K374-33
89409GSK	Front	K300, T300 - Models w/ Multi-Leaf Springs on Front Axle	K374-33
89409GSK	Front	T2000 - Models w/ Multi-Leaf Springs on Front Axle	K374-33
89409GSK	Front	T400, T400B, T450B - Models w/ Multi-Leaf Springs on Front Axle	K374-33
89409GSK	Front	T600, T600A, T600B, T602 - Models w/ Multi-Leaf Springs on Front Axle	K374-33
89409GSK	Front	T800, T800B, T800B(8x4), T800SH, T800H, T800W - Models w/ Multi-Leaf Springs on Front Axle	K374-33
89409GSK	Front	W900, W900B, W900L, W900S - Models w/ Multi-Leaf Springs on Front Axle	K374-33
89409GSK	Front	Pre - 2009 - C500, C500B, C500K, C540 & C550 - Models w/ Multi-Leaf Springs on Front Axle	K374-33
89409GSK	Front	K100, K100E, K125 - Models w/ Multi-Leaf Springs on Front Axle	K374-5
89409GSK	Front	K300, T300 - Models w/ Multi-Leaf Springs on Front Axle	K374-5
89409GSK	Front	T2000 - Models w/ Multi-Leaf Springs on Front Axle	K374-5
89409GSK	Front	T400, T400B, T450B - Models w/ Multi-Leaf Springs on Front Axle	K374-5
89409GSK	Front	T600, T600A, T600B, T602 - Models w/ Multi-Leaf Springs on Front Axle	K374-5
89409GSK	Front	T800, T800B, T800B(8x4), T800SH, T800H, T800W - Models w/ Multi-Leaf Springs on Front Axle	K374-5
89409GSK	Front	W900, W900B, W900L, W900S - Models w/ Multi-Leaf Springs on Front Axle	K374-5
89409GSK	Front	Pre - 2009 - C500, C500B, C500K, C540 & C550 - Models w/ Multi-Leaf Springs on Front Axle	K374-5
89409GSK	Front	Additional OEM Numbers - Models w/ OEM Number	K374-C31
89410GSK	Front	Additional OEM Numbers - Models w/ OEM Number	665453

Part No.	Front/ Rear	Application & Model Information	OEM Part No.
89410GSK	Front	Additional OEM Numbers - Models w/ OEM Number	665670
89410GSK	Front	Additional OEM Numbers - Models w/ OEM Number	675122
89410GSK	Front	K100, K100E, K125 - Models w/ Taper-Leaf Springs on Front Axle	K374-11
89410GSK	Front	K300, T300 - Models w/ Taper-Leaf Springs on Front Axle	K374-11
89410GSK	Front	T2000 - Models w/ Taper-Leaf Springs on Front Axle	K374-11
89410GSK	Front	T400, T400B, T450B - Models w/ Multi-Leaf Springs on Front Axle	K374-11
89410GSK	Front	T600, T600A, T600B, T602 - Models w/ Taper-Leaf Springs on Front Axle	K374-11
89410GSK	Front	T800, T800B, T800B(8x4), T800SH, T800H, T800W - Models w/ Taper-Leaf Springs on Front Axle	K374-11
89410GSK	Front	W900, W900B, W900L, W900S - Models w/ Taper-Leaf Springs on Front Axle	K374-11
89410GSK	Front	Pre - 2009 - C500, C500B, C500K, C540 & C550 - Models w/ Taper-Leaf Springs on Front Axle	K374-11
89410GSK	Front	K100, K100E, K125 - Models w/ Taper-Leaf Springs on Front Axle	K374-16
89410GSK	Front	K300, T300 - Models w/ Taper-Leaf Springs on Front Axle	K374-16
89410GSK	Front	T2000 - Models w/ Taper-Leaf Springs on Front Axle	K374-16
89410GSK	Front	T400, T400B, T450B - Models w/ Multi-Leaf Springs on Front Axle	K374-16
89410GSK	Front	T600, T600A, T600B, T602 - Models w/ Taper-Leaf Springs on Front Axle	K374-16
89410GSK	Front	T800, T800B, T800B(8x4), T800SH, T800H, T800W - Models w/ Taper-Leaf Springs on Front Axle	K374-16
89410GSK	Front	W900, W900B, W900L, W900S - Models w/ Taper-Leaf Springs on Front Axle	K374-16
89410GSK	Front	Pre - 2009 - C500, C500B, C500K, C540 & C550 - Models w/ Taper-Leaf Springs on Front Axle	K374-16
89410GSK	Front	K100, K100E, K125 - Models w/ Taper-Leaf Springs on Front Axle	K374-26
89410GSK	Front	K300, T300 - Models w/ Taper-Leaf Springs on Front Axle	K374-26
89410GSK	Front	T2000 - Models w/ Taper-Leaf Springs on Front Axle	K374-26
89410GSK	Front	T400, T400B, T450B - Models w/ Multi-Leaf Springs on Front Axle	K374-26
89410GSK	Front	T600, T600A, T600B, T602 - Models w/ Taper-Leaf Springs on Front Axle	K374-26
89410GSK	Front	T800, T800B, T800B(8x4), T800SH, T800H, T800W - Models w/ Taper-Leaf Springs on Front Axle	K374-26
89410GSK	Front	W900, W900B, W900L, W900S - Models w/ Taper-Leaf Springs on Front Axle	K374-26
89410GSK	Front	Pre - 2009 - C500, C500B, C500K, C540 & C550 - Models w/ Taper-Leaf Springs on Front Axle	K374-26

Part No.	Front/ Rear	Application & Model Information	OEM Part No.
89410GSK	Front	K100, K100E, K125 - Models w/ Taper-Leaf Springs on Front Axle	K374-27
89410GSK	Front	K300, T300 - Models w/ Taper-Leaf Springs on Front Axle	K374-27
89410GSK	Front	T2000 - Models w/ Taper-Leaf Springs on Front Axle	K374-27
89410GSK	Front	T400, T400B, T450B - Models w/ Multi-Leaf Springs on Front Axle	K374-27
89410GSK	Front	T600, T600A, T600B, T602 - Models w/ Taper-Leaf Springs on Front Axle	K374-27
89410GSK	Front	T800, T800B, T800B(8x4), T800SH, T800H, T800W - Models w/ Taper-Leaf Springs on Front Axle	K374-27
89410GSK	Front	W900, W900B, W900L, W900S - Models w/ Taper-Leaf Springs on Front Axle	K374-27
89410GSK	Front	Pre - 2009 - C500, C500B, C500K, C540 & C550 - Models w/ Taper-Leaf Springs on Front Axle	K374-27
89412GSK	Front	K300, T300 - K300 COE Medium Duty	665565
89423GSK	Rear	Additional OEM Numbers - Models w/ OEM Number	680476
89423GSK	Rear	Additional OEM Numbers - Models w/ OEM Number	680486
89423GSK	Rear	C500, C500B, C500K, C540 & C550 - All w/ Air Glide 100 Suspension w/ 8 air bags, 4 units required	K374-29
89423GSK	Rear	K100, K100E, K125 - All w/ Air Glide 100 Suspension w/ 8 air bags, 4 units required	K374-29
89423GSK	Rear	K300, T300 - All w/ Air Glide 100 Suspension w/ 8 air bags, 4 units required	K374-29
89423GSK	Rear	T2000 - All w/ Air Glide 100 Suspension w/ 8 air bags, 4 units required	K374-29
89423GSK	Rear	T400, T400B, T450B - All w/ Air Glide 100 Suspension w/ 8 air bags, 4 units required	K374-29
89423GSK	Rear	T600, T600A, T600B, T602 - All w/ Air Glide 100 Suspension w/ 8 air bags, 4 units required	K374-29
89423GSK	Rear	T800, T800B, T800B(8x4), T800SH, T800H, T800W - All w/ Air Glide 100 Suspension w/ 8 air bags, 4 units required	K374-29
89423GSK	Rear	W900, W900B, W900L, W900S - All w/ Air Glide 100 Suspension w/ 8 air bags, 4 units required	K374-29
89423GSK	Rear	C500, C500B, C500K, C540 & C550 - All w/ Air Glide 100 Suspension w/ 8 air bags, 4 units required	K374-32
89423GSK	Rear	K100, K100E, K125 - All w/ Air Glide 100 Suspension w/ 8 air bags, 4 units required	K374-32
89423GSK	Rear	K300, T300 - All w/ Air Glide 100 Suspension w/ 8 air bags, 4 units required	K374-32
89423GSK	Rear	T2000 - All w/ Air Glide 100 Suspension w/ 8 air bags, 4 units required	K374-32
89423GSK	Rear	T400, T400B, T450B - All w/ Air Glide 100 Suspension w/ 8 air bags, 4 units required	K374-32

Part No.	Front/ Rear	Application & Model Information	OEM Part No.
89423GSK	Rear	T600, T600A, T600B, T602 - All w/ Air Glide 100 Suspension w/ 8 air bags, 4 units required	K374-32
89423GSK	Rear	T800, T800B, T800B(8x4), T800SH, T800H, T800W - All w/ Air Glide 100 Suspension w/ 8 air bags, 4 units required	K374-32
89423GSK	Rear	W900, W900B, W900L, W900S - All w/ Air Glide 100 Suspension w/ 8 air bags, 4 units required	K374-32
89423GSK	Rear	C500, C500B, C500K, C540 & C550 - All w/ Air Glide 100 Suspension w/ 8 air bags, 4 units required	K374-7
89423GSK	Rear	K100, K100E, K125 - All w/ Air Glide 100 Suspension w/ 8 air bags, 4 units required	K374-7
89423GSK	Rear	K300, T300 - All w/ Air Glide 100 Suspension w/ 8 air bags, 4 units required	K374-7
89423GSK	Rear	T2000 - All w/ Air Glide 100 Suspension w/ 8 air bags, 4 units required	K374-7
89423GSK	Rear	T400, T400B, T450B - All w/ Air Glide 100 Suspension w/ 8 air bags, 4 units required	K374-7
89423GSK	Rear	T600, T600A, T600B, T602 - All w/ Air Glide 100 Suspension w/ 8 air bags, 4 units required	K374-7
89423GSK	Rear	T800, T800B, T800B(8x4), T800SH, T800H, T800W - All w/ Air Glide 100 Suspension w/ 8 air bags, 4 units required	K374-7
89423GSK	Rear	W900, W900B, W900L, W900S - All w/ Air Glide 100 Suspension w/ 8 air bags, 4 units required	K374-7
89423GSK	Rear	C500, C500B, C500K, C540 & C550 - All w/ Air Glide 100 Suspension w/ 8 air bags, 4 units required	K374-9
89423GSK	Rear	K100, K100E, K125 - All w/ Air Glide 100 Suspension w/ 8 air bags, 4 units required	K374-9
89423GSK	Rear	K300, T300 - All w/ Air Glide 100 Suspension w/ 8 air bags, 4 units required	K374-9
89423GSK	Rear	T2000 - All w/ Air Glide 100 Suspension w/ 8 air bags, 4 units required	K374-9
89423GSK	Rear	T400, T400B, T450B - All w/ Air Glide 100 Suspension w/ 8 air bags, 4 units required	K374-9
89423GSK	Rear	T600, T600A, T600B, T602 - All w/ Air Glide 100 Suspension w/ 8 air bags, 4 units required	K374-9
89423GSK	Rear	T800, T800B, T800B(8x4), T800SH, T800H, T800W - All w/ Air Glide 100 Suspension w/ 8 air bags, 4 units required	K374-9
89423GSK	Rear	W900, W900B, W900L, W900S - All w/ Air Glide 100 Suspension w/ 8 air bags, 4 units required	K374-9
89423GSK	Rear	T400, T400B, T450B - All w/ Air Glide 100 Suspension w/ 8 air bags, 4 units required	K374-C7
89423GSK	Rear	T600, T600A, T600B, T602 - All w/ Air Glide 100 Suspension w/ 8 air bags, 4 units required	K374-C7

Part No.	Front/ Rear	Application & Model Information	OEM Part No.
89423GSK	Rear	T800, T800B, T800B(8x4), T800SH, T800H, T800W - All w/ Air Glide 100 Suspension w/ 8 air bags, 4 units required	K374-C7
89423GSK	Rear	W900, W900B, W900L, W900S - All w/ Air Glide 100 Suspension w/ 8 air bags, 4 units required	K374-C7
89424GSK	Rear	Additional OEM Numbers - Models w/ OEM Number	680586
89425GSK	Rear	Additional OEM Numbers - Models w/ OEM Number	680475
89425GSK	Rear	C500, C500B, C500K, C540 & C550 - Models w/ Dual Steering Front Axle and Torsion Bar Bogey Rear Suspension	K374-28
89425GSK	Rear	K100, K100E, K125 - Models w/ Dual Steering Front Axle and Torsion Bar Bogey Rear Suspension	K374-28
89425GSK	Rear	T400, T400B, T450B - Models w/ Torsion Bar Bogey (2 rear axles) and KW Air Ride Suspension (w/ 4 air bags)	K374-28
89425GSK	Rear	T800, T800B, T800B(8x4), T800SH, T800H, T800W - Models w/ Torsion Bar Bogey (2 rear axles) and KW Air Ride Suspension (w/ 4 air bags)	K374-28
89425GSK	Rear	W900, W900B, W900L, W900S - Models w/ Torsion Bar Bogey (2 rear axles) and KW Air Ride Suspension (w/ 4 air bags)	K374-28
89425GSK	Rear	C500, C500B, C500K, C540 & C550 - Models w/ Dual Steering Front Axle and Torsion Bar Bogey Rear Suspension	K374-4
89425GSK	Rear	K100, K100E, K125 - Models w/ Dual Steering Front Axle and Torsion Bar Bogey Rear Suspension	K374-4
89425GSK	Rear	T400, T400B, T450B - Models w/ Torsion Bar Bogey (2 rear axles) and KW Air Ride Suspension (w/ 4 air bags)	K374-4
89425GSK	Rear	T800, T800B, T800B(8x4), T800SH, T800H, T800W - Models w/ Torsion Bar Bogey (2 rear axles) and KW Air Ride Suspension (w/ 4 air bags)	K374-4
89425GSK	Rear	W900, W900B, W900L, W900S - Models w/ Torsion Bar Bogey (2 rear axles) and KW Air Ride Suspension (w/ 4 air bags)	K374-4
89436GSK	Rear	Additional OEM Numbers - Models w/ OEM Number	S-20126
89440GSK	Front	K300, T300 - Models w/ Reyco 1209 or 1212 Suspension (Steer Axle)	19495-01
89440GSK	Front	T600, T600A, T600B, T602 - Models w/ Reyco 1209 or 1212 Suspension (Steer Axle)	19495-01
89440GSK	Front	T800, T800B, T800B(8x4), T800SH, T800H, T800W - Models w/ Reyco 1209 or 1212 Suspension (Steer Axle)	19495-01
89440GSK	Front	W900, W900B, W900L, W900S - Models w/ Reyco 1209 or 1212 Suspension (Steer Axle)	19495-01
89451GSK	Rear	Additional OEM Numbers - Models w/ OEM Number	665828
89451GSK	Rear	2011 - T700 Series - Models w/ Air Glide 380 Rear Air Suspension	C71-1002
89451GSK	Rear	2001 - 2011 - T800, T800B, T800B(8x4), T800SH, T800H, T800W - Models w/ Air Glide 380 Suspension - 38,000 lb	C71-1002

Part No.	Front/ Rear	Application & Model Information	OEM Part No.
89451GSK	Rear	2001 - 2011 - W900, W900B, W900L, W900S - Models w/ Air Glide 380 Suspension - 38,000 lb	C71-1002
89451GSK	Rear	2001 & Later - C500, C500B, C500K, C540 & C550 - Models w/ AirGlide 380 Suspension - 38,000 lb	C71-1002
89451GSK	Rear	2002 - 2010 - T2000 - Models w/ Air Glide 380 Rear Air Suspension	C71-1002
89451GSK	Rear	2002 - 2010 - T600, T600A, T600B, T602 - Models w/ Air Glide 380 Rear Air Suspension	C71-1002
89451GSK	Rear	2006 - 2011 - T660 Series - Models w/ AG380 Rear Air Suspension	C71-1002
89451GSK	Rear	2010 - 2011 - T470 - Models w/ AG380 Rear Air Suspension	C71-1002
89455GSK	Rear	2008 - 2011 - T660 Series - Models w/ 40,000 lb Low Air leaf Suspension	C71-1011
89456GSK	Rear	2005 - 2010 - T2000 - Models w/ Air Glide 400 Suspension	671962
89456GSK	Rear	2005 - 2010 - T600, T600A, T600B, T602 - Models w/ Air Glide 400 Suspension	671962
89456GSK	Rear	2005 - 2011 - T800, T800B, T800B(8x4), T800SH, T800H, T800W - Models w/ Air Glide 400 Suspension	671962
89456GSK	Rear	2005 - 2011 - W900, W900B, W900L, W900S - Models w/ Air Glide 400 Suspension	671962
89456GSK	Rear	2005 & Later - Additional OEM Numbers - All w/ Air Glide 400 Suspension	671962
89456GSK	Rear	2010 - 2011 - T470 - Models w/ Air Glide 400 Suspension	671962
89459GSK	Front	2011 - T700 Series - Models w/ 13,000 lb Front Axle	665858
89459GSK	Front	2005 - 2011 - T800, T800B, T800B(8x4), T800SH, T800H, T800W - Models w/ 12,000 and 13,200 lb Front Axle	665858
89459GSK	Front	2005 - 2011 - W900, W900B, W900L, W900S - Models w/ 12,000 and 13,200 lb Front Axle	665858
89459GSK	Front	2006 - 2010 - T2000 - Models w/ 13,000 lb Front Axle	665858
89459GSK	Front	2006 - 2010 - T600, T600A, T600B, T602 - Models w/ 13,000 lb Front Axle	665858
89459GSK	Front	2006 - 2011 - T660 Series - Models w/ 12,000 and 13,200 lb Front Axle	665858
89459GSK	Front	2010 - 2011 - T470 - Models w/ 12,000 - 20,000 lb Taper-Leaf Front Suspension	665858
89460GSK	Front	2010 - 2011 - T270 - Models w/ 8,000 lb Front Axle	B71-6004
89460GSK	Front	2010 - 2011 - T370 - Models w/ 8,000 lb Front Axle	B71-6004
89460GSK	Front	2010 - 2011 - T270 - Models w/ 10,000 - 12,000 lb Front Axle	B71-6005
89460GSK	Front	2010 - 2011 - T370 - Models w/ 10,000 - 12,000 lb Front Axle	B71-6005
89460GSK	Front	2010 - 2011 - T270 - Models w/ 13,200/ 14,600 lb Front Axle	B71-6006
89460GSK	Front	2010 - 2011 - T370 - Models w/ 13,200/ 14,600 lb Front Axle	B71-6006

LODAL, INC.

Table 7-113: Suspension & Ride Control - Shock Application: LODAL, INC.

Part No.	Front/ Rear	Application & Model Information	OEM Part No.
89406GSK	Front	Refuse Truck	9960257

MACK

Table 7-114: Suspension & Ride Control - Shock Application: Mack

Part No.	Front/ Rear	Application & Model Information	OEM Part No.
89405GSK	Front	Mack Additional Series - Models w/ OEM Number	14QK-2100P6
89405GSK	Rear	Mack Additional Series - R, U, RD 600 Series/ MR600 Series w/ Front Taper-Leaf Springs	14QK-366
89405GSK	Front	2002 - 2007 - CV - Series - CV-713 Models w/ 18,000 lb Front Axles	14QK-366
89405GSK	Front	Mack Additional Series - R, RU, RD600 Series-3-1/2" Wide Springs	14QK-366P1
89405GSK	Front	Mack Additional Series - R, U, RD 600 Series/ MR600 Series w/ Front Taper-Leaf Springs	14QK-366P1
89405GSK	Front	Mack Additional Series - Models w/ OEM Number	14QK-366P2
89405GSK	Front	Mack Additional Series - Models w/ OEM Number	14QK-366P3
89405GSK	Rear	MH Series - MH Series w/ Neway ARD-234 Air Suspension	14QK-375M
89405GSK	Rear	RW Series - RW Series w/ Neway ARD-234 Air Suspension	14QK-375M
89405GSK	Front	CL Series - CL600, CL700 Series w/ Multi-Leaf Spring Suspension	14QK-392AM2
89405GSK	Rear	CH Series - CH600 Series w/ Hendrickson Rear Air	14QK-393AM
89405GSK	Rear	CL Series - CL600, CL700 Series w/ Hendrickson Rear Air Suspension	14QK-393AM
89405GSK	Rear	CH Series - CH600 Series w/ Hendrickson Rear Air	47902-9
89405GSK	Rear	CL Series - CL600, CL700 Series w/ Hendrickson Rear Air Suspension	47902-9
89405GSK	Front	Mack Additional Series - Models w/ OEM Number	651103
89406GSK	Front	Mack Additional Series - Models w/ OEM Number	14QK-372M3
89407GSK	Front	Mack Additional Series - Models w/ OEM Number	14QK-1200P4
89407GSK	Front	F Series - FL Series - Western	14QK-143
89407GSK	Front	F Series - FL Series - Western	14QK-2100D-P4
89407GSK	Front	Mack Additional Series - Models w/ OEM Number	14QK-2100P3

Part No.	Front/ Rear	Application & Model Information	OEM Part No.
89407GSK	Front	Mack Additional Series - MB Series	14QK-2100P4
89407GSK	Front	Mack Additional Series - Models w/ OEM Number	14QK-29301P1
89407GSK	Front	Mack Additional Series - Models w/ OEM Number	14QK-29301P2
89407GSK	Front	Mack Additional Series - R, U, RD 600 Series	14QK-29302
89407GSK	n/a	Mack Additional Series - Additional OEM Interchanges	14QK-29302P1
89410GSK	Front	CL Series - CL600, CL700 Series w/ ST34 Suspension	14QK-2113
89410GSK	Front	CH Series - CH600 Series w/ ST34 Suspension	14QK-2113M
89410GSK	Rear	CH Series - Models w/ OEM Number	14QK-2113M
89410GSK	Front	CL Series - CL600, CL700 Series w/ ST34 Suspension	14QK-2113M
89410GSK	Front	Mack Additional Series - RD Series w/ ST34 Suspension	14QK-2113M
89410GSK	Front	Mack Additional Series - Models w/ OEM Number	14QK-2113P3
89410GSK	Front	MH Series - MH Series w/ OEM Number	14QK-2113P5
89410GSK	Front	RW Series - RW Series w/ OEM Number	14QK-2113P5
89410GSK	Front	MH Series - MH Series w/ OEM Number	14QK-2133M
89410GSK	Front	RW Series - RW Series w/ OEM Number	14QK-2133M
89410GSK	Front	MH Series - MH Series w/ OEM Number	14QK-2133M2
89410GSK	Front	RW Series - RW Series w/ OEM Number	14QK-2133M2
89412GSK	Rear	MH Series - MH Series w/ Taper-Leaf Rear Suspension	14QK-2113P4
89412GSK	Rear	RW Series - RW Series w/ Taper-Leaf Rear Suspension	14QK-2113P4
89412GSK	Rear	CH Series - Models w/ OEM Number	14QK-2113P6
89412GSK	Front	Mack Additional Series - Models w/ OEM Number	14QK-2113P6
89414GSK	Front	Mack Additional Series - Models w/ OEM Number	14QK-2100P2
89414GSK	Front	Mack Additional Series - Models w/ OEM Number	14QK-2105
89414GSK	n/a	Mack Additional Series - Additional OEM Interchanges	14QK-366P4
89414GSK	n/a	Mack Additional Series - Additional OEM Interchanges	14QK-372M2
89414GSK	n/a	Mack Additional Series - Additional OEM Interchanges	651151
89420GSK	n/a	Mack Additional Series - Additional OEM Interchanges	5533699
89420GSK	n/a	Mack Additional Series - Additional OEM Interchanges	5554184
89420GSK	n/a	Mack Additional Series - Additional OEM Interchanges	70042
89422GSK	n/a	Mack Additional Series - Additional OEM Interchanges	14QK-20001P2
89422GSK	Front	Mack Additional Series - Models w/ OEM Number	14QK-29001P2
89430GSK	Front	CH Series - CH600 Series w/ 12,000 lb Taper-Leaf Spring	14QK-392AM
89430GSK	Front	CL Series - CL600, CL700 Series w/ Steering Axle & Taper-Leaf Spring	14QK-392AM
89430GSK	Front/ Rear	MH Series - MH Series w/ OEM Number	14QK-392AM

Part No.	Front/ Rear	Application & Model Information	OEM Part No.
89430GSK	Front/ Rear	RW Series - RW Series w/ OEM Number	14QK-392AM
89430GSK	Front	Mack Additional Series - Models w/ 12,000 lb Taper-Leaf Spring	14QK-392AM3
89430GSK	Front	CH Series - CH600 Series w/ 12,000 lb Taper-Leaf Spring	14QK-392BM
89430GSK	Front	CL Series - CL600, CL700 Series w/ Steering Axle & Taper-Leaf Spring	14QK-392BM
89430GSK	Front	CH Series - CH600 Series w/ 12,000 lb Taper-Leaf Spring	14QK-392BM3
89430GSK	Front	CX Series - Vision - Models w/ 12,000 lb Front Taper-Leaf Suspension	14QK-392BM3
89430GSK	n/a	Mack Additional Series - Additional OEM Interchanges	14QK-392M
89430GSK	Front	CH Series - CH600 Series w/ Steering Axle w/ Parabolic Taper-Leaf Spring	14QK-396
89430GSK	Rear	CH Series - CH600 Series w/ 12,000 lb Taper-Leaf Spring	14QK-396M
89436GSK	Front	Mack Additional Series - Models w/ OEM Number	14QK-2108
89448GSK	Rear	CX Series - Vision - CX Vison Series w/ MACK Air Suspension	14QK-3101M
89448GSK	Rear	CX Series - Vision - CX Vison Series w/ MACK Air Suspension	SDA471700000431
89450GSK	Front	CX Series - Vision - Models w/ OEM Number	141700000373
89450GSK	Rear	2008 - 2010 - CXU - Pinnacle Series - CXU-613 Models w/ 40,000 lb Rear Air Suspensions	14QK-2136M
89450GSK	Front	Pre- 2007 - CHN - Series - CHN-613 Models w/ 12,000 lb Front Axles	14QK-3107M
89450GSK	Front	2008 - 2010 - CXU - Pinnacle Series - CXU-613 Models w/ 12,000 lb Front Axles	14QK-3114M
89450GSK	Rear	CX Series - Vision - CX Vision Series w/ Hendrickson Air Suspension	14QK-431M
89450GSK	Rear	CX Series - Vision - CX Vision Series w/ Parabolic Spring	14QK-431M
89450GSK	Front	CX Series - Vision - Models w/ OEM Number	20513881
89450GSK	Rear	2008 - 2010 - CXU - Pinnacle Series - CXU-613 Models w/ 40,000 lb Rear Air Suspensions	20897198
89450GSK	Front	2008 - 2010 - CXU - Pinnacle Series - CXU-613 Models w/ 12,000 lb Front Axles	20973993
89450GSK	Front	Pre- 2007 - CHN - Series - CHN-613 Models w/ 12,000 lb Front Axles	20973993
89450GSK	Rear	2008 - 2010 - CXU - Pinnacle Series - CXU-613 Models w/ 40,000 lb Rear Air Suspensions	471700002626
89450GSK	Front	2008 - 2010 - CXU - Pinnacle Series - CXU-613 Models w/ 12,000 lb Front Axles	SDA14170000380
89454GSK	Front	Mack Additional Series - Models w/ Hendrickson AirTek Front Air Suspension	14QK-422M
89454GSK	Front	Mack Additional Series - Models w/ Hendrickson AirTek Front Air Suspension	64838-002

MAECO

Table 7-115: Suspension & Ride Control - Shock Application: MAECO

Part No.	Front/ Rear	Application & Model Information	OEM Part No.
89432GSK	n/a	Additional OEM Interchanges	70317
89401GSK	n/a	Additional OEM Interchanges	70127
89401GSK	n/a	Additional OEM Interchanges	70128
89406GSK	n/a	Additional OEM Interchanges	6025
89407GSK	n/a	Additional OEM Interchanges	12866
89410GSK	n/a	Additional OEM Interchanges	70312
89414GSK	n/a	Additional OEM Interchanges	70663
89420GSK	n/a	Additional OEM Interchanges	70034
89420GSK	n/a	Additional OEM Interchanges	70042
89420GSK	n/a	Additional OEM Interchanges	70163
89422GSK	n/a	Additional OEM Interchanges	70018
89422GSK	n/a	Additional OEM Interchanges	70021
89422GSK	n/a	Additional OEM Interchanges	70029
89422GSK	n/a	Additional OEM Interchanges	70039
89422GSK	n/a	Additional OEM Interchanges	74039
89425GSK	n/a	Additional OEM Interchanges	70331
89426GSK	n/a	Additional OEM Interchanges	70334
89429GSK	n/a	Additional OEM Interchanges	70300
89440GSK	Front/ Rear	Models w/ OEM Number	1668722
89440GSK	n/a	Additional OEM Interchanges	70652

MARMON

Table 7-116: Suspension & Ride Control - Shock Application: MARMON

Part No.	Front/ Rear	Application & Model Information	OEM Part No.
89405GSK	Rear	Models w/ OEM Number	51-163-7
89406GSK	Front	Models w/ OEM Number	37-1-1
89406GSK	Rear	Models w/ OEM Number	576451
89411GSK	Rear	Models w/ OEM Number	51-139-28

MATSON SCHOOL BUS

Table 7-117: Suspension & Ride Control - Shock Application: MATSON SCHOOL BUS

Part No.	Front/ Rear	Application & Model Information	OEM Part No.
89422GSK	Front	Models w/ OEM Number	5392387

MITSUBISHI-FUSO

Table 7-118: Suspension & Ride Control - Shock Application: MITSUBISHI-FUSO

Part No.	Front/ Rear	Application & Model Information	OEM Part No.
89447GSK	Front	November 1985 - May 1988 - FM Series - FM555	MC813135

MOHAWK

Table 7-119: Suspension & Ride Control - Shock Application: MOHAWK

Part No.	Front/ Rear	Application & Model Information	OEM Part No.
89407GSK	n/a	Additional OEM Interchanges	MM-6886
89422GSK	n/a	Additional OEM Interchanges	01-0100-905
89422GSK	n/a	Additional OEM Interchanges	MM-74029
89436GSK	n/a	Additional OEM Interchanges	020273544

MOTOR COACH INDUSTRIES

Table 7-120: Suspension & Ride Control - Shock Application: MOTOR COACH INDUSTRIES

Part No.	Front/ Rear	Application & Model Information	OEM Part No.
89420GSK	Rear	Models w/ OEM Number	T14-1048
89422GSK	Front/ Rear	Models w/ OEM Number	12T-1-13

Part No.	Front/ Rear	Application & Model Information	OEM Part No.
89422GSK	Front/ Rear	Models w/ OEM Number	12TA-01-013

MUNCIE RECLAMATION

Table 7-121: Suspension & Ride Control - Shock Application: MUNCIE RECLAMATION

Part No.	Front/ Rear	Application & Model Information	OEM Part No.
89419GSK	n/a	Additional OEM Interchanges	MR1763
89447GSK	n/a	Additional OEM Interchanges	MR3306

NATIONAL COACH CORP

Table 7-122: Suspension & Ride Control - Shock Application: NATIONAL COACH CORP

Part No.	Front/ Rear	Application & Model Information	OEM Part No.
89407GSK	Front	Eldorado Coach RE-29	C800853

NEOPLAN BUS

Table 7-123: Suspension & Ride Control - Shock Application: NEOPLAN BUS

Part No.	Front/ Rear	Application & Model Information	OEM Part No.
89447GSK	Front/ Rear	Models 40	25-1700-101-426
89447GSK	Front/ Rear	Models w/ OEM Number	680307
89447GSK	Front/ Rear	Models w/ OEM Number	AA1002002
89447GSK	Front/ Rear	Models w/ OEM Number	AA1002003

Part No.	Front/ Rear	Application & Model Information	OEM Part No.
89447GSK	Front/ Rear	Models w/ OEM Number	AA1802002
89447GSK	Front/ Rear	Models w/ OEM Number	AC1002002
89447GSK	Front/ Rear	Models w/ OEM Number	AC1002003
89447GSK	n/a	Additional OEM Interchanges	CI 1002003
89447GSK	Front/ Rear	Models 80B	CL1002003
89447GSK	Front/ Rear	Models w/ OEM Number	DT1802002
89447GSK	Front/ Rear	Models 80B	DZ1002002
89447GSK	Front/ Rear	Models w/ OEM Number	GJ1002003
89447GSK	Front/ Rear	Models w/ OEM Number	MM1002002
89447GSK	Front/ Rear	Models w/ OEM Number	MM1002003

ORION BUS INDUSTRIES

Table 7-124: Suspension & Ride Control - Shock Application: ORION BUS INDUSTRIES

Part No.	Front/ Rear	Application & Model Information	OEM Part No.
89422GSK	Rear	Orion I	010234503-4
89422GSK	Rear	Orion II	010234503-4
89422GSK	n/a	Additional OEM Interchanges	680091
89436GSK	Front	Orion II	020273541
89436GSK	Front	Additional OEM Interchanges	020273541-4
89436GSK	Front	Orion II	020273544

OSHKOSH MOTORS

Table 7-125: Suspension & Ride Control - Shock Application: OSHKOSH MOTORS

Part No.	Front/ Rear	Application & Model Information	OEM Part No.
89422GSK	Front	Models w/ OEM Number	12405F-1
89406GSK	n/a	Additional OEM Interchanges	26228-A
89406GSK	Front	Additional OEM Interchanges	665060
89407GSK	n/a	Additional OEM Interchanges	1573270
89409GSK	n/a	Additional OEM Interchanges	40-0242
89419GSK	n/a	Additional OEM Interchanges	1445910
89422GSK	n/a	Additional OEM Interchanges	12405FX1
89422GSK	n/a	Additional OEM Interchanges	2173340
89422GSK	Front	Models w/ OEM Number	5353054
89422GSK	Front	Models w/ OEM Number	665040
89422GSK	Front	Models w/ OEM Number	690049
89426GSK	n/a	Additional OEM Interchanges	40-4951
89431GSK	n/a	Additional OEM Interchanges	40-5348
89440GSK	n/a	Additional OEM Interchanges	40-6967

OSTERLUND TRUCK

Table 7-126: Suspension & Ride Control - Shock Application: OSTERLUND TRUCK

Part No.	Front/ Rear	Application & Model Information	OEM Part No.
89419GSK	Front	Models w/ OEM Number	680117

OTTAWA TRUCK

Table 7-127: Suspension & Ride Control - Shock Application: OTTAWA TRUCK

Part No.	Front/ Rear	Application & Model Information	OEM Part No.
89419GSK	n/a	Additional OEM Interchanges	53540451
89419GSK	Front	Models w/ OEM Number	680117

Part No.	Front/ Rear	Application & Model Information	OEM Part No.
89422GSK	n/a	Additional OEM Interchanges	9007342
89423GSK	n/a	Additional OEM Interchanges	90013787

PACIFIC TRUCK & TRAILER

Table 7-128: Suspension & Ride Control - Shock Application: PACIFIC TRUCK & TRAILER

Part No.	Front/ Rear	Application & Model Information	OEM Part No.
89440GSK	n/a	Additional OEM Interchanges	507202CI

PAGE SUSPENSION

Table 7-129: Suspension & Ride Control - Shock Application: PAGE SUSPENSION

Part No.	Front/ Rear	Application & Model Information	OEM Part No.
89436GSK	Rear	Models w/ LM-2000 Series Lift Axle Suspension	1080099
89436GSK	Rear	Models w/ OEM Number	665133

PETERBILT

Table 7-130: Suspension & Ride Control - Shock Application: PETERBILT

Part No.	Front/ Rear	Application & Model Information	OEM Part No.
89405GSK	Front	Additional Applications - Models w/ OEM Number	02-02142
89405GSK	Front	357 Series - Conventional Models w/ Front Air Suspension and w/out Set Back Front Axle	02-02740
89405GSK	Front	362 Series - COE Models w/ 14,600 lb Taper-Leaf Springs and Set Back Front Axle	02-02740

Part No.	Front/ Rear	Application & Model Information	OEM Part No.
89405GSK	Front	375 Series - Conventional Models w/ Front Air Suspension and w/out Set Back Front Axle	02-02740
89405GSK	Front	376 Series - Conventional Models w/ Front Air Suspension and w/out Set Back Front Axle	02-02740
89405GSK	Front	377 Series - Conventional Models w/ Front Air Suspension and w/out Set Back Front Axle	02-02740
89405GSK	Front	378 Series - Conventional Models w/ Front Air Suspension and w/out Set Back Front Axle	02-02740
89405GSK	Front	379 Series - Conventional Models w/ Front Air Suspension and w/out Set Back Front Axle	02-02740
89405GSK	Front	2006 & Later - 386 Series - Conventional Models w/ Front Air Suspension and w/out Set Back Front Axle	02-02740
89405GSK	Front	2008 & Later - 388 Series - Conventional Models w/ Front Air Suspension and w/out Set Back Front Axle	02-02740
89405GSK	Front	2008 & Later - 389 Series - Conventional Models w/ Front Air Suspension and w/out Set Back Front Axle	02-02740
89405GSK	Front	Pre - 2009 - 387 Series - Conventional Models w/ Front Air Suspension and w/out Set Back Front Axle	02-02740
89405GSK	Front	Additional Applications - Models w/ OEM Number	665658
89408GSK	Front	320 Series - 320 Models w/ Split Progressive Springs	02-01787
89408GSK	Front	Additional Applications - Models w/ OEM Number	02-01787
89408GSK	Front	320 Series - 320 Models w/ Split Progressive Springs	02-02737
89408GSK	Front	357 Series - Conventional Models w/ Spring Suspension and w/out Set Back Front Axle	02-02737
89408GSK	Front	375 Series - Conventional Models w/ Spring Suspension and w/out Set Back Front Axle	02-02737
89408GSK	Front	376 Series - Conventional Models w/ Spring Suspension and w/out Set Back Front Axle	02-02737
89408GSK	Front	377 Series - Conventional Models w/ Spring Suspension and w/out Set Back Front Axle	02-02737
89408GSK	Front	378 Series - Conventional Models w/ Spring Suspension and w/out Set Back Front Axle	02-02737
89408GSK	Front	379 Series - Conventional Models w/ Spring Suspension and w/out Set Back Front Axle	02-02737
89408GSK	Front	2006 & Later - 386 Series - Conventional Models w/ Spring Suspension and w/out Set Back Front Axle	02-02737
89408GSK	Front	2010 & Later - 382 Series - Models w/ 12,000 lb to 14,600 lb Taper-Leaf Spring Suspension	02-02737

Part No.	Front/ Rear	Application & Model Information	OEM Part No.
89408GSK	Front	2010 & Later - 384 Series - Models w/ 12,000 lb to 14,600 lb Taper-Leaf Spring Suspension and Set Forward Front Axle	02-02737
89408GSK	Front	2010 & Later - 587 Series - Models w/ 12,000 lb to 14,600 lb Taper-Leaf Spring Suspension	02-02737
89408GSK	Front	Pre - 2009 - 385 Series - Conventional Models w/ Spring Suspension and w/out Set Back Front Axle	02-02737
89408GSK	Front	Pre - 2009 - 387 Series - Conventional Models w/ Spring Suspension and w/out Set Back Front Axle	02-02737
89408GSK	Front	357 Series - Conventional Models w/ Spring Suspension and w/out Set Back Front Axle	02-02742
89408GSK	Front	375 Series - Conventional Models w/ Spring Suspension and w/out Set Back Front Axle	02-02742
89408GSK	Front	376 Series - Conventional Models w/ Spring Suspension and w/out Set Back Front Axle	02-02742
89408GSK	Front	377 Series - Conventional Models w/ Spring Suspension and w/out Set Back Front Axle	02-02742
89408GSK	Front	378 Series - Conventional Models w/ Spring Suspension and w/out Set Back Front Axle	02-02742
89408GSK	Front	379 Series - Conventional Models w/ Spring Suspension and w/out Set Back Front Axle	02-02742
89408GSK	Front	2006 & Later - 386 Series - Conventional Models w/ Spring Suspension and w/out Set Back Front Axle	02-02742
89408GSK	Front	2008 - 2010 - 365 Series - Models w/ 18,000 - 23,000 lb Taper-Leaf Front Spring Suspension	02-02742
89408GSK	Front	2008 - 2010 - 367 Series - Models w/ 18,000 lb to 23,000 lb Taper-Leaf Front Spring Suspension -	02-02742
89408GSK	Front	2008 & Later - 388 Series - Conventional Models w/ Spring Suspension and w/out Set Back Front Axle	02-02742
89408GSK	Front	2008 & Later - 389 Series - Conventional Models w/ Spring Suspension and w/out Set Back Front Axle	02-02742
89408GSK	Front	Pre - 2009 - 385 Series - Conventional Models w/ Spring Suspension and w/out Set Back Front Axle	02-02742
89408GSK	Front	Pre - 2009 - 387 Series - Conventional Models w/ Spring Suspension and w/out Set Back Front Axle	02-02742
89408GSK	Front	Additional Applications - Models w/ OEM Number	665655
89413GSK	Front	Additional Applications - Models w/ OEM Number	02-01890
89413GSK	Front	Additional Applications - Models w/ OEM Number	02-02225
89413GSK	Front	330 Series - Models w/ 12,000 lb Set Back Front Axle	02-02738

Part No.	Front/ Rear	Application & Model Information	OEM Part No.
89413GSK	Front	357 Series - Conventional Models w/ Spring Suspension and w/ Set Back Front Axle	02-02738
89413GSK	Front	362 Series - COE Models w/ Progressive Springs	02-02738
89413GSK	Front	372 Series - COE Models w/ Front Spring Suspension	02-02738
89413GSK	Front	375 Series - Conventional Models w/ Spring Suspension and w/ Set Back Front Axle	02-02738
89413GSK	Front	376 Series - Conventional Models w/ Spring Suspension and w/ Set Back Front Axle	02-02738
89413GSK	Front	377 Series - Conventional Models w/ Spring Suspension and w/ Set Back Front Axle	02-02738
89413GSK	Front	378 Series - Conventional Models w/ Spring Suspension and w/ Set Back Front Axle	02-02738
89413GSK	Front	379 Series - Conventional Models w/ Spring Suspension and w/ Set Back Front Axle	02-02738
89413GSK	Front	2004 - 2010 - 335 Series - Models w/ 12,000 lb Set Back Front Axle	02-02738
89413GSK	Front	2006 & Later - 386 Series - Conventional Models w/ Spring Suspension and w/ Set Back Front Axle	02-02738
89413GSK	Front	2007 - 2010 - 340 Series - Models w/ 12,000 lb Set Back Front Axle	02-02738
89413GSK	Front	Pre - 2009 - 385 Series - Conventional Models w/ Spring Suspension and w/ Set Back Front Axle	02-02738
89413GSK	Front	Pre - 2009 - 387 Series - Conventional Models w/ Spring Suspension and w/ Set Back Front Axle	02-02738
89413GSK	Front	357 Series - Conventional Models w/ Spring Suspension and w/ Set Back Front Axle	02-02741
89413GSK	Front	375 Series - Conventional Models w/ Spring Suspension and w/ Set Back Front Axle	02-02741
89413GSK	Front	376 Series - Conventional Models w/ Spring Suspension and w/ Set Back Front Axle	02-02741
89413GSK	Front	377 Series - Conventional Models w/ Spring Suspension and w/ Set Back Front Axle	02-02741
89413GSK	Front	378 Series - Conventional Models w/ Spring Suspension and w/ Set Back Front Axle	02-02741
89413GSK	Front	379 Series - Conventional Models w/ Spring Suspension and w/ Set Back Front Axle	02-02741
89413GSK	Front	2004 - 2010 - 335 Series - Models w/ 12,000 lb Set Back Front Axle	02-02741
89413GSK	Front	2006 & Later - 386 Series - Conventional Models w/ Spring Suspension and w/ Set Back Front Axle	02-02741
89413GSK	Front	2007 - 2010 - 340 Series - Models w/ 12,000 lb Set Back Front Axle	02-02741
89413GSK	Front	Pre - 2009 - 385 Series - Conventional Models w/ Spring Suspension and w/ Set Back Front Axle	02-02741

Part No.	Front/ Rear	Application & Model Information	OEM Part No.
89413GSK	Front	Pre - 2009 - 387 Series - Conventional Models w/ Spring Suspension and w/ Set Back Front Axle	02-02741
89413GSK	Front	2006 & Later - 386 Series - Conventional Models w/ Spring Suspension and w/ Set Back Front Axle	02-04010
89413GSK	Front	2008 & Later - 388 Series - Conventional Models w/ Spring Suspension and w/ Set Back Front Axle	02-04010
89413GSK	Front	2008 & Later - 389 Series - Conventional Models w/ Spring Suspension and w/ Set Back Front Axle	02-04010
89413GSK	Front	Pre - 2009 - 387 Series - Conventional Models w/ Spring Suspension and w/ Set Back Front Axle	02-04010
89413GSK	Front	Additional Applications - Models w/ OEM Number	23-12262
89413GSK	Front	Additional Applications - Models w/ OEM Number	665656
89413GSK	Front	Additional Applications - Models w/ OEM Number	665662
89413GSK	Front	Additional Applications - Models w/ OEM Number	665762
89413GSK	Front	Additional Applications - Models w/ OEM Number	671092
89413GSK	Front	Additional Applications - Models w/ OEM Number	680348
89413GSK	Front	Additional Applications - Models w/ OEM Number	B71-6002
89413GSK	Front	2008 - 2010 - 365 Series - Models w/ 12,000 - 16,000 lb Taper-Leaf Front Spring Suspension	B71-6002
89413GSK	Front	2008 - 2010 - 367 Series - Models w/ 10,000 lb to 16,000 lb Taper-Leaf Front Spring Suspension -	B71-6002
89414GSK	Front	Additional Applications - Models w/ OEM Number	02-02061
89414GSK	Front	357 Series - Conventional Models w/ Front Air Suspension and Set Back Front Axle	02-02739
89414GSK	Front	372 Series - COE Models w/ Front Air Suspension	02-02739
89414GSK	Front	375 Series - Conventional Models w/ Front Air Suspension and Set Back Front Axle	02-02739
89414GSK	Front	376 Series - Conventional Models w/ Front Air Suspension and Set Back Front Axle	02-02739
89414GSK	Front	377 Series - Conventional Models w/ Front Air Suspension and Set Back Front Axle	02-02739
89414GSK	Front	378 Series - Conventional Models w/ Front Air Suspension and Set Back Front Axle	02-02739
89414GSK	Front	379 Series - Conventional Models w/ Front Air Suspension and Set Back Front Axle	02-02739
89414GSK	Front	2006 & Later - 386 Series - Conventional Models w/ Front Air Suspension and Set Back Front Axle	02-02739
89414GSK	n/a	2008 & Later - 388 Series - Conventional Models w/ Front Air Suspension and Set Back Front Axle	02-02739

Part No.	Front/ Rear	Application & Model Information	OEM Part No.
89414GSK	n/a	2008 & Later - 389 Series - Conventional Models w/ Front Air Suspension and Set Back Front Axle	02-02739
89414GSK	n/a	Pre - 2009 - 387 Series - Conventional Models w/ Front Air Suspension and w/ Set Back Front Axle	02-02739
89414GSK	Rear	2010 & Later - 337 Series - Models w/ Reyco 102AR (Standard) Rear Air Suspension	12887-01
89414GSK	Rear	2010 & Later - 382 Series - Models w/ Reyco 102AR (Standard) Rear Air Suspension	12887-01
89414GSK	Rear	2010 & Later - 587 Series - Models w/ Reyco 102AR (Standard) Rear Air Suspension	12887-01
89414GSK	Rear	2010 & Later - 337 Series - Models w/ Reyco 102AR (Standard) Rear Air Suspension	12887-02
89414GSK	Rear	2010 & Later - 382 Series - Models w/ Reyco 102AR (Standard) Rear Air Suspension	12887-02
89414GSK	Rear	2010 & Later - 587 Series - Models w/ Reyco 102AR (Standard) Rear Air Suspension	12887-02
89414GSK	Front	Additional Applications - Models w/ OEM Number	665657
89420GSK	Front	349 Series - 349 Conventional Models w/ 12,000 lb capacity	02-00376
89420GSK	Front	353 Series - 353 Conventional Models w/ 12,000 lb capacity	02-00376
89420GSK	Front	359 Series - 359 Conventional Models w/ 12,000 lb capacity	02-00376
89420GSK	Front	362 Series - COE Models w/out Set Back Front Axle	02-00376
89420GSK	Front	349 Series - 349 Conventional Models w/ 12,000 lb capacity	02-00495
89420GSK	Front	353 Series - 353 Conventional Models w/ 12,000 lb capacity	02-00495
89420GSK	Front	359 Series - 359 Conventional Models w/ 12,000 lb capacity	02-00495
89420GSK	Front	362 Series - COE Models w/out Set Back Front Axle	02-00495
89420GSK	Front	349 Series - 349 Conventional Models w/ 12,000 lb capacity	02-02736
89420GSK	Front	353 Series - 353 Conventional Models w/ 12,000 lb capacity	02-02736
89420GSK	Front	359 Series - 359 Conventional Models w/ 12,000 lb capacity	02-02736
89420GSK	Front	362 Series - COE Models w/ 12,000 lb capacity	02-02736
89420GSK	Rear	Additional Applications - Models w/ OEM Number	680026
89420GSK	Front	Additional Applications - Models w/ OEM Number	680457
89422GSK	Rear	Additional Applications - Models w/ OEM Number	03-01635
89422GSK	Rear	Pre - November 1982 - 357 Series - Models w/ Air Trac Suspension - 38,000/ 40,000 lb	03-04176
89422GSK	Rear	Pre - November 1982 - 362 Series - Models w/ Air Trac Suspension - 38,000/ 40,000 lb	03-04176
89422GSK	Rear	Pre - November 1982 - 372 Series - Models w/ Air Trac Suspension - 38,000/ 40,000 lb	03-04176

Part No.	Front/ Rear	Application & Model Information	OEM Part No.
89422GSK	Rear	Pre - November 1982 - 375 Series - Models w/ Air Trac Suspension - 38,000/ 40,000 lb	03-04176
89422GSK	Rear	Pre - November 1982 - 376 Series - Models w/ Air Trac Suspension - 38,000/ 40,000 lb	03-04176
89422GSK	Rear	Pre - November 1982 - 377 Series - Models w/ Air Trac Suspension - 38,000/ 40,000 lb	03-04176
89422GSK	Rear	Pre - November 1982 - 378 Series - Models w/ Air Trac Suspension - 38,000/ 40,000 lb	03-04176
89422GSK	Rear	Pre - November 1982 - 379 Series - Models w/ Air Trac Suspension - 38,000/ 40,000 lb	03-04176
89422GSK	Rear	Pre - November 1982 - 385 Series - Models w/ Air Trac Suspension	03-04176
89422GSK	Rear	Additional Applications - Models w/ OEM Number	23-08233
89422GSK	Rear	Additional Applications - Models w/ OEM Number	23-10393
89422GSK	Rear	Additional Applications - Models w/ OEM Number	680027
89422GSK	Rear	Additional Applications - Models w/ OEM Number	680185
89424GSK	Rear	Additional Applications - Models w/ OEM Number	03-04629
89424GSK	Rear	Additional Applications - Models w/ OEM Number	03-07281
89424GSK	Rear	2004 - 2010 - 335 Series - Models w/ Air Trac Suspension - 38,000/ 40,000 lb	03-07421
89424GSK	Rear	2006 & Later - 386 Series - Models w/ Peterbilt Air Leaf Suspension	03-07421
89424GSK	Rear	2007 - 2010 - 340 Series - Models w/ Air Trac Suspension - 38,000/ 40,000 lb	03-07421
89424GSK	Rear	2008 - 2010 - 365 Series - Models w/ Air Trac Suspension - 38,000/ 40,000 lb	03-07421
89424GSK	Rear	2008 - 2010 - 367 Series - Models w/ Air Trac Suspension - 38,000/ 40,000 lb	03-07421
89424GSK	Rear	2008 & Later - 388 Series - Models w/ Peterbilt Air Leaf Suspension	03-07421
89424GSK	Rear	2008 & Later - 389 Series - Models w/ Peterbilt Air Leaf Suspension	03-07421
89424GSK	Rear	2010 & Later - 337 Series - Models w/ Peterbilt Air Trac Suspension - 38,000/ 40,000 lb	03-07421
89424GSK	Rear	2010 & Later - 382 Series - Models w/ Air Trac Suspension - 38,000/ 40,000 lb	03-07421
89424GSK	Rear	2010 & Later - 384 Series - Models w/ Air Trac Suspension - 38,000/ 40,000 lb	03-07421
89424GSK	Rear	2010 & Later - 587 Series - Models w/ Air Trac Suspension - 38,000/ 40,000 lb	03-07421
89424GSK	Rear	November 1982 & Later - 357 Series - Models w/ Air Trac Suspension - 38,000/ 40,000 lb	03-07421

Part No.	Front/ Rear	Application & Model Information	OEM Part No.
89424GSK	Rear	November 1982 & Later - 362 Series - Models w/ Air Trac Suspension - 38,000/ 40,000 lb	03-07421
89424GSK	Rear	November 1982 & Later - 372 Series - Models w/ Air Trac Suspension - 38,000/ 40,000 lb	03-07421
89424GSK	Rear	November 1982 & Later - 375 Series - Models w/ Air Trac Suspension - 38,000/ 40,000 lb	03-07421
89424GSK	Rear	November 1982 & Later - 376 Series - Models w/ Air Trac Suspension - 38,000/ 40,000 lb	03-07421
89424GSK	Rear	November 1982 & Later - 377 Series - Models w/ Air Trac Suspension - 38,000/ 40,000 lb	03-07421
89424GSK	Rear	November 1982 & Later - 378 Series - Models w/ Air Trac Suspension - 38,000/ 40,000 lb	03-07421
89424GSK	Rear	November 1982 & Later - 379 Series - Models w/ Air Trac Suspension - 38,000/ 40,000 lb	03-07421
89424GSK	Rear	November 1982 & Later - 385 Series - Models w/ Air Trac Suspension	03-07421
89424GSK	Rear	Pre - 2009 - 387 Series - Models w/ Peterbilt Air Leaf Suspension	03-07421
89424GSK	Rear	Additional Applications - Models w/ OEM Number	03-07424
89424GSK	Rear	Additional Applications - Models w/ OEM Number	680459
89424GSK	Rear	Additional Applications - Models w/ OEM Number	680586
89427GSK	Rear	Additional Applications - Models w/ OEM Number	03-05106
89427GSK	Rear	Additional Applications - Models w/ OEM Number	03-05384
89427GSK	Rear	Additional Applications - Models w/ OEM Number	03-06084
89427GSK	Rear	2004 - 335 Series - Models w/ Peterbilt Low Air Leaf Suspension	03-07423
89427GSK	Rear	Pre - 2002 - 330 Series - Models w/ Peterbilt 40,000 lb Low Air Leaf Suspension	03-07423
89427GSK	Rear	Pre - 2003 - 357 Series - Models w/ Peterbilt Low Air Leaf Suspension	03-07423
89427GSK	Rear	Pre - 2003 - 362 Series - Models w/ Peterbilt Low Air Leaf Suspension	03-07423
89427GSK	Rear	Pre - 2003 - 372 Series - Models w/ Peterbilt Low Air Leaf Suspension	03-07423
89427GSK	Rear	Pre - 2003 - 375 Series - Models w/ Peterbilt Low Air Leaf Suspension	03-07423
89427GSK	Rear	Pre - 2003 - 376 Series - Models w/ Peterbilt Low Air Leaf Suspension	03-07423
89427GSK	Rear	Pre - 2003 - 377 Series - Models w/ Peterbilt Low Air Leaf Suspension	03-07423
89427GSK	Rear	Pre - 2003 - 378 Series - Models w/ Peterbilt Low Air Leaf Suspension	03-07423
89427GSK	Rear	Pre - 2003 - 379 Series - Models w/ Peterbilt Low Air Leaf Suspension	03-07423
89427GSK	Rear	Pre - 2003 - 385 Series - Models w/ Peterbilt Low Air Leaf Suspension	03-07423
89427GSK	Rear	Pre - 2003 - 387 Series - Models w/ Peterbilt Low Air Leaf Suspension	03-07423
89427GSK	Rear	Pre - 2003 - 357 Series - Models w/ Peterbilt Low Air Leaf Suspension	665633
89427GSK	Rear	Pre - 2003 - 357 Series - Models w/ Peterbilt Low Air Leaf Suspension	665633

Part No.	Front/ Rear	Application & Model Information	OEM Part No.
89427GSK	Rear	Pre - 2003 - 362 Series - Models w/ Peterbilt Low Air Leaf Suspension	665633
89427GSK	Rear	Pre - 2003 - 362 Series - Models w/ Peterbilt Low Air Leaf Suspension	665633
89427GSK	Rear	Pre - 2003 - 372 Series - Models w/ Peterbilt Low Air Leaf Suspension	665633
89427GSK	Rear	Pre - 2003 - 372 Series - Models w/ Peterbilt Low Air Leaf Suspension	665633
89427GSK	Rear	Pre - 2003 - 375 Series - Models w/ Peterbilt Low Air Leaf Suspension	665633
89427GSK	Rear	Pre - 2003 - 375 Series - Models w/ Peterbilt Low Air Leaf Suspension	665633
89427GSK	Rear	Pre - 2003 - 376 Series - Models w/ Peterbilt Low Air Leaf Suspension	665633
89427GSK	Rear	Pre - 2003 - 376 Series - Models w/ Peterbilt Low Air Leaf Suspension	665633
89427GSK	Rear	Pre - 2003 - 377 Series - Models w/ Peterbilt Low Air Leaf Suspension	665633
89427GSK	Rear	Pre - 2003 - 377 Series - Models w/ Peterbilt Low Air Leaf Suspension	665633
89427GSK	Rear	Pre - 2003 - 378 Series - Models w/ Peterbilt Low Air Leaf Suspension	665633
89427GSK	Rear	Pre - 2003 - 378 Series - Models w/ Peterbilt Low Air Leaf Suspension	665633
89427GSK	Rear	Pre - 2003 - 379 Series - Models w/ Peterbilt Low Air Leaf Suspension	665633
89427GSK	Rear	Pre - 2003 - 379 Series - Models w/ Peterbilt Low Air Leaf Suspension	665633
89427GSK	Rear	Pre - 2003 - 385 Series - Models w/ Peterbilt Low Air Leaf Suspension	665633
89427GSK	Rear	Pre - 2003 - 385 Series - Models w/ Peterbilt Low Air Leaf Suspension	665633
89427GSK	Rear	Pre - 2003 - 387 Series - Models w/ Peterbilt Low Air Leaf Suspension	665633
89427GSK	Rear	Pre - 2003 - 387 Series - Models w/ Peterbilt Low Air Leaf Suspension	665633
89427GSK	Rear	Additional Applications - Models w/ OEM Number	665660
89427GSK	Rear	Additional Applications - Models w/ OEM Number	680435
89436GSK	Rear	Additional Applications - Models w/ OEM Number	665133
89451GSK	Rear	Additional Applications - Models w/ OEM Number	665752
89451GSK	Rear	2008 - 2010 - 365 Series - Models w/ FlexAir Suspension - 38,000 lb	C71-1002
89451GSK	Rear	2008 - 2010 - 367 Series - Models w/ FlexAir Suspension - 38,000 lb	C71-1002
89451GSK	Rear	2010 & Later - 382 Series - Models w/ FlexAir Suspension - 38,000 lb	C71-1002
89451GSK	Rear	2010 & Later - 384 Series - Models w/ FlexAir Suspension - 38,000 lb	C71-1002
89451GSK	Rear	2010 & Later - 587 Series - Models w/ FlexAir Suspension - 38,000 lb	C71-1002
89451GSK	Rear	2001 & Later - 378 Series - Models w/ FlexAir Suspension - 38,000 lb	C71-6000
89451GSK	Rear	2001 & Later - 379 Series - Models w/ FlexAir Suspension - 38,000 lb	C71-6000
89451GSK	Rear	2001 & Later - 385 Series - Models w/ FlexAir Suspension - 38,000 lb	C71-6000
89451GSK	Rear	2001 & Later - 387 Series - Models w/ FlexAir Suspension - 38,000 lb	C71-6000
89451GSK	Rear	2006 & Later - 386 Series - Models w/ FlexAir Suspension - 38,000 lb	C71-6000
89451GSK	Rear	2008 - 2010 - 365 Series - Models w/ FlexAir Suspension - 38,000 lb	C71-6000
89451GSK	Rear	2008 - 2010 - 367 Series - Models w/ FlexAir Suspension - 38,000 lb	C71-6000
89451GSK	Rear	2008 & Later - 388 Series - Models w/ FlexAir Suspension - 38,000 lb	C71-6000

Part No.	Front/ Rear	Application & Model Information	OEM Part No.
89451GSK	Rear	2008 & Later - 389 Series - Models w/ FlexAir Suspension - 38,000 lb	C71-6000
89451GSK	Rear	2010 & Later - 382 Series - Models w/ FlexAir Suspension - 38,000 lb	C71-6000
89451GSK	Rear	2010 & Later - 384 Series - Models w/ FlexAir Suspension - 38,000 lb	C71-6000
89451GSK	Rear	2010 & Later - 587 Series - Models w/ FlexAir Suspension - 38,000 lb	C71-6000
89455GSK	Rear	2003 & Later - 330 Series - Models w/ Peterbilt 40,000 lb Low Air Leaf Suspension	03-08781
89455GSK	Rear	2003 & Later - 357 Series - Models w/ Peterbilt Low Air Leaf Suspension	03-08781
89455GSK	Rear	2003 & Later - 362 Series - Models w/ Peterbilt Low Air Leaf Suspension	03-08781
89455GSK	Rear	2003 & Later - 372 Series - Models w/ Peterbilt Low Air Leaf Suspension	03-08781
89455GSK	Rear	2003 & Later - 375 Series - Models w/ Peterbilt Low Air Leaf Suspension	03-08781
89455GSK	Rear	2003 & Later - 376 Series - Models w/ Peterbilt Low Air Leaf Suspension	03-08781
89455GSK	Rear	2003 & Later - 377 Series - Models w/ Peterbilt Low Air Leaf Suspension	03-08781
89455GSK	Rear	2003 & Later - 378 Series - Models w/ Peterbilt Low Air Leaf Suspension	03-08781
89455GSK	Rear	2003 & Later - 379 Series - Models w/ Peterbilt Low Air Leaf Suspension	03-08781
89455GSK	Rear	2003 & Later - 385 Series - Models w/ Peterbilt Low Air Leaf Suspension	03-08781
89455GSK	Rear	2003 & Later - 387 Series - Models w/ Peterbilt Low Air Leaf Suspension	03-08781
89455GSK	Rear	2005 - 2010 - 335 Series - Models w/ Peterbilt Low Air Leaf Suspension	03-08781
89455GSK	Rear	2006 & Later - 386 Series - Models w/ Peterbilt Low Air Leaf Suspension	03-08781
89455GSK	Rear	2008 - 2010 - 365 Series - Models w/ Peterbilt Low Air Leaf Suspension -	03-08781
89455GSK	Rear	2008 - 2010 - 367 Series - Models w/ Peterbilt Low Air Leaf Suspension	03-08781
89455GSK	Rear	2008 & Later - 388 Series - Models w/ Peterbilt Low Air Leaf Suspension	03-08781
89455GSK	Rear	2008 & Later - 389 Series - Models w/ Peterbilt Low Air Leaf Suspension	03-08781

Part No.	Front/ Rear	Application & Model Information	OEM Part No.
89455GSK	Rear	2010 & Later - 337 Series - Models w/ Peterbilt Low Air Leaf Suspension	03-08781
89455GSK	Rear	2010 & Later - 382 Series - Models w/ Peterbilt Low Air Leaf Suspension	03-08781
89455GSK	Rear	2010 & Later - 384 Series - Models w/ Peterbilt Low Air Leaf Suspension	03-08781
89455GSK	Rear	2010 & Later - 587 Series - Models w/ Peterbilt Low Air Leaf Suspension	03-08781
89455GSK	Rear	Additional Applications - Models w/ OEM Number	665826
89455GSK	Rear	Additional Applications - Models w/ OEM Number	671091
89455GSK	Rear	2005 - 2010 - 335 Series - Models w/ Peterbilt Low Air Leaf Suspension	C71-1011
89455GSK	Rear	2008 - 2010 - 365 Series - Models w/ Peterbilt Low Air Leaf Suspension -	C71-1011
89455GSK	Rear	2008 - 2010 - 367 Series - Models w/ Peterbilt Low Air Leaf Suspension	C71-1011
89455GSK	Rear	2008 & Later - 330 Series - Models w/ Peterbilt Low Air Leaf Suspension	C71-1011
89455GSK	Rear	2008 & Later - 386 Series - Models w/ Peterbilt Low Air Leaf Suspension	C71-1011
89455GSK	Rear	2008 & Later - 387 Series - Models w/ Peterbilt Low Air Leaf Suspension	C71-1011
89455GSK	Rear	2008 & Later - 388 Series - Models w/ Peterbilt Low Air Leaf Suspension	C71-1011
89455GSK	Rear	2008 & Later - 389 Series - Models w/ Peterbilt Low Air Leaf Suspension	C71-1011
89455GSK	Rear	2010 & Later - 337 Series - Models w/ Peterbilt Low Air Leaf Suspension	C71-1011
89455GSK	Rear	2010 & Later - 382 Series - Models w/ Peterbilt Low Air Leaf Suspension	C71-1011
89455GSK	Rear	2010 & Later - 384 Series - Models w/ Peterbilt Low Air Leaf Suspension	C71-1011
89455GSK	Rear	2010 & Later - 587 Series - Models w/ Peterbilt Low Air Leaf Suspension	C71-1011
89460GSK	Front	2011 - 337 Series - Models w/ 10,000 - 12,000 lb Front Axle	B71-6005
89460GSK	Front	2011 - 337 Series - Models w/ 10,000 - 12,000 lb Front Axle	B71-6005

PIERCE MANUFACTURING INC.

Table 7-131: Suspension & Ride Control - Shock Application: PIERCE MANUFACTURING INC.

Part No.	Front/ Rear	Application & Model Information	OEM Part No.
89409GSK	n/a	Additional OEM Interchanges	40-0242
89419GSK	n/a	Additional OEM Interchanges	1445910
89426GSK	n/a	Additional OEM Interchanges	40-4951
89431GSK	n/a	Additional OEM Interchanges	40-5348
89440GSK	n/a	Additional OEM Interchanges	40-6967

PREVOST

Table 7-132: Suspension & Ride Control - Shock Application: Prevost

Part No.	Front/ Rear	Application & Model Information	OEM Part No.
89422GSK	n/a	Additional OEM Interchanges	01-0100-905
89422GSK	Front/ Rear	Models w/ OEM Number	12T-1-13
89422GSK	n/a	Additional OEM Interchanges	74939852

REYCO SUSPENSION

Table 7-133: Suspension & Ride Control - Shock Application: REYCO SUSPENSION

Part No.	Front/ Rear	Application & Model Information	OEM Part No.
89405GSK	Front	Drive Axle - 102AR-LM	19623-01
89406GSK	Rear	Trailer - 87 for Great Dane	18164-01
89407GSK	Rear	Trailer - 20 AR/ RS 3162 - Models w/ OEM Number	18163-01
89407GSK	Rear	Trailer - 87 for Great Dane	18163-01
89410GSK	Rear	Trailer - Models w/ OEM Number	17142-01
89411GSK	Front	Steer Axle - 1207	17403-01
89414GSK	Rear	Drive Axle - 102AR (Standard)	12887-01
89414GSK	Rear	Drive Axle - 21AR - 25,000 lb Capacity	12887-01

Part No.	Front/ Rear	Application & Model Information	OEM Part No.
89414GSK	Rear	Drive Axle - 74AR - 30,000 lb Capacity	12887-01
89414GSK	Rear	Drive Axle - 102AR (Standard)	12887-02
89414GSK	Rear	Drive Axle - 21AR - 25,000 lb Capacity	12887-02
89414GSK	Rear	Drive Axle - 74AR - 30,000 lb Capacity	12887-02
89414GSK	Rear	Drive Axle - 79AR	12887-02
89414GSK	Rear	Drive Axle - 102AR (Special)	17146-01
89419GSK	Rear	Trailer - 81LC	12885-01
89419GSK	Rear	Trailer - 87-14, -17 Slider	12885-01
89419GSK	Rear	Trailer - 87-6, 87-9	12885-01
89419GSK	Rear	Trailer - 81C	12885-03
89419GSK	Rear	Trailer - 81S	12885-03
89430GSK	Front	Steer Axle - 1209 (Alternate)	17408-01
89430GSK	Rear	Trailer - Models w/ OEM Number	21497-01
89436GSK	Rear	Trailer - 21B (Special)	18800-01
89436GSK	Front	Trailer - Models w/ OEM Number	700098-01
89440GSK	Rear	Steer Axle - 1209 1212	17358-01
89440GSK	Front	Steer Axle - 1209 1212	19495-01
89440GSK	Rear	Drive Axle - 240AR Air-Ride Suspension - Models w/ OEM Number	20125-01

RIDEWELL CORPORATION

Table 7-134: Suspension & Ride Control - Shock Application: RIDEWELL CORPORATION

Part No.	Front/ Rear	Application & Model Information	OEM Part No.
89407GSK	Rear	Trailer Air-Rides - RAR-210 - W/ Double Convolution Spring	S5878B
89407GSK	Rear	Trailer Air-Rides - RAR-221 Tag Axle	S5878B
89407GSK	Rear	Truck Air-Rides - Models w/ OEM Number	S7172B
89420GSK	Rear	Truck Air-Rides - Models w/ OEM Number	1267395B000
89430GSK	Rear	Trailer Air-Rides - RAR-210 For Trailers w/ 25" Drop	1253069B000
89430GSK	Rear	Trailer Air-Rides - RAR-221AS-11-USW, RAR-221AS-11-1-USW Trailer	1253069B000
89430GSK	Rear	Truck Air-Rides - Models w/ OEM Number	1253069B000
89430GSK	Rear	Truck Air-Rides - RSS-236, RSS-236R Self Steering Tag/Pusher Lift Axle - 13,000/ 16,000 lb Capacity	1253069B000

Part No.	Front/ Rear	Application & Model Information	OEM Part No.
89430GSK	Rear	Trailer Air-Rides - Models w/ OEM Number	1275943B
89430GSK	Front	Trailer Air-Rides - Models w/ OEM Number	57645
89430GSK	Rear	Truck Air-Rides - Models w/ OEM Number	665198
89430GSK	Rear	Trailer Air-Rides - RAR-210 For Trailers w/ 25" Drop	AS30698
89430GSK	Rear	Trailer Air-Rides - RAR-221AS-11-USW, RAR-221AS-11-1-USW Trailer	AS30698
89430GSK	Rear	Truck Air-Rides - RSS-236, RSS-236R Self Steering Tag/Pusher Lift Axle - 13,000/ 16,000 lb Capacity	AS30698
89430GSK	Rear	Trailer Air-Rides - RAR-210 For Trailers w/ 25" Drop	AS3069B
89430GSK	Rear	Trailer Air-Rides - RAR-221AS-11-USW, RAR-221AS-11-1-USW Trailer	AS3069B
89430GSK	Rear	Truck Air-Rides - RSS-236, RSS-236R Self Steering Tag/Pusher Lift Axle - 13,000/ 16,000 lb Capacity	AS3069B
89430GSK	Rear	Truck Air-Rides - Models w/ OEM Number	AS575B
89436GSK	Rear	Truck Air-Rides - Models w/ OEM Number	1250563B000
89436GSK	Rear	Trailer Air-Rides - RAR-240, RAR-240W (Mono Pivot Trailers w/ HD Air Suspension) - Models w/ OEM Number	1270563B000
89436GSK	Rear	Truck Air-Rides - RUA-220B-1-, 7, 7.5, 8, 8.5, 9, 9.5, 10 (Lift Tag Axle & Trailer Lift Suspension)	1270563B000
89436GSK	Rear	Bus and R.V. Air-Rides - Mobile Home & RV w/ Air Suspension	AS563B
89436GSK	Rear	Trailer Air-Rides - RAR-210 Tag Axle	AS563B
89436GSK	Rear	Trailer Air-Rides - RAR-221 Tag Axle	AS563B
89436GSK	Rear	Trailer Air-Rides - RAR-221-11, 12, 13-USW Trailer w/ Shock Absorber and Hanger	AS563B
89436GSK	Rear	Truck Air-Rides - Pusher w/ Axle Lift	AS563B
89436GSK	Rear	Bus and R.V. Air-Rides - Mobile Home & RV w/ Air Suspension	S6009B
89436GSK	Rear	Trailer Air-Rides - RAR-210 Tag Axle	S6009B
89436GSK	Rear	Trailer Air-Rides - RAR-221 Tag Axle	S6009B
89436GSK	Rear	Trailer Air-Rides - RAR-221-11, 12, 13-USW Trailer w/ Shock Absorber and Hanger	S6009B
89436GSK	Rear	Truck Air-Rides - Pusher w/ Axle Lift	S6009B

SAF HOLLAND

Table 7-135: Suspension & Ride Control - Shock Application: SAF HOLLAND

Part No.	Front/ Rear	Application & Model Information	OEM Part No.
89405GSK	Rear	Trailer Air Suspension - AR-80 Series Trailer Air Suspension - (AR-80-6.75)	90044046
89405GSK	Rear	Truck, Bus & Motorhome Air Suspensions - ARD-234 Series Truck & Tractor Air Suspension (ARD-234-6)	90044046
89405GSK	Rear	Truck & Tractor Air Suspension (Tag Axle) - Models w/ OEM Number	AR-2598
89406GSK	Rear	Truck & Tractor Air Suspension (Tag Axle) - Models w/ OEM Number	6025
89406GSK	Rear	Truck & Tractor Air Suspension (Tag Axle) - Models w/ OEM Number	90044679
89406GSK	Rear	Truck & Tractor Air Suspension (Tag Axle) - Models w/ OEM Number	90044683
89406GSK	Rear	Truck & Tractor Air Suspension (Tag Axle) - Models w/ OEM Number	90044688
89407GSK	Rear	Trailer Air Suspension - AR-250 Series Trailer Air Suspension - (AR-250-16, -17)	90044089
89407GSK	Rear	Trailer Air Suspension - AR-90 Series Trailer Air Suspension - (AR-90-14, -15, -16, -17)	90044089
89407GSK	Rear	Trailer Air Suspension - AR-92 Series Trailer Air Suspension - (AR-92-18)	90044089
89407GSK	Rear	Trailer Air Suspension - AR-93 Series Trailer Air Suspension - (AR-93-17)	90044089
89407GSK	Rear	Trailer Air Suspension - RL-228 Series Trailer Air Suspension - (RL-228-17-3)	90044089
89407GSK	Rear	Trailer Air Suspension - RL-230 Series Trailer Air Suspension - (RL-230-16-3, -17-3)	90044089
89407GSK	Rear	Trailer Air Suspension - RL-230 Series Trailer Air Suspension (Single Stud Air Spring) - (RL-230-17-4)	90044089
89407GSK	Rear	Trailer Air Suspension - RL-250 Series Trailer Air Suspension (Std Suspension) - (RL-250-16.0, -17.0)	90044089
89407GSK	Rear	Trailer Air Suspension - RLSA228 Series Trailer Air Suspension (RLSA-228-4217, -4817)	90044089
89407GSK	Rear	Trailer Air Suspension - RLU-228 Series Trailer Air Suspension - (RLU-228-10-3)	90044089
89407GSK	Rear	Truck & Tractor Air Suspension (Tag Axle) - Models w/ OEM Number	90044089C
89407GSK	Rear	Truck & Tractor Air Suspension (Tag Axle) - Models w/ OEM Number	90044684
89407GSK	Rear	Trailer Air Suspension - AR-92 Series Trailer Air Suspension - (AR-92-18)	90044769
89407GSK	Rear	Trailer Air Suspension - AR-93 Series Trailer Air Suspension - (AR-93-17)	90044769
89407GSK	Rear	Truck & Tractor Air Suspension (Tag Axle) - Models w/ OEM Number	90044770

Part No.	Front/ Rear	Application & Model Information	OEM Part No.
89407GSK	Rear	Truck & Tractor Air Suspension (Tag Axle) - Models w/ OEM Number	AR-958
89414GSK	Rear	Truck & Tractor Air Suspension (Tag Axle) - Models w/ OEM Number	57643
89414GSK	Rear	Truck, Bus & Motorhome Air Suspensions - ARD-120 Series Truck & Tractor Air Suspension - (ARD-120-6)	90044025
89414GSK	Rear	Truck, Bus & Motorhome Air Suspensions - ARD-125 Series Truck & Tractor Air Suspension - (ARD-125-6 use on Ford, GM, International (Navistar), Mack, White, Western Star, Freightliner)	90044025
89414GSK	Rear	Truck, Bus & Motorhome Air Suspensions - ARD-238 Series Truck & Tractor Air Suspension (ARD-238-6)	90044025
89414GSK	Rear	Truck, Bus & Motorhome Air Suspensions - ARD-244 Series Truck & Tractor Air Suspension - (ARD-244-6 use on Ford, GM, International (Navistar), Mack, White, Western Star, Freightliner)	90044025
89414GSK	Rear	Truck, Bus & Motorhome Air Suspensions - ARDST-123 Series Truck & Tractor Air Suspension (ARDST-123-6, ARDSTM/L-123-6)	90044025
89414GSK	Rear	Truck, Bus & Motorhome Air Suspensions - ARDST-244 Series Truck & Tractor Air Suspension (ARDST-244-6)	90044025
89414GSK	Rear	Truck, Bus & Motorhome Air Suspensions - ARDST-246 Series Truck & Tractor Air Suspension (ARDST-246-6, ARDSTM/L-246-6)	90044025
89414GSK	Rear	Truck, Bus & Motorhome Air Suspensions - ARDST-250-6 Series Truck & Tractor Air Suspension	90044025
89414GSK	Rear	Truck & Tractor Air Suspension (Tag Axle) - Models w/ OEM Number	90044682
89414GSK	Rear	Truck & Tractor Air Suspension (Tag Axle) - Models w/ OEM Number	AR-1654
89419GSK	Rear	Truck, Bus & Motorhome Air Suspensions - Models w/ OEM Number	665003
89419GSK	Rear	Truck, Bus & Motorhome Air Suspensions - ARD-125 Series Truck & Tractor Air Suspension - (ARD-125-8 use on Mack)	90044016
89419GSK	Rear	Truck, Bus & Motorhome Air Suspensions - ARD-190 Series Truck & Tractor Air Suspension (ARD-190-B)	90044016
89419GSK	Rear	Truck, Bus & Motorhome Air Suspensions - ARD-244 Series Truck & Tractor Air Suspension - (ARD-244-8 use on Mack)	90044016
89419GSK	Rear	Truck & Tractor Air Suspension (Tag Axle) - Models w/ OEM Number	AR-1202
89430GSK	Rear	Truck & Tractor Air Suspension (Tag Axle) - Models w/ OEM Number	90044001
89430GSK	Rear	Trailer Air Suspension - AR-120 Series Trailer Air Suspension - (AR-120, AR-120-L, AR-120-US, AR-120-US-F)	90044626
89430GSK	Rear	Trailer Air Suspension - AR-125 Series Trailer Air Suspension - (AR-125, AR-125-L, AR-125-US, AR-125-US-F)	90044626
89430GSK	Rear	Trailer Air Suspension - AR-165-US Series Trailer Air Suspension (AR165-US)	90044626
89430GSK	Rear	Trailer Air Suspension - AR-70 Series Trailer Air Suspension - (AR-70-9, -14, AR-70A-9, 14)	90044626

Part No.	Front/ Rear	Application & Model Information	OEM Part No.
89430GSK	Rear	Trailer Air Suspension - AR-75 Series Trailer Air Suspension - (AR-75-6, -9, -1-12)	90044626
89430GSK	Rear	Trailer Air Suspension - AR-80 Series Trailer Air Suspension - (AR-80-9-WST)	90044626
89430GSK	Rear	Trailer Air Suspension - RLU-228 Series Trailer Air Suspension - (RLU-228-8-3, RLU-228-9-3)	90044626
89430GSK	Rear	Trailer Air Suspension - RLU-228 Series Trailer Air Suspension (Current Production - w/4" Axle Travel Up) - (RLU-228-9-4, RLU-228-12-4)	90044626
89430GSK	Rear	Truck & Tractor Air Suspension (Tag Axle) - Models w/ OEM Number	AR-134-C
89436GSK	Rear	Truck & Tractor Air Suspension (Tag Axle) - Models w/ OEM Number	57639
89436GSK	Rear	Trailer Air Suspension - Models w/ OEM Number	680268
89436GSK	Rear	Truck, Bus & Motorhome Air Suspensions - ART-500 Series Truck & Tractor Tag Axle Air Suspension - (ART-500-US, ART-500-US-A)	90044008
89436GSK	Rear	Truck & Tractor Air Suspension (Tag Axle) - Models w/ OEM Number	90044071
89436GSK	Rear	Truck & Tractor Air Suspension (Tag Axle) - Models w/ OEM Number	90044081
89436GSK	Rear	Truck & Tractor Air Suspension (Tag Axle) - Models w/ OEM Number	90044086
89436GSK	Rear	Truck & Tractor Air Suspension (Tag Axle) - Models w/ OEM Number	90044095
89436GSK	Rear	Truck & Tractor Air Suspension (Tag Axle) - Models w/ OEM Number	90044981
89436GSK	Rear	Truck & Tractor Air Suspension (Tag Axle) - Models w/ OEM Number	90044982
89436GSK	Rear	Truck & Tractor Air Suspension (Tag Axle) - Models w/ OEM Number	90044991
89436GSK	Rear	Trailer Air Suspension - AR-92 Series Trailer Air Suspension - (AR-92-12)	90044992
89436GSK	Rear	Trailer Air Suspension - Models w/ OEM Number	90045001
89436GSK	Rear	Trailer Air Suspension - Models w/ OEM Number	90045003
89436GSK	Rear	Trailer Air Suspension - NS-400 Series Trailer Air Suspension - (NS-400-17.0)	90045299
89436GSK	Rear	Trailer Air Suspension - NS-450 Series Trailer Air Suspension - (NS-450-17.0)	90045299
89436GSK	Rear	Trailer Air Suspension - RL-230 Series Trailer Air Suspension (Hanger Mounted Shock) - (RL-230-16-4)	90045299
89436GSK	Rear	Trailer Air Suspension - RL-250 Series Trailer Air Suspension (Shock Below Frame) - (RL-250-16-4, -17-4)	90045299
89436GSK	Rear	Truck & Tractor Air Suspension (Tag Axle) - Models w/ OEM Number	AR-1434
89436GSK	Rear	Truck & Tractor Air Suspension (Tag Axle) - Models w/ OEM Number	AR-2451
89436GSK	Rear	Truck & Tractor Air Suspension (Tag Axle) - Models w/ OEM Number	AR-718-C
89436GSK	Rear	Truck & Tractor Air Suspension (Tag Axle) - Models w/ OEM Number	AR-718-C-HD
89436GSK	Rear	Truck & Tractor Air Suspension (Tag Axle) - Models w/ OEM Number	AR-781

SPARTAN MOTORS

Table 7-136: Suspension & Ride Control - Shock Application: SPARTAN MOTORS

Part No.	Front/ Rear	Application & Model Information	OEM Part No.
89414GSK	Rear	1991 - 1995 - K2 / K3/ MountainMaster w/ Tuthill 102 AR Air Suspension	0346-SS5
89414GSK	Rear	1991 - 1995 - K2 / K3/ MountainMaster w/ Tuthill 102 AR Air Suspension	B46-1594

STERLING TRUCK

Table 7-137: Suspension & Ride Control - Shock Application: STERLING TRUCK

Part No.	Front/ Rear	Application & Model Information	OEM Part No.
89401GSK	Front	Models w/ OEM Number	F1HZ-18124-D
89401GSK	Front	Models w/ OEM Number	F1HZ-18124-E
89402GSK	Front	Other Applications - Front Suspension - Models w/ OEM Number	F1HZ-18124-K
89410GSK	Rear	Models w/ OEM Number	F5HZ-18125-B
89414GSK	Rear	1998 - L - Line 8500 Series - Conventional Cab - All w/ Hendrickson HAS Rear Air Suspension	47902-28
89414GSK	Rear	1998 & Later - A - Line 9500 Series (SilverStar) - All Models w/ Hendrickson HAS Rear Air Suspension	47902-28
89414GSK	Rear	1998 & Later - L - Line 9500 Series - Conventional Cab - All w/ Hendrickson HAS Rear Air Suspension	47902-28
89414GSK	Rear	1998 - L - Line 8500 Series - Conventional Cab - All w/ Hendrickson HAS Rear Air Suspension	F6HT-18080-FC
89414GSK	Rear	Models w/ OEM Number	F6HT-18080-FC
89414GSK	Rear	1998 & Later - A - Line 9500 Series (SilverStar) - All Models w/ Hendrickson HAS Rear Air Suspension	F6HT-18080-FC
89414GSK	Rear	1998 & Later - L - Line 9500 Series - Conventional Cab - All w/ Hendrickson HAS Rear Air Suspension	F6HT-18080-FC
89414GSK	Rear	Models w/ OEM Number	F6HZ-18125-D
89425GSK	Rear	Models w/ OEM Number	F5HZ-18125-A
89425GSK	Rear	1998 & Later - A - Line 9500 Series (SilverStar) - All Models w/ 23,000 lb Axle and 52" Taper-Leaf Softride Rear Suspension	F6HT-18080-CA
89425GSK	Rear	1998 & Later - L - Line 8500 Series - Conventional Cab - All Models w/ 23,000 lb Axle and 52" Taper-Leaf Softride Rear Suspension	F6HT-18080-CA

Part No.	Front/ Rear	Application & Model Information	OEM Part No.
89425GSK	Rear	1998 & Later - L - Line 9500 Series - Conventional Cab - All w/ 23,000 lb Axle and 52" Taper-Leaf Softride Rear Suspension	F6HT-18080-CA
89435GSK	Front	1998 & Later - A - Line 9500 Series (SilverStar) - All Models w/ 12,000/ 13,200 lb Axle and 54" Multi-Leaf Spring	F6HT-18045-BC
89435GSK	Front	1998 & Later - L - Line 8500 Series - Conventional Cab - All Models w/ 12,000/ 13,200 lb Axle and 54" Multi-Leaf Spring	F6HT-18045-BC
89435GSK	Front	1998 & Later - L - Line 9500 Series - Conventional Cab - All Models w/ 12,000/ 13,200 lb Axle and 54" Multi-Leaf Spring	F6HT-18045-BC
89438GSK	Front	1998 - Cargo Line - SC-7000 or SC-8000 Series w/ 16,000 lb Multi-Leaf Spring	F6HT-18045-AA
89438GSK	Front	1998 - L - Line 8500 Series - Conventional Cab - LT-8000 Series w/ 16,000 lb Multi-Leaf Spring	F6HT-18045-AA
89438GSK	Front	1998 - L - Line 8500 Series - Conventional Cab - All Models w/ 10,000/ 12,000 lb Axle and 54" Taper-Leaf Spring	F6HT-18045-AC
89438GSK	Front	1998 - L - Line 9500 Series - Conventional Cab - All Models w/ 10,000/ 12,000 lb Axle and 54" Taper-Leaf Spring	F6HT-18045-AC
89438GSK	Front	1998 & Later - A - Line 9500 Series (SilverStar) - All Models w/ 10,000/ 12,000 lb Axle and 54" Taper-Leaf Spring	F6HT-18045-AC
89438GSK	Front	L - Line 8500 Series - Conventional Cab - LT-8501 (101" BBC) Series w/ 8,500/ 9,000 lb Axle and 54" Taper-Leaf Spring	F6HT-18045-HB
89438GSK	Front	1998 & Later - A - Line 9500 Series (SilverStar) - A9513, A9522, AT9513, AT9522 (113" & 122" BBC) Series w/ 8,500/ 9,000 lb Axle and 54" Taper-Leaf Spring	F6HT-18045-HB
89438GSK	Front	1998 & Later - L - Line 9500 Series - Conventional Cab - LT-9501, LT-9511, LT-9513 or LT-9513 (113" & 122" BBC) Series w/ 8,500/ 9,000 lb Axle and 54" Taper-Leaf Spring	F6HT-18045-HB
89438GSK	Front	L - Line 8500 Series - Conventional Cab - LT-8501 (101" BBC) Series w/ 8,500/ 9,000 lb Axle and 54" Taper-Leaf Spring	F6HT-18045-HC
89438GSK	Front	1998 & Later - A - Line 9500 Series (SilverStar) - A9513, A9522, AT9513, AT9522 (113" & 122" BBC) Series w/ 8,500/ 9,000 lb Axle and 54" Taper-Leaf Spring	F6HT-18045-HC
89438GSK	Front	1998 & Later - L - Line 9500 Series - Conventional Cab - LT-9501, LT-9511, LT-9513 or LT-9513 (113" & 122" BBC) Series w/ 8,500/ 9,000 lb Axle and 54" Taper-Leaf Spring	F6HT-18045-HC
89438GSK	Front	Models w/ OEM Number	F6HZ-18124-A
89438GSK	Front	Models w/ OEM Number	F6HZ-18124-G
89438GSK	Front	Models w/ OEM Number	F6HZ-18124-H
89439GSK	Front	1998 & Later - A - Line 9500 Series (SilverStar) - All Models w/ 14,600/ 16,000 lb Axle and 54" Multi-Leaf Spring	F6HT-18045-CC

Part No.	Front/ Rear	Application & Model Information	OEM Part No.
89439GSK	Front	1998 & Later - L - Line 8500 Series - Conventional Cab - All Models w/ 14,600/ 16,000 lb Axle and 54" Multi-Leaf Spring	F6HT-18045-CC
89439GSK	Front	1998 & Later - L - Line 9500 Series - Conventional Cab - All Models w/ 14,600/ 16,000 lb Axle and 54" Multi-Leaf Spring	F6HT-18045-CC
89439GSK	Front	1998 & Later - A - Line 9500 Series (SilverStar) - All Models w/ 12,000/ 13,200/ 14,600 lb Axle and 60" Taper-Leaf Spring	F6HT-18045-EB
89439GSK	Front	1998 & Later - L - Line 8500 Series - Conventional Cab - All Models w/ 12,000 lb/ 13,200/ 14,600 lb Axle and 60" Taper-Leaf Spring -	F6HT-18045-EB
89439GSK	Front	1998 & Later - L - Line 9500 Series - Conventional Cab - All Models w/ 12,000/ 13,200/ 14,600 lb Axle and 60" Taper-Leaf Spring	F6HT-18045-EB
89439GSK	Front	1998 & Later - A - Line 9500 Series (SilverStar) - All Models w/ 12,000/ 13,200/ 14,600 lb Axle and 60" Taper-Leaf Spring	F6HT-18045-EC
89439GSK	Front	1998 & Later - L - Line 8500 Series - Conventional Cab - All Models w/ 12,000 lb/ 13,200/ 14,600 lb Axle and 60" Taper-Leaf Spring -	F6HT-18045-EC
89439GSK	Front	1998 & Later - L - Line 9500 Series - Conventional Cab - All Models w/ 12,000/ 13,200/ 14,600 lb Axle and 60" Taper-Leaf Spring	F6HT-18045-EC
89439GSK	Front	Models w/ OEM Number	F6HZ-18124-C
89439GSK	Front	Models w/ OEM Number	F6HZ-18124-D
89439GSK	Front	Models w/ OEM Number	F6HZ-18124-E
89439GSK	Front	Models w/ OEM Number	F6HZ-18124-F
89440GSK	Front	1998 & Later - A - Line 9500 Series (SilverStar) - All Models w/ 13,200/ 14,600 lb Axle and 54" Taper-Leaf Spring	F6HT-18045-GC
89440GSK	Front	1998 & Later - L - Line 8500 Series - Conventional Cab - All Models w/ 13,200/ 14,600 lb Axle and 54" Taper-Leaf Spring	F6HT-18045-GC
89440GSK	Front	1998 & Later - L - Line 9500 Series - Conventional Cab - All Models w/ 13,200/ 14,600 lb Axle and 54" Taper-Leaf Spring	F6HT-18045-GC
89443GSK	Rear	1999 - 2008 - ACTERRA - Models w/ FAS II Rear Air Suspension	16-15817-000
89443GSK	Rear	1999 & Later - A - Line 9500 Series (SilverStar) - Models w/ FAS II Rear Air Suspension	16-15817-000
89443GSK	Rear	1999 & Later - L - Line 8500 Series - Conventional Cab - Models w/ FAS II Rear Air Suspension	16-15817-000
89443GSK	Rear	2009 - 2010 - ACTERRA - Models w/ FAS II Rear Air Suspension	16-18708-000
89443GSK	Rear	1999 - 2008 - ACTERRA - Models w/ FAS II Rear Air Suspension	680611
89443GSK	Rear	2009 - 2010 - ACTERRA - Models w/ FAS II Rear Air Suspension	SDA471700002809
89443GSK	Rear	Models w/ FAS II Rear Air Suspension	XC45-18080-BA
89446GSK	Front	Models w/ OEM Number	AX267A
89446GSK	Front	Models w/ OEM Number	C4HZ-18124-E
89446GSK	Front	Models w/ OEM Number	E9HZ-18124-A

Part No.	Front/ Rear	Application & Model Information	OEM Part No.
89446GSK	Front	Models w/ OEM Number	F1HZ-18124-A
89453GSK	Front	Pre - April 2009 - ACTERRA - Models w/ Hendrickson Airtek Suspension	58913-003

STOUGHTON TRAILERS INC.

Table 7-138: Suspension & Ride Control - Shock Application: STOUGHTON TRAILERS INC.

Part No.	Front/ Rear	Application & Model Information	OEM Part No.
89436GSK	Rear	Trailers w/ Hendrickson HT190T, HT190U, & HS190T Series Air Suspension	HTA20001
89436GSK	Rear	Trailers w/ Hendrickson HT230T Series Air Suspension	HTA20002

THOMAS SCHOOL BUS

Table 7-139: Suspension & Ride Control - Shock Application: THOMAS SCHOOL BUS

Part No.	Front/ Rear	Application & Model Information	OEM Part No.
89422GSK	Rear	Models w/ OEM Number	61310102
89422GSK	Rear	Models w/ OEM Number	61310103
89431GSK	Front	Models w/ OEM Number	16-19138-000
89436GSK	Rear	Models w/ Neway Tandem Air Suspension	61310232
89437GSK	n/a	Additional OEM Interchanges	6130-0114
89443GSK	Rear	Models w/ FAS II Rear Air Suspension	16-18708-000
89443GSK	Rear	Models w/ FAS II Rear Air Suspension	61310434
89443GSK	Rear	Models w/ FAS II Rear Air Suspension	61310478
89449GSK	Front	Buses w/ 12,000 lb Taper-Leaf Front Suspension	10-13634-000
89449GSK	Front	Models w/ OEM Number	61300224
89449GSK	Front	Models w/ OEM Number	61300240

TRAILMOBILE CANADA CORP.

Table 7-140: Suspension & Ride Control - Shock Application: TRAILMOBILE CANADA CORP.

Part No.	Front/ Rear	Application & Model Information	OEM Part No.
89407GSK	n/a	Additional OEM Interchanges	43-4-239
89407GSK	n/a	Additional OEM Interchanges	43-6-164
89407GSK	Rear	Trailers w/ Hendrickson Air Suspension T23-RL-17	43-8-011
89407GSK	Rear	Trailers w/ Neway Air Suspension AR90-1-14, AR90-1-17	90044089
89407GSK	Rear	Trailers w/ Neway Air Suspension AR90-14, -17	90044089
89407GSK	Rear	Trailers w/ Neway Air Suspension AR93-17	90044089
89414GSK	n/a	Additional OEM Interchanges	43-6-158
89414GSK	Rear	Trailers w/ Reyco Air Suspension Models # 21AR - 25,000 lb Capacity	43-8-002
89414GSK	Rear	Trailers w/ Reyco Air Suspension Models # 74AR - 30,000 lb Capacity	43-8-002
89414GSK	Rear	Trailers w/ Hendrickson Air Suspension T23-US-9 (Lifiable & Non-Lifiable)	43-8-014
89436GSK	n/a	Additional OEM Interchanges	43-4-237
89436GSK	n/a	Additional OEM Interchanges	43-4-277
89436GSK	n/a	Additional OEM Interchanges	43-6-028
89436GSK	Rear	Trailers w/ Hendrickson Air Suspension HT230T - 23,000 lb Capacity	43-6-118
89436GSK	Rear	Trailers w/ Hendrickson Air Suspension T30-US-9, -12, -14, -17	43-8-013
89436GSK	Rear	Trailers w/ Neway Air Suspension AR92-14	90044992

TRANSPORTATION MFG. CORP

Table 7-141: Suspension & Ride Control - Shock Application: TRANSPORTATION MFG. CORP

Part No.	Front/ Rear	Application & Model Information	OEM Part No.
89422GSK	Front/ Rear	City Cruiser	12TA-01-13

TWIN COACH

Table 7-142: Suspension & Ride Control - Shock Application: TWIN COACH

Part No.	Front/ Rear	Application & Model Information	OEM Part No.
89407GSK	Rear	Models w/ OEM Number	90044089
89407GSK	Rear	Models w/ OEM Number	90044089C
89407GSK	Rear	Models w/ OEM Number	AR-958
89436GSK	Rear	Models w/ OEM Number	AR-718-C-HD

VOLVO

Table 7-143: Suspension & Ride Control - Shock Application: Volvo

Part No.	Front/ Rear	Application & Model Information	OEM Part No.
89405GSK	n/a	Additional Volvo PDC Numbers - Additional OEM Interchanges	1091359
89405GSK	n/a	Additional Series - Additional OEM Interchanges	35901-0011
89406GSK	n/a	Additional Volvo PDC Numbers - Additional OEM Interchanges	1091348
89407GSK	n/a	Additional Volvo PDC Numbers - Additional OEM Interchanges	1091350
89407GSK	n/a	Additional OEM Interchanges	5549899
89409GSK	n/a	Additional Volvo PDC Numbers - Additional OEM Interchanges	1091364
89410GSK	n/a	Additional Volvo PDC Numbers - Additional OEM Interchanges	3915947
89411GSK	n/a	Additional Volvo PDC Numbers - Additional OEM Interchanges	1091368
89412GSK	n/a	Additional Volvo PDC Numbers - Additional OEM Interchanges	3919055
89414GSK	n/a	Additional Volvo PDC Numbers - Additional OEM Interchanges	1091351
89414GSK	Rear	Additional Series - Models w/ OEM Number	35901-0001
89414GSK	n/a	Additional Series - Additional OEM Interchanges	37301-0001
89414GSK	n/a	Additional Volvo PDC Numbers - Additional OEM Interchanges	3916352
89414GSK	n/a	Additional Volvo PDC Numbers - Additional OEM Interchanges	3919585
89415GSK	Rear	FE Series - Models w/ Rear Air Suspension and OEM Number	8056892
89416GSK	n/a	Additional Volvo PDC Numbers - Additional OEM Interchanges	1093176
89416GSK	Rear	WG Series - Models w/ OEM Number	35901-3201
89416GSK	Rear	Pre - 1992 - WH Series - WHS, WHR, WHL or WHE - Models w/ OEM Number	35901-3201
89416GSK	Rear	Pre - 1992 - WCA & WIA Series - Models w/ OEM Number and up to VIN Number 657250	8071524

Part No.	Front/ Rear	Application & Model Information	OEM Part No.
89416GSK	Rear	Pre - 1992 - WG Series - Models w/ OEM Number	8071524
89416GSK	Rear	Pre - 1992 - WH Series - WHS, WHR, WHL or WHE - Models w/ OEM Number	8071524
89417GSK	n/a	Additional Volvo PDC Numbers - Additional OEM Interchanges	1093178
89417GSK	Front	WCA & WIA Series - Models w/ OEM Number	37301-0016
89417GSK	Front	WCA & WIA Series - Models w/ OEM Number	37301-0021
89417GSK	Front	WH Series - WHS, WHR, WHL or WHE Models w/ Front Single Shocks	37301-0021
89417GSK	Front	WCA & WIA Series - Models w/ OEM Number	37301-3202
89417GSK	Front	Additional Series - Models w/ OEM Number	665539
89417GSK	Front	WCA & WIA Series - Models w/ OEM Number	8065787
89417GSK	Front	Pre - 1992 - WG Series - Models w/ OEM Number	8065787
89418GSK	n/a	Additional Volvo PDC Numbers - Additional OEM Interchanges	1093100
89418GSK	Front	WCA & WIA Series - Models w/ OEM Number	37301-3201
89418GSK	Front	WG Series - Models w/ OEM Number	37301-3201
89418GSK	Front	Additional Series - Models w/ OEM Number	665410
89419GSK	n/a	Additional Volvo PDC Numbers - Additional OEM Interchanges	1091371
89420GSK	n/a	Additional Volvo PDC Numbers - Additional OEM Interchanges	1091373
89420GSK	Front	Additional Series - Models w/ OEM Number	70042
89422GSK	n/a	Additional Volvo PDC Numbers - Additional OEM Interchanges	1091374
89422GSK	n/a	Additional Volvo PDC Numbers - Additional OEM Interchanges	1091378
89422GSK	n/a	Additional Volvo PDC Numbers - Additional OEM Interchanges	3172948
89422GSK	n/a	Additional Series - Additional OEM Interchanges	35901-3420
89422GSK	Rear	Additional Series - 1500 Series - Models w/ Velvet Ride Suspension	530596
89422GSK	n/a	Additional Series - Additional OEM Interchanges	5534430
89422GSK	n/a	Additional Series - Additional OEM Interchanges	5534447
89423GSK	n/a	Additional Volvo PDC Numbers - Additional OEM Interchanges	1091379
89424GSK	n/a	Additional Volvo PDC Numbers - Additional OEM Interchanges	3915948
89425GSK	n/a	Additional Volvo PDC Numbers - Additional OEM Interchanges	3919561
89428GSK	n/a	Additional Volvo PDC Numbers - Additional OEM Interchanges	3915917
89430GSK	n/a	Additional Series - Additional OEM Interchanges	03-1106460
89430GSK	n/a	Additional Series - Additional OEM Interchanges	37301-0018
89434GSK	Rear	Additional Volvo PDC Numbers - Models w/ OEM Number	3919958
89434GSK	Rear	WG Series - Models w/ OEM Number	665623
89434GSK	Rear	1993 - 1995 - WCA & WIA Series - Models w/ OEM Number and after VIN Number 657841	8026658

Part No.	Front/ Rear	Application & Model Information	OEM Part No.
89434GSK	Rear	1993 - 1995 - WG Series - Models w/ OEM Number	8026658
89434GSK	Rear	1993 - 1995 - WH Series - WHS, WHR, WHL or WHE - Models w/ OEM Number	8026658
89435GSK	Rear	VN Series - 2200 - Models w/ OEM Number	665607
89435GSK	Rear	Additional Series - Models w/ OEM Number	665739
89435GSK	Rear	VN Series - 2200 - Models w/ OEM Number	8077874-P01
89435GSK	Rear	VN Series - 2200 - Models w/ OEM Number	8086053
89435GSK	Rear	Additional Series - Models w/ OEM Number	8169859
89435GSK	Rear	VN Series - 2200 - Models w/ OEM Number	8169859
89435GSK	Rear	1995 & Later - WCA & WIA Series - All w/ OEM Number and after VIN Number 723506 -	8169859
89435GSK	Rear	1995 & Later - WH Series - WHS, WHR, WHL or WHE Models w/ OEM Number	8169859
89436GSK	n/a	Additional Volvo PDC Numbers - Additional OEM Interchanges	1091367
89436GSK	n/a	Additional Volvo PDC Numbers - Additional OEM Interchanges	3919056
89440GSK	n/a	Additional Volvo PDC Numbers - Additional OEM Interchanges	1093180
89446GSK	n/a	Additional Volvo PDC Numbers - Additional OEM Interchanges	1091362
89447GSK	n/a	Additional Volvo PDC Numbers - Additional OEM Interchanges	1091358
89448GSK	Rear	May 1999 & Later - VN Series - 2200	20433425
89448GSK	Rear	May 1999 & Later - VNL Series - Models w/ 38,000 lb Rear Air Suspension built after May 1999	20433425
89448GSK	Rear	VN Series - 2200 - Models w/ OEM Number	20551628
89448GSK	Rear	2006 - 2011 - VNL Series - 64T-300, 64T-300U Models w/ 40,000 lb Rear Air Suspension	20551628
89448GSK	Rear	2006 - 2011 - VNL Series - 64T-630, 42T-630 Models w/ 40,000 lb Rear Air Suspension	20551628
89448GSK	Rear	2006 - 2011 - VNL Series - 64T-670 Models w/ 40,000 lb Rear Air Suspension	20551628
89448GSK	Rear	2006 - 2011 - VNL Series - 64T-730, 64T-730U Models w/ 40,000 lb Rear Air Suspension	20551628
89448GSK	Rear	2006 - 2011 - VNL Series - 64T-780 Models w/ 40,000 lb Rear Air Suspension	20551628
89448GSK	Rear	2006 - 2011 - VT Series - 64T-830 Models w/ 40,000 lb Rear Air Suspension	20551628
89448GSK	Rear	VN Series - 2200 - Models w/ OEM Number	471700000443
89448GSK	Rear	2006 - 2010 - VNL Series - 64T-300, 64T-300U Models w/ 40,000 lb Rear Air Suspension	471700000443

Part No.	Front/ Rear	Application & Model Information	OEM Part No.
89448GSK	Rear	2006 - 2010 - VNL Series - 64T-630, 42T-630 Models w/ 40,000 lb Rear Air Suspension	471700000443
89448GSK	Rear	2006 - 2010 - VNL Series - 64T-670 Models w/ 40,000 lb Rear Air Suspension	471700000443
89448GSK	Rear	2006 - 2010 - VNL Series - 64T-780 Models w/ 40,000 lb Rear Air Suspension	471700000443
89448GSK	Rear	2006 - 2010 - VT Series - 64T-830 Models w/ 40,000 lb Rear Air Suspension	471700000443
89448GSK	Rear	2008 - 2010 - VNL Series - 64T-730, 64T-730U Models w/ 40,000 lb Rear Air Suspension	471700000443
89448GSK	Rear	May 1999 & Later - VN Series - 2200	8086651
89450GSK	Front	Additional Volvo PDC Numbers - Models w/ OEM Number	141700000373
89450GSK	Front	VN Series - 2200 - Models w/ OEM Number	20433424
89450GSK	Front	2006 - 2010 - VNL Series - All Models w/ 12,000 - 13,200 lb Front Axles	20433424
89450GSK	Front	2006 - 2010 - VT Series - All Models w/ 12,000 - 13,200 lb Front Axles	20433424
89450GSK	Front	VN Series - 2200 - Models w/ OEM Number	20513881
89450GSK	Front	Additional Volvo PDC Numbers - Models w/ OEM Number	3092842
89450GSK	Front	Additional Volvo PDC Numbers - Models w/ OEM Number	3949241
89450GSK	Front	VN Series - 2200 - Models w/ OEM Number	8078195
89454GSK	Front	Models w/ Hendrickson Airtek	20485633
89454GSK	Front	2006 - 2011 - VNL Series - 64T-300, 64T-300U Models w/ Hendrickson Airtek	20485633
89454GSK	Front	2006 - 2011 - VNL Series - 64T-630, 42T-630 Models w/ Hendrickson Airtek	20485633
89454GSK	Front	2006 - 2011 - VNL Series - 64T-670 Models w/ Hendrickson Airtek	20485633
89454GSK	Front	2006 - 2011 - VNL Series - 64T-730, 64T-730U Models w/ Hendrickson Airtek	20485633
89454GSK	Front	2006 - 2011 - VNL Series - 64T-780 Models w/ Hendrickson Airtek	20485633
89454GSK	Front	Models w/ Hendrickson Airtek	64838-001
89454GSK	Front	Models w/ Hendrickson Airtek	64838-002

VOLVO-AUTOCAR

Table 7-144: Suspension & Ride Control - Shock Application: VOLVO-AUTOCAR

Part No.	Front/ Rear	Application & Model Information	OEM Part No.
89416GSK	Rear	ACM, ACL Models	35901-3201
89416GSK	Rear	Models w/ Air Suspension and OEM Number	8071524
89417GSK	Front	Models w/ OEM Number	37301-3202
89418GSK	Front	ACM, ACL Models	37301-3201
89430GSK	Front	A42B, A42F, A64B A64F - February 1971 & Later	03-1106460
89434GSK	Rear	Models w/ Air Suspension and OEM Number	8026658

WABASH NATIONAL

Table 7-145: Suspension & Ride Control - Shock Application: WABASH NATIONAL

Part No.	Front/ Rear	Application & Model Information	OEM Part No.
89407GSK	Rear	Trailers w/ Aurora part number	NEW900-44-089
89419GSK	Rear	Trailers w/ Aurora part number	FRUUCE1295-1
89419GSK	Rear	Trailers w/ Aurora part number	FRUUCE1295-901
89430GSK	Rear	Trailers w/ Aurora part number	NEW900-44-626
89436GSK	Rear	Trailers w/ Aurora part number	FLL83203-07I
89436GSK	Rear	Trailers w/ Aurora part number	FLL85000-07I
89436GSK	Rear	Trailers w/ Aurora part number	HENS-20001
89436GSK	Rear	Trailers w/ Aurora part number	HENS-20002
89436GSK	Rear	Trailers w/ Aurora part number	HENS-20126
89436GSK	Rear	Trailers w/ Aurora part number	HENS-23566
89436GSK	Rear	Trailers w/ Aurora part number	HENS-24088
89436GSK	Rear	Trailers w/ Aurora part number	NEW900-45-299

WATSON & CHALIN MFG. INC.

Table 7-146: Suspension & Ride Control - Shock Application: WATSON & CHALIN MFG. INC.

Part No.	Front/ Rear	Application & Model Information	OEM Part No.
89405GSK	Rear	WCTA Series Dump Trailer Air Suspension - TA-5000-DB-24, -DB-30, -F-24, -F-30	11724
89419GSK	Rear	Light Weight Trailer Air Suspension - TA-3175-9	17079
89430GSK	Rear	LWSL-1100-SR Self Steer Axle Suspension - SL-1100-LR	12128
89430GSK	Rear	Trailer Air Suspension - TA-2590-12, 14, 15 & 17	12128
89430GSK	Rear	WCTA Series Dump Trailer Air Suspension - TA-1900-18, -19	12128
89430GSK	Rear	WCTA Series Dump Trailer Air Suspension - TA-5000-DB-19, -F-19	12128
89430GSK	Rear	WCTA Series Trailer Air Suspension - TA-2075-9	12128
89430GSK	Rear	WCTA Series Trailer Air Suspension - TA-380-9	12128
89430GSK	Rear	WCWB Series Trailer Air Suspension - WB-2500-7.5, -9	12128
89430GSK	Rear	October 1989 & Later - WCTL-2200 Series Trailer Air Lift - TL-2590-12,14,15, & 17	12128
89430GSK	n/a	WCWB Series Trailer Air Suspension - Additional OEM Interchanges	665727
89436GSK	Rear	LWSL-1100-SR Self Steer Axle Suspension - HL-1100-20 FL	10147
89436GSK	Rear	Trailer Air Suspension - TA-2590-12-1	10147
89436GSK	Rear	WCTA Series Dump Trailer Air Suspension - TA-1900-15	10147
89436GSK	Rear	WCTA Series Dump Trailer Air Suspension - TA-525, -DB	10147
89436GSK	Rear	WCTA Series Trailer Air Suspension - TA-250-6, 7.5, 9	10147
89436GSK	Rear	WCTA Series Trailer Air Suspension - TA-251-6.5, -6.5FS	10147
89436GSK	Rear	WCTA Series Trailer Air Suspension - TA-251-7.5, -7.5FS	10147
89436GSK	Rear	WCTA Series Trailer Air Suspension - TA-251-8FS	10147
89436GSK	Rear	WCTA Series Trailer Air Suspension - TA-251-9.0, -9.0FS, -10	10147
89436GSK	Rear	WCTA Series Trailer Air Suspension - TA-255-9	10147
89436GSK	Rear	WCTA Series Trailer Air Suspension - TA-300-9	10147
89436GSK	Rear	WCTA-1200 Series Trailer Air Suspension - TA-1200-5	10147
89436GSK	Rear	WCWB Series Trailer Air Suspension - WB-251-6.5, 7.5, 9	10147
89436GSK	Rear	Models w/ OEM Number	10147HD
89436GSK	n/a	Additional OEM Interchanges	17186
89436GSK	n/a	Additional OEM Interchanges	17186-01
89436GSK	n/a	Additional OEM Interchanges	665724
89436GSK	Rear	Models w/ OEM Number	665862
89436GSK	n/a	Additional OEM Interchanges	680547
89436GSK	n/a	Additional OEM Interchanges	727603

WESTERN STAR

Table 7-147: Suspension & Ride Control - Shock Application: WESTERN STAR

Part No.	Front/ Rear	Application & Model Information	OEM Part No.
89406GSK	Rear	5900 & 6900 Series - Heritage Class - Models with OEM Number	35066-4413
89414GSK	Rear	5900 & 6900 Series - Heritage Class - Models with OEM Number	35901-0001
89406GSK	Rear	3800 Series - Heritage Class - With Hendrickson Rear Suspension	47902-13
89406GSK	Rear	4800 & 4900 Series - Constellation Class - With Hendrickson Rear Suspension	47902-13
89406GSK	Rear	4800 & 4900 Series - Heritage Class - With Hendrickson Rear Suspension	47902-13
89406GSK	Rear	5800 & 5900 Series - Constellation Class - 5842SS, 5864SS, 5942SS or 5964SS Constellation Class	47902-13
89406GSK	Rear	5900 & 6900 Series - Heritage Class - With Hendrickson Rear Suspension	47902-13
89406GSK	Rear	3800 Series - Heritage Class - With Hendrickson Rear Suspension	47902-8
89406GSK	Rear	4800 & 4900 Series - Constellation Class - With Hendrickson Rear Suspension	47902-8
89406GSK	Rear	4800 & 4900 Series - Heritage Class - With Hendrickson Rear Suspension	47902-8
89406GSK	Rear	5800 & 5900 Series - Constellation Class - 5842SS, 5864SS, 5942SS or 5964SS Constellation Class	47902-8
89406GSK	Rear	5900 & 6900 Series - Heritage Class - With Hendrickson Rear Suspension	47902-8
89414GSK	Rear	3800 Series - Heritage Class - With Neway Rear Suspension	90044025
89414GSK	Rear	4800 & 4900 Series - Constellation Class - With Neway Rear Suspension	90044025
89414GSK	Rear	4800 & 4900 Series - Heritage Class - With Neway Rear Suspension	90044025
89414GSK	Rear	5800 & 5900 Series - Constellation Class - With Neway Rear Suspension	90044025
89414GSK	Rear	5900 & 6900 Series - Heritage Class - With Neway Rear Suspension	90044025
89422GSK	n/a	5900 & 6900 Series - Heritage Class - Additional OEM Interchanges	35901-3420
89442GSK	Front	4800 & 4900 Series - Constellation Class - 4842FX, 4864FX, 4964EX, 4964EX, 4942SX or 4964SX Constellation Class	37301-3401
89442GSK	Front	4800 & 4900 Series - Heritage Class - 4842F, 4864F, 4843S, 4864S, 4942F, 4964F, 4942S or 4964S Heritage Class	37301-3401
89442GSK	Front	5800 & 5900 Series - Constellation Class - 5842SS, 5864SS, 5942SS or 5964SS Constellation Class	37301-3401
89442GSK	Front	5900 & 6900 Series - Heritage Class - 5942S, 5964S, 6964F or 6964S Heritage Class	37301-3401

Part No.	Front/ Rear	Application & Model Information	OEM Part No.
89442GSK	Front	4800 & 4900 Series - Constellation Class - 4842FX, 4864FX, 4964EX, 4964EX, 4942SX or 4964SX Constellation Class	37301-3404
89442GSK	Front	4800 & 4900 Series - Heritage Class - 4842F, 4864F, 4843S, 4864S, 4942F, 4964F, 4942S or 4964S Heritage Class	37301-3404
89442GSK	Front	5800 & 5900 Series - Constellation Class - 5842SS, 5864SS, 5942SS or 5964SS Constellation Class	37301-3404
89442GSK	Front	5900 & 6900 Series - Heritage Class - 5942S, 5964S, 6964F or 6964S Heritage Class	37301-3404
89442GSK	Front	5900 & 6900 Series - Heritage Class - Models with OEM Number	37301-3405
89442GSK	Front	4800 & 4900 Series - Constellation Class - 4842FX, 4864FX, 4964EX, 4964EX, 4942SX or 4964SX Constellation Class	37301-3409
89442GSK	Front	4800 & 4900 Series - Heritage Class - 4842F, 4864F, 4843S, 4864S, 4942F, 4964F, 4942S or 4964S Heritage Class	37301-3409
89442GSK	Front	5800 & 5900 Series - Constellation Class - 5842SS, 5864SS, 5942SS or 5964SS Constellation Class	37301-3409
89442GSK	Front	5900 & 6900 Series - Heritage Class - 5942S, 5964S, 6964F or 6964S Heritage Class	37301-3409
89442GSK	Front	4800 & 4900 Series - Constellation Class - 4842FX, 4864FX, 4964EX, 4964EX, 4942SX or 4964SX Constellation Class	37301-3412
89442GSK	Front	4800 & 4900 Series - Heritage Class - 4842F, 4864F, 4843S, 4864S, 4942F, 4964F, 4942S or 4964S Heritage Class	37301-3412
89442GSK	Front	5800 & 5900 Series - Constellation Class - 5842SS, 5864SS, 5942SS or 5964SS Constellation Class	37301-3412
89442GSK	Front	5900 & 6900 Series - Heritage Class - 5942S, 5964S, 6964F or 6964S Heritage Class	37301-3412
89442GSK	Front	3800 Series - Heritage Class - 3842S, 3864S	37390-4401
89442GSK	Front	4800 & 4900 Series - Constellation Class - 4842FX, 4864FX, 4964EX, 4964EX, 4942SX or 4964SX Constellation Class	37390-4401
89442GSK	Front	4800 & 4900 Series - Heritage Class - 4842F, 4864F, 4843S, 4864S, 4942F, 4964F, 4942S or 4964S Heritage Class	37390-4401
89442GSK	Front	5800 & 5900 Series - Constellation Class - 5842SS, 5864SS, 5942SS or 5964SS Constellation Class	37390-4401
89442GSK	Front	5900 & 6900 Series - Heritage Class - 5942S, 5964S, 6964F or 6964S Heritage Class	37390-4401
89442GSK	Front	3800 Series - Heritage Class - 3842S, 3864S	37390-4402
89442GSK	Front	4800 & 4900 Series - Constellation Class - 4842FX, 4864FX, 4964EX, 4964EX, 4942SX or 4964SX Constellation Class	37390-4402
89442GSK	Front	4800 & 4900 Series - Heritage Class - 4842F, 4864F, 4843S, 4864S, 4942F, 4964F, 4942S or 4964S Heritage Class	37390-4402

Part No.	Front/ Rear	Application & Model Information	OEM Part No.
89442GSK	Front	5800 & 5900 Series - Constellation Class - 5842SS, 5864SS, 5942SS or 5964SS Constellation Class	37390-4402
89442GSK	Front	5900 & 6900 Series - Heritage Class - 5942S, 5964S, 6964F or 6964S Heritage Class	37390-4402
89442GSK	Front	3800 Series - Heritage Class - 3842S, 3864S	37390-4403
89442GSK	Front	4800 & 4900 Series - Constellation Class - 4842FX, 4864FX, 4964EX, 4964EX, 4942SX or 4964SX Constellation Class	37390-4403
89442GSK	Front	4800 & 4900 Series - Heritage Class - 4842F, 4864F, 4843S, 4864S, 4942F, 4964F, 4942S or 4964S Heritage Class	37390-4403
89442GSK	Front	5800 & 5900 Series - Constellation Class - 5842SS, 5864SS, 5942SS or 5964SS Constellation Class	37390-4403
89442GSK	Front	5900 & 6900 Series - Heritage Class - 5942S, 5964S, 6964F or 6964S Heritage Class	37390-4403
89442GSK	Front	5900 & 6900 Series - Heritage Class - Models with OEM Number	665682
89453GSK	Front	Pre - June 2010 - 5900 & 6900 Series - Heritage Class - Models with Hendrickson Airtek Suspension	58913-003
89453GSK	Front	July 2010 & Later - 5900 & 6900 Series - Heritage Class - Models with Hendrickson Airtek Suspension	58913-012

WESTERN UNIT "STABILAIRE" SUSPENSION

Table 7-148: Suspension & Ride Control - Shock Application: WESTERN UNIT "STABILAIRE" SUSPENSION

Part No.	Front/ Rear	Application & Model Information	OEM Part No.
89419GSK	Rear	Models w/ OEM Number	80600
89422GSK	Rear	Models w/ OEM Number	4939967

SHOCK DIMENSIONAL INFORMATION

Cab, Sleeper Springs

See Page 7-120



Table 7-149: Suspension & Ride Control - Shocks (Front)

Part No.	Mounting Style	Bore (U.S.)	Extended Length	Collapsed Length	Stroke Length	Recoil Cutoff
89456GSK	Bushing and Threaded	1-5/8" (4.1cm)	17-1/32" (43.23cm)	11-9/32" (28.68cm)	5-47/64" (14.55cm)	Yes
89436GSK	Bushings Both Ends	1-5/8" (4.1cm)	17-1/4" (43.8cm)	11-15/16" (30.3cm)	5-5/16" (13.5cm)	Yes
89415GSK	Bushing Both Ends	1-5/8" (4.1cm)	20-1/8" (51.1cm)	13-5/16" (33.8cm)	6-13/16" (17.3cm)	Yes
89437GSK	Bushings Both Ends	1-5/8" (4.1cm)	20-1/8" (51.1cm)	13-5/16" (33.8cm)	6-13/16" (17.3cm)	Yes
89428GSK	Bushing and Threaded	1-5/8" (4.1cm)	21-15/16" (55.7cm)	14-1/8" (35.9cm)	7-13/16" (19.8cm)	Yes
89443GSK	Straddle Mount Both Ends	1-5/8" (4.1cm)	22-11/64" (56.31cm)	14-5/16" (36.35cm)	7-7/8" (19.96cm)	Yes
89420GSK	Bushings Both Ends	1-5/8" (4.1cm)	22-13/16" (57.9cm)	14-11/16" (37.3cm)	8-1/8" (20.6cm)	No
89458GSK	Straddle Mount Both Ends	1-5/8" (4.1cm)	22-31/64" (57.1cm)	14-1/2" (36.83cm)	7-63/64" (20.27cm)	Yes
89440GSK	Bushings Both Ends	1-5/8" (4.1cm)	23-7/8" (60.6cm)	15-3/16" (38.6cm)	8-11/16" (22.1cm)	Yes
89447GSK	Threaded Both Ends	1-5/8" (4.1cm)	24-1/32" (61.04cm)	14-1/4" (36.2cm)	9-25/32" (24.84cm)	No
89406GSK	Bushings Both Ends	1-5/8" (4.1cm)	24-3/4" (62.9cm)	15-11/16" (39.8cm)	9-1/16" (23.0cm)	Yes
89448GSK	Bushings Both Ends	1-5/8" (4.1cm)	24-5/8" (62.5cm)	15-9/16" (39.5cm)	9-1/16" (23.0cm)	Yes
89422GSK	Bushings Both Ends	1-5/8" (4.1cm)	25-1/8" (63.8cm)	16-3/16" (41.1cm)	8-13/16" (22.4cm)	Yes

Part No.	Mounting Style	Bore (U.S.)	Extended Length	Collapsed Length	Stroke Length	Recoil Cutoff
89411GSK	Bushings Both Ends	1-5/8" (4.1cm)	25-3/8" (64.5cm)	15-9/16" (39.5cm)	9-3/4" (24.8cm)	Yes
89425GSK	Bushings Both Ends	1-5/8" (4.1cm)	26-1/2" (67.3cm)	16-13/16" (42.7cm)	9-11/16" (24.6cm)	Yes
89405GSK	Bushings Both Ends	1-5/8" (4.1cm)	26-1/4" (66.7cm)	16-7/16" (41.8cm)	9-13/16" (24.9cm)	Yes
89410GSK	Bushings Both Ends	1-5/8" (4.1cm)	26-5/16" (66.8cm)	16-7/16" (41.8cm)	9-15/16" (25.2cm)	No
89455GSK	Threaded Both Ends	1-5/8" (4.1cm)	26-9/32" (66.75cm)	15-15/16" (40.49cm)	10-11/32" (26.26cm)	Yes
89434GSK	Bushings Both Ends	1-5/8" (4.1cm)	27-1/8" (68.9cm)	16-13/16" (42.7cm)	10-5/16" (26.2cm)	Yes
89427GSK	Bushing and Threaded	1-5/8" (4.1cm)	27-3/16" (69.1cm)	17-1/2" (44.5cm)	9-11/16" (24.6cm)	Yes
89416GSK	Bushings Both Ends	1-5/8" (4.1cm)	28-5/8" (72.7cm)	17-9/16" (44.6cm)	11-1/16" (28.1cm)	Yes
89419GSK	Bushings Both Ends	1-5/8" (4.1cm)	18" (45.7cm)	12-9/16" (31.9cm)	5-7/16" (13.8cm)	Yes
89454GSK	Straddle Mount Both Ends	1-5/8" (4.1cm)	18-15/64" (46.30cm)	12-45/64" (32.28cm)	5-1/2" (14.02cm)	Yes
89423GSK	Bushings Both Ends	1-5/8" (4.1cm)	18-5/8" (47.3cm)	12-1/16" (30.6cm)	6-9/16" (16.7cm)	Yes
89408GSK	Bushings Both Ends	1-5/8" (4.1cm)	19-11/16" (50.0cm)	12-13/16" (32.5cm)	6-7/8" (17.5cm)	No
89457GSK	Bushings Both Ends	1-5/8" (4.1cm)	20-13/32" (51.84cm)	12-31/32" (32.92cm)	7-15/32" (18.95cm)	No
89413GSK	Bushings Both Ends	1-5/8" (4.1cm)	20-15/16" (53.2cm)	13-7/16" (34.1cm)	7-1/2" (19.1cm)	No
89460GSK	Straddle Mount Both Ends	1-5/8" (4.1cm)	20-19/32" (52.3cm)	13-1/32" (33.1cm)	7-9/16" (19.23cm)	No
89426GSK	Bushing and Threaded	1-5/8" (4.1cm)	20-7/16" (51.9cm)	12-15/16" (32.9cm)	7-1/2" (19.1cm)	No
89453GSK	Straddle Mount and Bushing	1-5/8" (4.1cm)	21-15/64" (53.92cm)	13-5/8" (34.6cm)	7-39/64" (19.33cm)	Yes
89407GSK	Bushings Both Ends	1-5/8" (4.1cm)	21-5/8" (54.9cm)	14-1/16" (35.7cm)	7-9/16" (19.2cm)	Yes
89418GSK	Threaded Both Ends	1-5/8" (4.1cm)	21-7/16" (54.5cm)	13-3/16" (33.5cm)	8-1/4" (21.0cm)	No
89417GSK	Bushing and Threaded	1-5/8" (4.1cm)	22-15/16" (58.3cm)	14-3/16" (36.0cm)	8-3/4" (22.2cm)	No

Part No.	Mounting Style	Bore (U.S.)	Extended Length	Collapsed Length	Stroke Length	Recoil Cutoff
89431GSK	Bushings Both Ends	1-5/8" (4.1cm)	22-7/16" (57.0cm)	14-3/16" (36.0cm)	8-1/4" (21.0cm)	No
89449GSK	Bushings Both Ends	1-5/8" (4.1cm)	23-1/16" (58.6cm)	14-11/16" (37.3cm)	8-3/8" (21.3cm)	No
89424GSK	Bushing and Threaded	1-5/8" (4.1cm)	23-11/16" (60.2cm)	15" (38.1cm)	8-11/16" (22.1cm)	Yes
89438GSK	Bushings Both Ends	1-5/8" (4.1cm)	23-3/16" (58.9cm)	14-9/16" (37.0cm)	8-5/8" (21.9cm)	No
89432GSK	Bushings Both Ends	1-5/8" (4.1cm)	23-7/16" (59.5cm)	14-11/16" (37.3cm)	8-3/4" (22.2cm)	No
89412GSK	Bushings Both Ends	1-5/8" (4.1cm)	24-1/4" (61.6cm)	15-11/16" (39.8cm)	8-9/16" (21.7cm)	Yes
89430GSK	Bushings Both Ends	1-5/8" (4.1cm)	24-3/4" (62.9cm)	15-9/16" (39.5cm)	9-1/2" (24.1cm)	Yes
89450GSK	Bushings Both Ends	1-5/8" (4.1cm)	24-5/8" (62.5cm)	15-9/16" (39.5cm)	9-1/16" (23.0cm)	Yes
89402GSK	Bushings Both Ends	1-5/8" (4.1cm)	24-7/16" (62.1cm)	15-3/16" (38.6cm)	9-1/4" (23.5cm)	No
89435GSK	Bushings Both Ends	1-5/8" (4.1cm)	24-7/8" (63.2cm)	15-11/16" (39.8cm)	9-3/16" (23.3cm)	Yes
89442GSK	Bushings Both Ends	1-5/8" (4.1cm)	24-9/16" (62.4cm)	15-9/16" (39.5cm)	9" (22.9cm)	No
89439GSK	Bushings Both Ends	1-5/8" (4.1cm)	25-11/16" (65.2cm)	15-13/16" (40.2cm)	9-7/8" (25.1cm)	No
89459GSK	Straddle Mount and Bushing	1-5/8" (4.1cm)	25-29/64" (65.02cm)	15-53/64" (40.18cm)	9-25/32" (24.84cm)	No
89429GSK	Bushings Both Ends	1-5/8" (4.1cm)	26-3/16" (66.5cm)	16-7/16" (41.8cm)	9-3/4" (24.8cm)	No
89409GSK	Bushings Both Ends	1-5/8" (4.1cm)	26-3/8" (67.0cm)	16-7/16" (41.8cm)	9-13/16" (24.9cm)	Yes
89446GSK	Bushings Both Ends	1-5/8" (4.1cm)	28-3/8" (72.1cm)	17-7/16" (44.3cm)	10-13/16" (27.5cm)	Yes
89401GSK	Bushings Both Ends	1-5/8" (4.1cm)	28-7/16" (72.2cm)	17-3/16" (43.7cm)	11-1/4" (28.6cm)	No
89414GSK	Bushings Both Ends	1-5/8" (4.1cm)	29-5/8" (75.2cm)	18-1/16" (45.9cm)	11-9/16" (29.4cm)	Yes
89451GSK	Straddle Mount Both Ends	1-5/8" (4.1cm)	30-23/64" (77.11cm)	18-13/32" (46.76cm)	11-61/64" (30.35cm)	Yes

CROSS REFERENCE FOR SHOCKS

CROSS REFERENCE FOR SHOCKS

Table 7-150: Cross Reference for Shocks

OEM Part No.	Part No.	Page No.
ACF BRILL BUS		
631237	89422GSK	7-136
641521	89422GSK	7-136
649648	89422GSK	7-136
659129	89422GSK	7-136
ALLCO TRAILER		
727602	89406GSK	7-136
AM GENERAL		
5979484	89420GSK	7-136
ARVIN MERITOR		
654907	89436GSK	7-136
BENSON TRUCK BODIES INC.		
90044089	89407GSK	7-136
A-20002	89436GSK	7-136
BLUE BIRD		
70317	89402GSK	7-137
1668722	89440GSK	7-137
1668730	89414GSK	7-137
1722214	89440GSK	7-137
1722222	89414GSK	7-137
1962430	89407GSK	7-137
2021459	89413GSK	7-137
AMS65109	89432GSK	7-137
AMS65110	89430GSK	7-137
BROCKWAY SCHOOL BUS		
515231	89422GSK	7-137
530873	89407GSK	7-137

OEM Part No.	Part No.	Page No.
BUS & TRUCK CO.		
70039	89422GSK	7-138
680091	89422GSK	7-138
CHALMERS SUSPENSION		
800781	89425GSK	7-138
CHANCE BUS		
6892	89407GSK	7-138
6893	89436GSK	7-138
59039	89407GSK	7-138
728600	89436GSK	7-138
CHEVROLET TRUCK		
684280	89414GSK	7-140
3171462	89430GSK	7-142
3172948	89422GSK	7-141
3188626	89419GSK	7-141
3188729	89422GSK	7-141
3192890	89430GSK	7-142
4939852	89422GSK	7-141
4939967	89422GSK	7-141
4940600	89414GSK	7-141
4940606	89430GSK	7-142
4940627	89436GSK	7-145
4940650	89407GSK	7-140
4940660	89407GSK	7-140
4940662	89430GSK	7-146
4975429	89419GSK	7-141
4975467	89407GSK	7-140
4975494	89407GSK	7-143
4975497	89430GSK	7-147
5348631	89436GSK	7-147
5353054	89422GSK	7-141
5357955	89419GSK	7-141
5357959	89419GSK	7-141
5374779	89422GSK	7-141
5392387	89422GSK	7-141
5522794	89422GSK	7-141

OEM Part No.	Part No.	Page No.
5527001	89419GSK	7-141
5532425	89407GSK	7-143
5532433	89407GSK	7-143
5534430	89422GSK	7-141
5534447	89422GSK	7-141
5544060	89420GSK	7-141
5544581	89420GSK	7-141
5549899	89407GSK	7-143
5552210	89422GSK	7-141
5552244	89422GSK	7-141
5552451	89422GSK	7-142
5552452	89422GSK	7-144, 7-145
5552552	89422GSK	7-142
5554184	89420GSK	7-141
5554596	89422GSK	7-141
5554814	89420GSK	7-141
5559363	89436GSK	7-145
12474915	89406GSK	7-140
15963161	89406GSK	7-143
22002293	89430GSK	7-143
22007700	89407GSK	7-140
22007701	89430GSK	7-143
22007750	89407GSK	7-140
22012090	89422GSK	7-142
22012091	89422GSK	7-141, 7-142
22012095	89430GSK	7-142, 7-143, 7-144
22012166	89430GSK	7-143, 7-144
22046489	89422GSK	7-141
22065251	89440GSK	7-145
9-51630-666-0	89413GSK	7-141
9-51630-666-2	89413GSK	7-141
CONTINENTAL TRAILWAYS-EAGLE INTERNATIONAL		
70039	89422GSK	7-145
680091	89422GSK	7-145
01-0100-905	89422GSK	7-145

OEM Part No.	Part No.	Page No.
CROWN CARRIER		
680091	89422GSK	7-144
277A-13	89420GSK	7-144
277A-8	89422GSK	7-144
CROWN COACH		
3188729	89422GSK	7-144
DURA SUSPENSION		
12866	89407GSK	7-145
59030	89436GSK	7-145
665133	89436GSK	7-145
1080099	89436GSK	7-145
EAGLE MOTOR COACH		
70039	89422GSK	7-145
680091	89422GSK	7-145
01-0100-905	89422GSK	7-145
014-0100-905	89422GSK	7-145
154-0100-514	89425GSK	7-145
EAST MANUFACTURING CORP.		
517-05001-23	89430GSK	7-145
517-05006-20	89440GSK	7-145
517-05110-20	89436GSK	7-145
517-05805-20	89436GSK	7-145
517-05809-20	89437GSK	7-145
517-05916-14	89407GSK	7-145
FLXIBLE BUS		
97-2210-00160	89447GSK	7-146
97-9999-02633	89424GSK	7-146
FORD		
70127	89401GSK	7-146
70128	89401GSK	7-146
90044769	89407GSK	7-147
90044770	89407GSK	7-147
90045068	89402GSK	7-146

OEM Part No.	Part No.	Page No.
47902-13	89406GSK	7-147
47902-28	89414GSK	7-150
47902-8	89406GSK	7-147
57365-111	89401GSK	7-146
AX267A	89446GSK	7-153
B8QZ-18124-A	89409GSK	7-147
C1TT-18045-C	89409GSK	7-147
C1TZ-18045-C	89409GSK	7-147
C1TZ-18124-C	89409GSK	7-147
C1TZ-18124-D	89446GSK	7-153
C4HZ-18124-A	89409GSK	7-147
C4HZ-18124-B	89446GSK	7-153
C4HZ-18124-D	89409GSK	7-147
C4HZ-18124-E	89446GSK	7-153
C6PF-18077-DL	89409GSK	7-148
C7HZ-18124-A	89409GSK	7-148
C8HA-18045-A	89409GSK	7-148
D0HA-18045-D	89446GSK	7-153
D0HA-18045-E	89409GSK	7-148
D0HZ-18124-A	89446GSK	7-153
D0HZ-18124-B	89409GSK	7-148
D1TF-18045-LA	89409GSK	7-148
D2EF-18045-AA	89409GSK	7-148
D2EF-18124-AA	89409GSK	7-149
D2HF-18045-BA	89446GSK	7-153
D2HF-18045-DA	89409GSK	7-149
D2HT-18045-EA	89409GSK	7-149
D2HZ-18080-A	89414GSK	7-154
D2HZ-18125-A	89414GSK	7-154
D2HZ-18125-B	89414GSK	7-154
D2KF-18045-AA	89409GSK	7-149
D2KF-18124-AA	89409GSK	7-153
D2TF-18045-AA	89409GSK	7-153
D2TF-18124-F	89446GSK	7-157
D2TZ-18124-E	89409GSK	7-153
D2TZ-18124-F	89446GSK	7-153
D2TZ-18124-J	89409GSK	7-153
D4HA-18080-A	89414GSK	7-154
D4HA-18080-AA	89414GSK	7-154

OEM Part No.	Part No.	Page No.
D5TZ-18124-C	89409GSK	7-149
D7HA-18080-AA	89405GSK	7-147
D7HF-18045-FA	89409GSK	7-149
D7HT-18045-BA	89409GSK	7-149
D7HT-18045-DA	89446GSK	7-153
D7HT-18045-EA	89409GSK	7-149
D7HT-18045-HA	89413GSK	7-150
D7HT-18124-BA	89409GSK	7-149
D7HT-18124-DA	89446GSK	7-153
D7HT-18124-EA	89409GSK	7-149
D7HT-18124-FA	89409GSK	7-149
D7HT-18125-FA	89405GSK	7-151
D7KF-18045-EA	89409GSK	7-149
D8HZ-18125-A	89414GSK	7-151
D8HZ-18125-B	89405GSK	7-147
E0HT-18045-AA	89446GSK	7-153
E0HT-18045-AB	89446GSK	7-153
E0HZ-18124-A	89446GSK	7-153
E1TA-18045-AA	89446GSK	7-153
E1TD-18045-AA	89446GSK	7-154
E9HS-18045-AA	89446GSK	7-154
E9HZ-18124-A	89446GSK	7-154
F0HS-18045-AA	89401GSK	7-146
F0HT-18045-CA	89401GSK	7-146
F0HT-18080-AA	89430GSK	7-155
F0HZ-18125-A	89430GSK	7-155
F1HT-18045-AA	89446GSK	7-154
F1HT-18045-DA	89409GSK	7-149
F1HT-18045-EA	89402GSK	7-146
F1HT-18045-EB	89402GSK	7-146
F1HT-18045-GA	89401GSK	7-146
F1HT-18045-HB	89401GSK	7-146
F1HT-18045-LB	89401GSK	7-146
F1HT-18045-RA	89402GSK	7-147
F1HT-18045-RB	89402GSK	7-147
F1HZ-18124-A	89446GSK	7-154
F1HZ-18124-AA	89446GSK	7-154

OEM Part No.	Part No.	Page No.
F1HZ-18124-C	89402GSK	7-147
F1HZ-18124-D	89401GSK	7-146
F1HZ-18124-E	89401GSK	7-146
F1HZ-18124-F	89401GSK	7-146
F1HZ-18124-G	89401GSK	7-146
F1HZ-18124-K	89402GSK	7-147
F4HT-18080-AA	89425GSK	7-151
F4HT-18080-AB	89425GSK	7-151
F4HT-18080-BA	89410GSK	7-150
F5HZ-18125-A	89425GSK	7-151
F5HZ-18125-AA	89425GSK	7-151
F5HZ-18125-B	89410GSK	7-150
F5HZ-18125-BA	89410GSK	7-150
F5HZ-18125-DA	89425GSK	7-151
F6HT-18045-AA	89438GSK	7-151
F6HT-18045-AC	89438GSK	7-151
F6HT-18045-BC	89435GSK	7-151
F6HT-18045-CC	89439GSK	7-152
F6HT-18045-EB	89439GSK	7-152
F6HT-18045-EC	89439GSK	7-152
F6HT-18045-GB	89440GSK	7-153
F6HT-18045-GC	89440GSK	7-153
F6HT-18045-HB	89438GSK	7-152
F6HT-18045-HC	89438GSK	7-152
F6HT-18045-MA	89401GSK	7-150
F6HT-18080-CA	89425GSK	7-155
F6HT-18080-FC	89414GSK	7-150
F6HZ-18080-FC	89414GSK	7-150
F6HZ-18124-A	89438GSK	7-152
F6HZ-18124-C	89439GSK	7-152
F6HZ-18124-D	89439GSK	7-153
F6HZ-18124-E	89439GSK	7-152
F6HZ-18124-F	89439GSK	7-152
F6HZ-18124-G	89438GSK	7-152
F6HZ-18124-H	89438GSK	7-152
F6HZ-18124-MA	89401GSK	7-146

OEM Part No.	Part No.	Page No.
F6HZ-18125-A	89425GSK	7-151
F6HZ-18125-C	89402GSK	7-147
F6HZ-18125-D	89414GSK	7-151
TANNA-18045-A	89409GSK	7-150
TQSH-18045-A	89446GSK	7-154

FREIGHTLINER

70029	89422GSK	7-155
70042	89420GSK	7-155
535228	89420GSK	7-155
659300	89430GSK	7-156
665236	89412GSK	7-155
671908	89449GSK	7-160
680008	89419GSK	7-155
680009	89420GSK	7-155
680017	89420GSK	7-155
680339	89443GSK	7-157
680442	89428GSK	7-155
680611	89443GSK	7-158
61300224	89449GSK	7-160
10-12030-002	89429GSK	7-156
10-12032-000	89429GSK	7-156
10-12032-001	89429GSK	7-156
10-12032-002	89429GSK	7-156
10-12032-003	89429GSK	7-156
10-12032-004	89429GSK	7-156
10-12046-000	89429GSK	7-156
10-12703-000	89449GSK	7-159
10-13021-000	89449GSK	7-159
10-13063-000	89449GSK	7-159
10-13211-000	89449GSK	7-159
10-13634-000	89449GSK	7-159
10-13776-000	89430GSK	7-156
10-13859-000	89430GSK	7-156
16-11133-000	89412GSK	7-155
16-12117-000	89412GSK	7-155
16-13947-000	89428GSK	7-159

OEM Part No.	Part No.	Page No.
16-13957-000	89443GSK	7-156
16-14759-000	89436GSK	7-156
16-15817-000	89443GSK	7-157
16-18705-000	89412GSK	7-155
16-19138-000	89431GSK	7-156
47902-13	89406GSK	7-155
58913-003	89453GSK	7-160
58913-012	89453GSK	7-161
681-326-0400	89428GSK	7-155
SDA471700002809	89443GSK	7-158

FREIGHTLINER CUSTOM CHASSIS

654953	89431GSK	7-161
659227	89431GSK	7-161
10-13859-000	89430GSK	7-161
16-15676-000	89431GSK	7-161
16-17684-000	89431GSK	7-161
16-19138-000	89431GSK	7-161

FRUEHAUF

680117	89419GSK	7-161
144-5910	89419GSK	7-161
5116-117	89406GSK	7-161
UCD-006216-001	89436GSK	7-161
UCD-6216-1	89436GSK	7-162
UCE-1295-1	89419GSK	7-161
UCE-1295-901	89419GSK	7-161
UCE-9399-1	89406GSK	7-161
UEY 1124-001	89440GSK	7-162

FWD TRUCK

450739	89420GSK	7-162
--------	----------	-------

GILLIG BROS.

70034	89420GSK	7-162
680009	89420GSK	7-162
90044046	89405GSK	7-162
90044683	89406GSK	7-162
90044769	89407GSK	7-162

OEM Part No.	Part No.	Page No.
90044770	89407GSK	7-162
82-01878	89406GSK	7-162
GMC TRUCK		
684280	89414GSK	7-164
3171462	89430GSK	7-166
3172948	89422GSK	7-164
3188626	89419GSK	7-164
3188729	89422GSK	7-164
3192890	89430GSK	7-167
4939852	89422GSK	7-164
4939967	89422GSK	7-164
4940600	89414GSK	7-164
4940606	89430GSK	7-167
4940627	89436GSK	7-168
4940650	89407GSK	7-167
4940660	89407GSK	7-167
4940662	89430GSK	7-168
4975429	89419GSK	7-164
4975467	89407GSK	7-163
4975494	89407GSK	7-163
4975497	89430GSK	7-168
5348631	89436GSK	7-168
5353054	89422GSK	7-164
5357955	89419GSK	7-164
5357959	89419GSK	7-164
5374779	89422GSK	7-164
5392387	89422GSK	7-165
5522794	89422GSK	7-165
5527001	89419GSK	7-164
5532425	89407GSK	7-163
5532433	89407GSK	7-163
5533699	89420GSK	7-164
5534430	89422GSK	7-165
5534447	89422GSK	7-165
5544060	89420GSK	7-164
5544581	89420GSK	7-164

OEM Part No.	Part No.	Page No.
5549899	89407GSK	7-163
5552210	89422GSK	7-165
5552244	89422GSK	7-165
5552451	89422GSK	7-165
5552452	89422GSK	7-165
5552454	89420GSK	7-164
5554184	89420GSK	7-164
5554596	89422GSK	7-165
5554814	89420GSK	7-164
5559363	89436GSK	7-168
12474915	89406GSK	7-163
15963161	89406GSK	7-163
22002293	89430GSK	7-165
22007701	89430GSK	7-165
22007750	89407GSK	7-163
22012090	89422GSK	7-164
22012091	89422GSK	7-164
22012095	89430GSK	7-165
22012166	89430GSK	7-166
22046489	89422GSK	7-164
22065251	89440GSK	7-168
90044769	89407GSK	7-163
90044770	89407GSK	7-163
8-51630-666-0	89413GSK	7-163
9-51630-666-0	89413GSK	7-163
9-51630-666-2	89413GSK	7-164
GRANNING SUSPENSION		
680162	89419GSK	7-168
GREAT DANE TRAILER		
18163-01	89407GSK	7-169
18164-01	89406GSK	7-169
HENS-20001	89436GSK	7-169
HENS-20002	89436GSK	7-169
HENS-20126	89436GSK	7-169
HENS-23566	89436GSK	7-169
HENS-24088	89436GSK	7-169

OEM Part No.	Part No.	Page No.
GREYHOUND BUS		
12 TA-01-013	89422GSK	7-169
HARDEE MFG		
8030223	89407GSK	7-169
HENDRICKSON TRAILER SUSPENSION SYSTEMS		
654951	89436GSK	7-170
665405	89440GSK	7-172
665531	89436GSK	7-170
665532	89414GSK	7-170
665533	89430GSK	7-170
665536	89436GSK	7-170
665756	89436GSK	7-170
665766	89436GSK	7-170
671948	89436GSK	7-170
680341	89436GSK	7-170
680467	89436GSK	7-170
680568	89436GSK	7-170
680570	89437GSK	7-170
680702	89436GSK	7-170
680756	89436GSK	7-170
98583-019	89436GSK	7-170
A-14583	89436GSK	7-170
A-1667	89436GSK	7-170
A-1668	89436GSK	7-170
A-20001	89436GSK	7-171
A-20002	89436GSK	7-171
A-20126	89436GSK	7-171
A-20886	89440GSK	7-172
A-20887	89430GSK	7-170
A-20889	89436GSK	7-171
A-2218	89440GSK	7-172
A-2230	89430GSK	7-170
A-2232	89430GSK	7-170
A-2240	89414GSK	7-170
A-4084	89430GSK	7-170
A-4089	89414GSK	7-170
B-21832	89436GSK	7-171

OEM Part No.	Part No.	Page No.
B-22715	89436GSK	7-171
B-23013	89436GSK	7-171
B-23316	89437GSK	7-172
B-23362	89437GSK	7-172
B-23566	89436GSK	7-171
B-24088	89436GSK	7-171
B-24125	89436GSK	7-171
B-26652	89436GSK	7-172
B-29432	89436GSK	7-172
S-14583	89436GSK	7-172
S-1667	89436GSK	7-172
S-1668	89436GSK	7-172
S-20001	89436GSK	7-172
S-20002	89436GSK	7-172
S-20126	89436GSK	7-172
S-20886	89440GSK	7-172
S-20887	89430GSK	7-170
S-20889	89436GSK	7-172
S-21832	89436GSK	7-172
S-2218	89440GSK	7-172
S-2230	89430GSK	7-170
S-2232	89430GSK	7-170
S-2240	89414GSK	7-170
S-23013	89436GSK	7-172
S-23316	89437GSK	7-172
S-23362	89437GSK	7-172
S-23566	89436GSK	7-172
S-24088	89436GSK	7-172
S-24125	89436GSK	7-172
S-26652	89436GSK	7-172
S-29432	89436GSK	7-172
S-4084	89430GSK	7-170
S-4089	89414GSK	7-170
HENDRICKSON TRUCK SUSPENSION SYSTEMS		
70018	89422GSK	7-174
70021	89422GSK	7-174

OEM Part No.	Part No.	Page No.
654890	89407GSK	7-174
654894	89405GSK	7-173
654898	89405GSK	7-173
654899	89414GSK	7-174
659004	89405GSK	7-173
671006	89405GSK	7-173
680091	89422GSK	7-174
5554596	89422GSK	7-174
47902-11	89407GSK	7-173
47902-13	89406GSK	7-173
47902-18	89440GSK	7-174
47902-19	89405GSK	7-173
47902-27	89405GSK	7-173
47902-28	89414GSK	7-174
47902-3	89430GSK	7-174
47902-8	89406GSK	7-173
47902-9	89405GSK	7-173
503610C2	89407GSK	7-173
58913-003	89453GSK	7-174
58913-012	89453GSK	7-174
59057-002	89405GSK	7-173
60665-004	89405GSK	7-173
60670-001	89405GSK	7-173
60670-002	89407GSK	7-174
60670-004	89405GSK	7-173
60670-008	89405GSK	7-173
60670-009	89414GSK	7-174
64838-001	89454GSK	7-174
64838-002	89454GSK	7-174
BE76164-2	89422GSK	7-174
HIGHWAY PRODUCT		
A1-6-134	89407GSK	7-174
A1-6-135	89436GSK	7-174
HINO		
48500-3710	89430GSK	7-174

OEM Part No.	Part No.	Page No.
485003710A	89430GSK	7-186
S4850-03710	89430GSK	7-175
HOBBS TRAILERS		
680117	89419GSK	7-175
HUTCHENS SUSPENSION		
9423-00	89436GSK	7-175
INTERNATIONAL (NAVISTAR)		
90044025	89414GSK	7-183
90044626	89430GSK	7-188
0 350425C1	89419GSK	n/a
0 462557C91	89419GSK	n/a
1663606C91	89418GSK	7-183
1664788C2	89426GSK	7-186
1667520C1	89431GSK	7-188
1675455C1	89411GSK	7-176
1677707C1	89440GSK	7-188
1690035C1	89411GSK	7-177
2015556C1	89426GSK	7-186
2015557C1	89440GSK	7-189
2018987C1	89411GSK	7-178
2029200C91	89430GSK	7-191
2032533C1	89426GSK	7-191
210920R91	89422GSK	7-187
3000070C91	89447GSK	7-193
306444C91	89413GSK	7-180
308646C91	89413GSK	7-180
308668C92	89413GSK	7-180
308669C91	89413GSK	7-180
320444C91	89413GSK	7-180
329316C92	89413GSK	7-180
350425C1	89419GSK	7-183
3549099C1	89458GSK	7-192
3549099C2	89458GSK	7-192
3571711C1	89426GSK	7-187
3573265C1	89458GSK	7-192
3581106C1	89457GSK	7-191

OEM Part No.	Part No.	Page No.
3581106C2	89457GSK	7-192
3581106C3	89457GSK	7-192
3581107C1	89457GSK	7-192
3581107C2	89457GSK	7-192
3581107C3	89457GSK	7-192
3581109C1	89457GSK	7-192
3581109C3	89457GSK	7-192
3581109C4	89457GSK	7-192
3584535C1	89457GSK	7-192
3584535C3	89457GSK	7-192
3586883C1	89458GSK	7-192
360444C91	89413GSK	7-181
3620395C1	89458GSK	7-192
426744R91	89422GSK	7-184
426744R92	89422GSK	7-184
453556C91	89413GSK	7-181
453564C91	89413GSK	7-181
453572C91	89446GSK	7-189
453576C91	89422GSK	7-184
453576C92	89422GSK	7-185
453577C91	89422GSK	7-185
453579C91	89422GSK	7-186
462557C91	89419GSK	7-183
467983C91	89413GSK	7-181
467985C91	89413GSK	7-182
471201C91	89413GSK	7-182
472411C91	89447GSK	7-189
472412C91	89447GSK	7-190
477132C1	89422GSK	7-186
501553C91	89411GSK	7-179
503550C1	89407GSK	7-176
503610C1	89407GSK	7-176
503610C2	89407GSK	7-176
507202C1	89440GSK	7-189
537524C91	89405GSK	7-176
537525C91	89405GSK	7-176
56101 Z1030	89424GSK	7-186

OEM Part No.	Part No.	Page No.
56101 Z2000	89424GSK	7-186
586724C91	89447GSK	7-190
790335C91	89414GSK	7-182
874695R91	89413GSK	7-182
874695R92	89413GSK	7-182
874696R91	89413GSK	7-182
AMS 600102	89430GSK	7-188
AMS 600172	89440GSK	7-189
AMS 650420	89414GSK	7-183
AMS650420	89414GSK	7-183

ISUZU

12474915	89406GSK	7-192
51630666	89413GSK	7-192
8-51630-666-0	89413GSK	7-192
9-51630-666-0	89413GSK	7-192
9-51630-666-2	89413GSK	7-193

KENWORTH

665092	89409GSK	7-193
665118	89409GSK	7-193
665453	89410GSK	7-194
665565	89412GSK	7-196
665670	89410GSK	7-194
665680	89409GSK	7-193
665828	89451GSK	7-198
665858	89459GSK	7-199
671962	89456GSK	7-199
675122	89410GSK	7-194
680475	89425GSK	7-198
680476	89423GSK	7-196
680486	89423GSK	7-196
680586	89424GSK	7-198
90044089	89407GSK	7-193
19495-01	89440GSK	7-198
47902-19	89405GSK	7-193
60670-008	89405GSK	7-193

OEM Part No.	Part No.	Page No.
B71-6004	89460GSK	7-199
B71-6005	89460GSK	7-199
B71-6006	89460GSK	7-199
C71-1002	89451GSK	7-198
C71-1011	89455GSK	7-199
K374-11	89410GSK	7-195
K374-14	89409GSK	7-193
K374-16	89410GSK	7-199
K374-26	89410GSK	7-199
K374-27	89410GSK	7-196
K374-28	89425GSK	7-198
K374-29	89423GSK	7-196
K374-3	89409GSK	7-198
K374-3-1	89409GSK	7-198
K374-32	89423GSK	7-196
K374-33	89409GSK	7-198
K374-4	89425GSK	7-198
K374-5	89409GSK	7-198
K374-7	89423GSK	7-193
K374-9	89423GSK	7-198
K374-C31	89409GSK	7-198
K374-C7	89423GSK	7-198
S-20126	89436GSK	7-198
LODAL, INC.		
9960257	89406GSK	7-200
MACK		
70042	89420GSK	7-201
651103	89405GSK	7-200
651151	89414GSK	7-201
5533699	89420GSK	7-201
5554184	89420GSK	7-201
20513881	89450GSK	7-202
20897198	89450GSK	7-202
20973993	89450GSK	7-202
141700000000	89450GSK	7-202
471700000000	89450GSK	7-202
14QK-1200P4	89407GSK	7-200

OEM Part No.	Part No.	Page No.
14QK-143	89407GSK	7-200
14QK-20001P2	89422GSK	7-201
14QK-2100D-P4	89407GSK	7-200
14QK-2100P2	89414GSK	7-201
14QK-2100P3	89407GSK	7-200
14QK-2100P4	89407GSK	7-200
14QK-2100P6	89405GSK	7-200
14QK-2105	89414GSK	7-201
14QK-2108	89436GSK	7-202
14QK-2113	89410GSK	7-201
14QK-2113M	89410GSK	7-201
14QK-2113P3	89410GSK	7-201
14QK-2113P4	89412GSK	7-201
14QK-2113P5	89410GSK	7-201
14QK-2113P6	89412GSK	7-201
14QK-2133M	89410GSK	7-201
14QK-2133M2	89410GSK	7-201
14QK-2136M	89450GSK	7-202
14QK-29001P2	89422GSK	7-201
14QK-29301P1	89407GSK	7-201
14QK-29301P2	89407GSK	7-201
14QK-29302	89407GSK	7-201
14QK-29302P1	89407GSK	7-201
14QK-3101M	89448GSK	7-202
14QK-3107M	89450GSK	7-202
14QK-3114M	89450GSK	7-202
14QK-366	89405GSK	7-200
14QK-366P1	89405GSK	7-200
14QK-366P2	89405GSK	7-200
14QK-366P3	89405GSK	7-200
14QK-366P4	89414GSK	7-201
14QK-372M2	89414GSK	7-201
14QK-372M3	89406GSK	7-200
14QK-375M	89405GSK	7-200
14QK-392AM	89430GSK	7-201
14QK-392AM2	89405GSK	7-200
14QK-392AM3	89430GSK	7-202

OEM Part No.	Part No.	Page No.
14QK-392BM	89430GSK	7-202
14QK-392BM3	89430GSK	7-202
14QK-392M	89430GSK	7-202
14QK-393AM	89405GSK	7-200
14QK-396	89430GSK	7-202
14QK-396M	89430GSK	7-202
14QK-422M	89454GSK	7-202
14QK-431M	89450GSK	7-202
47902-9	89405GSK	7-200
64838-002	89454GSK	7-202
SDA14170000380	89450GSK	7-202
SDA471700000431	89448GSK	7-202
MAECO		
6025	89406GSK	7-203
12866	89407GSK	7-203
70018	89422GSK	7-203
70021	89422GSK	7-203
70029	89422GSK	7-203
70034	89420GSK	7-203
70039	89422GSK	7-203
70042	89420GSK	7-203
70127	89401GSK	7-203
70128	89401GSK	7-203
70163	89420GSK	7-203
70300	89429GSK	7-203
70312	89410GSK	7-203
70317	89432GSK	7-203
70331	89425GSK	7-203
70334	89426GSK	7-203
70652	89440GSK	7-203
70663	89414GSK	7-203
74039	89422GSK	7-203
1668722	89440GSK	7-203
MARMON		
576451	89406GSK	7-203
37-1-1	89406GSK	7-203

OEM Part No.	Part No.	Page No.
51-139-28	89411GSK	7-203
51-163-7	89405GSK	7-203
MATSON SCHOOL BUS		
5392387	89422GSK	7-204
MITSUBISHI-FUSO		
MC813135	89447GSK	7-204
MOHAWK		
20273544	89436GSK	7-204
01-0100-905	89422GSK	7-204
MM-6886	89407GSK	7-204
MM-74029	89422GSK	7-204
MOTOR COACH INDUSTRIES		
12T-1-13	89422GSK	7-204
12TA-01-013	89422GSK	7-205
T14-1048	89420GSK	7-204
MUNCIE RECLAMATION		
MR1763	89419GSK	7-205
MR3306	89447GSK	7-205
NATIONAL COACH CORP		
C800853	89407GSK	7-205
NEOPLAN BUS		
680307	89447GSK	7-205
25-1700-101-426	89447GSK	7-205
AA1002002	89447GSK	7-206
AA1002003	89447GSK	7-206
AA1802002	89447GSK	7-206
AC1002002	89447GSK	7-206
AC1002003	89447GSK	7-206
CI 1002003	89447GSK	7-206
CL1002003	89447GSK	7-206
DT1802002	89447GSK	7-206
DZ1002002	89447GSK	7-206
GJ1002003	89447GSK	7-206

OEM Part No.	Part No.	Page No.
MM1002002	89447GSK	7-206
MM1002003	89447GSK	7-206
ORION BUS INDUSTRIES		
680091	89422GSK	7-206
20273541	89436GSK	7-206
20273544	89436GSK	7-206
010234503-4	89422GSK	7-206
020273541-4	89436GSK	7-206
OSHKOSH MOTORS		
665040	89422GSK	7-207
665060	89406GSK	7-207
690049	89422GSK	7-207
1445910	89419GSK	7-207
1573270	89407GSK	7-207
2173340	89422GSK	7-207
5353054	89422GSK	7-207
12405F-1	89422GSK	7-207
12405FX1	89422GSK	7-207
26228-A	89406GSK	7-207
40-0242	89409GSK	7-207
40-4951	89426GSK	7-207
40-5348	89431GSK	7-207
40-6967	89440GSK	7-207
OSTERLUND TRUCK		
680117	89419GSK	7-207
OTTAWA TRUCK		
680117	89419GSK	7-207
9007342	89422GSK	7-208
53540451	89419GSK	7-207
90013787	89423GSK	7-208
PACIFIC TRUCK AND TRAILER		
507202CI	89440GSK	7-208
PAGE SUSPENSION		
665133	89436GSK	7-208
1080099	89436GSK	7-208

OEM Part No.	Part No.	Page No.
PETERBILT		
665133	89436GSK	7-216
665633	89427GSK	7-216
665655	89408GSK	7-210
665656	89413GSK	7-212
665657	89414GSK	7-213
665658	89405GSK	7-209
665660	89427GSK	7-216
665662	89413GSK	7-216
665752	89451GSK	7-216
665762	89413GSK	7-216
665826	89455GSK	7-218
671091	89455GSK	7-218
671092	89413GSK	7-212
680026	89420GSK	7-213
680027	89422GSK	7-213
680185	89422GSK	7-214
680348	89413GSK	7-212
680435	89427GSK	7-216
680457	89420GSK	7-217
680459	89424GSK	7-215
680586	89424GSK	7-215
02-00376	89420GSK	7-217
02-00495	89420GSK	7-217
02-01787	89408GSK	7-209
02-01890	89413GSK	7-214
02-02061	89414GSK	7-216
02-02142	89405GSK	7-212
02-02225	89413GSK	7-214
02-02736	89420GSK	7-217
02-02737	89408GSK	7-209
02-02738	89413GSK	7-210
02-02739	89414GSK	7-212
02-02740	89405GSK	7-208,7-209
02-02741	89413GSK	7-211,7-212
02-02742	89408GSK	7-210

OEM Part No.	Part No.	Page No.
02-04010	89413GSK	7-212
03-01635	89422GSK	7-217
03-04176	89422GSK	7-213
03-04629	89424GSK	7-214
03-05106	89427GSK	7-215
03-05384	89427GSK	7-215
03-06084	89427GSK	7-215
03-07281	89424GSK	7-214
03-07421	89424GSK	7-214
03-07423	89427GSK	7-215
03-07424	89424GSK	7-215
03-08781	89455GSK	7-217
12887-01	89414GSK	7-217
12887-02	89414GSK	7-217
23-08233	89422GSK	7-214
23-10393	89422GSK	7-214
23-12262	89413GSK	7-212
B71-6002	89413GSK	7-212
B71-6005	89460GSK	7-214
C71-1002	89451GSK	7-212
C71-1011	89455GSK	7-218
C71-6000	89451GSK	7-216,7-217
PIERCE MANUFACTURING INC.		
1445910	89419GSK	7-219
40-0242	89409GSK	7-219
40-4951	89426GSK	7-219
40-5348	89431GSK	7-219
40-6967	89440GSK	7-219
PREVOST		
74939852	89422GSK	7-219
01-0100-905	89422GSK	7-219
12T-1-13	89422GSK	7-219
REYCO SUSPENSION		
12885-01	89419GSK	7-220
12885-03	89419GSK	7-220

OEM Part No.	Part No.	Page No.
12887-01	89414GSK	7-215
12887-02	89414GSK	7-220
17142-01	89410GSK	7-219
17146-01	89414GSK	7-220
17358-01	89440GSK	7-220
17403-01	89411GSK	7-219
17408-01	89430GSK	7-220
18163-01	89407GSK	7-219
18164-01	89406GSK	7-219
18800-01	89436GSK	7-220
19495-01	89440GSK	7-220
19623-01	89405GSK	7-219
20125-01	89440GSK	7-220
21497-01	89430GSK	7-220
700098-01	89436GSK	7-220

RIDEWELL CORPORATION

57645	89430GSK	7-221
665198	89430GSK	7-221
1250563B000	89436GSK	7-221
1253069B000	89430GSK	7-220
1267395B000	89420GSK	7-220
1270563B000	89436GSK	7-221
1275943B	89430GSK	7-221
AS30698	89430GSK	7-221
AS3069B	89430GSK	7-221
AS563B	89436GSK	7-221
AS575B	89430GSK	7-221
S5878B	89407GSK	7-220
S6009B	89436GSK	7-221
S7172B	89407GSK	7-220

SAF HOLLAND

6025	89406GSK	7-222
57639	89436GSK	7-224
57643	89414GSK	7-223
665003	89419GSK	7-223
680268	89436GSK	7-224

OEM Part No.	Part No.	Page No.
90044001	89430GSK	7-223
90044008	89436GSK	7-224
90044016	89419GSK	7-223
90044025	89414GSK	7-223
90044046	89405GSK	7-226
90044071	89436GSK	7-224
90044081	89436GSK	7-224
90044086	89436GSK	7-224
90044089	89407GSK	7-226
90044095	89436GSK	7-224
90044626	89430GSK	7-223
90044679	89406GSK	7-222
90044682	89414GSK	7-223
90044683	89406GSK	7-222
90044684	89407GSK	7-222
90044688	89406GSK	7-222
90044769	89407GSK	7-222
90044770	89407GSK	7-222
90044981	89436GSK	7-224
90044982	89436GSK	7-224
90044991	89436GSK	7-224
90044992	89436GSK	7-224
90045001	89436GSK	7-224
90045003	89436GSK	7-224
90045299	89436GSK	7-224
90044089C	89407GSK	7-222
AR-1202	89419GSK	7-223
AR-134-C	89430GSK	7-224
AR-1434	89436GSK	7-224
AR-1654	89414GSK	7-223
AR-2451	89436GSK	7-224
AR-2598	89405GSK	7-222
AR-718-C	89436GSK	7-224
AR-718-C-HD	89436GSK	7-224
AR-781	89436GSK	7-224
AR-958	89407GSK	7-223

OEM Part No.	Part No.	Page No.
SPARTAN MOTORS		
0346-SS5	89414GSK	7-225
B46-1594	89414GSK	7-225
STERLING TRUCK		
680611	89443GSK	7-227
16-15817-000	89443GSK	7-227
16-18708-000	89443GSK	7-227
47902-28	89414GSK	7-225
58913-003	89453GSK	7-228
AX267A	89446GSK	7-227
C4HZ-18124-E	89446GSK	7-227
E9HZ-18124-A	89446GSK	7-227
F1HZ-18124-A	89446GSK	7-228
F1HZ-18124-D	89401GSK	7-225
F1HZ-18124-E	89401GSK	7-225
F1HZ-18124-K	89402GSK	7-225
F5HZ-18125-A	89425GSK	7-225
F5HZ-18125-B	89410GSK	7-225
F6HT-18045-AA	89438GSK	7-226
F6HT-18045-AC	89438GSK	7-226
F6HT-18045-BC	89435GSK	7-226
F6HT-18045-CC	89439GSK	7-226
F6HT-18045-EB	89439GSK	7-227
F6HT-18045-EC	89439GSK	7-227
F6HT-18045-GC	89440GSK	7-227
F6HT-18045-HB	89438GSK	7-226
F6HT-18045-HC	89438GSK	7-226
F6HT-18080-CA	89425GSK	7-225
F6HT-18080-FC	89414GSK	7-225
F6HZ-18124-A	89438GSK	7-226
F6HZ-18124-C	89439GSK	7-227
F6HZ-18124-D	89439GSK	7-227
F6HZ-18124-E	89439GSK	7-227
F6HZ-18124-F	89439GSK	7-227
F6HZ-18124-G	89438GSK	7-226

OEM Part No.	Part No.	Page No.
F6HZ-18124-H	89438GSK	7-226
F6HZ-18125-D	89414GSK	7-225
SDA471700002809	89443GSK	7-227
XC45-18080-BA	89443GSK	7-227
STOUGHTON TRAILERS INC.		
HTA20001	89436GSK	7-228
HTA20002	89436GSK	7-228
THOMAS SCHOOL BUS		
61300224	89449GSK	7-228
61300240	89449GSK	7-228
61310102	89422GSK	7-228
61310103	89422GSK	7-228
61310232	89436GSK	7-228
61310434	89443GSK	7-228
61310478	89443GSK	7-228
10-13634-000	89449GSK	7-228
16-18708-000	89443GSK	7-228
16-19138-000	89431GSK	7-228
6130-0114	89437GSK	7-228
TRAILMOBILE CANADA CORP.		
90044089	89407GSK	7-229
90044992	89436GSK	7-229
43-4-237	89436GSK	7-229
43-4-239	89407GSK	7-229
43-4-277	89436GSK	7-229
43-6-028	89436GSK	7-229
43-6-118	89436GSK	7-229
43-6-158	89414GSK	7-229
43-6-164	89407GSK	7-229
43-8-002	89414GSK	7-229
43-8-011	89407GSK	7-229
43-8-013	89436GSK	7-229
43-8-014	89414GSK	7-229
TRANSPORTATION MFG. CORP.		
12TA-01-13	89422GSK	7-229

OEM Part No.	Part No.	Page No.
TWIN COACH		
90044089	89407GSK	7-230
90044089C	89407GSK	7-230
AR-718-C-HD	89436GSK	7-230
AR-958	89407GSK	7-230
VOLVO		
70042	89420GSK	7-231
530596	89422GSK	7-231
665410	89418GSK	7-231
665539	89417GSK	7-231
665607	89435GSK	7-232
665623	89434GSK	7-231
665739	89435GSK	7-232
1091348	89406GSK	7-230
1091350	89407GSK	7-230
1091351	89414GSK	7-230
1091358	89447GSK	7-232
1091359	89405GSK	7-230
1091362	89446GSK	7-232
1091364	89409GSK	7-230
1091367	89436GSK	7-232
1091368	89411GSK	7-230
1091371	89419GSK	7-231
1091373	89420GSK	7-231
1091374	89422GSK	7-231
1091378	89422GSK	7-231
1091379	89423GSK	7-231
1093100	89418GSK	7-231
1093176	89416GSK	7-230
1093178	89417GSK	7-231
1093180	89440GSK	7-232
3092842	89450GSK	7-237
3172948	89422GSK	7-231
3915917	89428GSK	7-231
3915947	89410GSK	7-230

OEM Part No.	Part No.	Page No.
3915948	89424GSK	7-231
3916352	89414GSK	7-230
3919055	89412GSK	7-230
3919056	89436GSK	7-232
3919561	89425GSK	7-231
3919585	89414GSK	7-230
3919958	89434GSK	7-231
3949241	89450GSK	7-237
5534430	89422GSK	7-231
5534447	89422GSK	7-231
5549899	89407GSK	7-230
8026658	89434GSK	7-231
8056892	89415GSK	7-230
8065787	89417GSK	7-231
8071524	89416GSK	7-230
8078195	89450GSK	7-237
8086053	89435GSK	7-232
8086651	89448GSK	7-237
8169859	89435GSK	7-232
20433424	89450GSK	7-237
20433425	89448GSK	7-232
20485633	89454GSK	7-237
20513881	89450GSK	7-237
20551628	89448GSK	7-232
141700000443	89450GSK	7-233
471700000443	89448GSK	7-233
03-1106460	89430GSK	7-231
35901-0001	89414GSK	7-230
35901-0011	89405GSK	7-230
35901-3201	89416GSK	7-230
35901-3420	89422GSK	7-231
37301-0001	89414GSK	7-230
37301-0016	89417GSK	7-231
37301-0018	89430GSK	7-231
37301-0021	89417GSK	7-231
37301-3201	89418GSK	7-231
37301-3202	89417GSK	7-231

OEM Part No.	Part No.	Page No.
64838-001	89454GSK	7-233
64838-002	89454GSK	7-233
8077874-P01	89435GSK	7-232
VOLVO-AUTOCAR		
8026658	89434GSK	7-234
8071524	89416GSK	7-234
03-1106460	89430GSK	7-234
35901-3201	89416GSK	7-234
37301-3201	89418GSK	7-234
37301-3202	89417GSK	7-234
WABASH NATIONAL		
FLL83203-07I	89436GSK	7-234
FLL85000-07I	89436GSK	7-234
FRUUCE1295-1	89419GSK	7-234
FRUUCE1295-901	89419GSK	7-234
HENS-20001	89436GSK	7-234
HENS-20002	89436GSK	7-234
HENS-20126	89436GSK	7-234
HENS-23566	89436GSK	7-234
HENS-24088	89436GSK	7-234
NEW900-44-089	89407GSK	7-234
NEW900-44-626	89430GSK	7-234
NEW900-45-299	89436GSK	7-234
WATSON & CHALIN MFG. INC.		
10147	89436GSK	7-235
11724	89405GSK	7-235
12128	89430GSK	7-235
17079	89419GSK	7-235
17186	89436GSK	7-235
665724	89436GSK	7-235
665727	89430GSK	7-235
665862	89436GSK	7-235
680547	89436GSK	7-235
727603	89436GSK	7-235
10147HD	89436GSK	7-235
17186-01	89436GSK	7-235

OEM Part No.	Part No.	Page No.
WESTERN STAR		
665682	89442GSK	7-238
90044025	89414GSK	7-236
35066-4413	89406GSK	7-236
35901-0001	89414GSK	7-236
35901-3420	89422GSK	7-236
37301-3401	89442GSK	7-236
37301-3404	89442GSK	7-237
37301-3405	89442GSK	7-237
37301-3409	89442GSK	7-237
37301-3412	89442GSK	7-237
37390-4401	89442GSK	7-237
37390-4402	89442GSK	7-237
37390-4403	89442GSK	7-238
47902-13	89406GSK	7-236
47902-8	89406GSK	7-236
58913-003	89453GSK	7-238
58913-012	89453GSK	7-238
WESTERN UNIT "STABILAIRES" SUSPENSION		
80600	89419GSK	7-238
4939967	89422GSK	7-238



HEIGHT CONTROL VALVES



Shear seal design

FEATURES & BENEFITS

- » Patented technology resists contamination and freeze-up
- » High airflow dual port design for faster height response
- » Minimal re-plumbing and no routing for easy bolt-on installation

RELATED PARTS

- » Shocks should be replaced when replacing a HCV
- » Inspect all air springs, bushings and torque rods when replacing a HCV

HEIGHT CONTROL VALVES

TRP® Height Control Valves are manufactured with the patented Shear-Seal design, resulting in reliable rotors that resist contamination and freeze-up. The Shear-Seal design was created for use on air suspensions in the oil patch, where abusive conditions shorten height control valve life. The TRP® Height Control Valve design feature two precisely-machined sliding metal surfaces for a leak-free seal and a proportional response for precise ride control.

Easy bolt on installation to existing brackets requires minimal re-plumbing, without the need to route air lines.



Scan the code for more information.
Get the free mobile app at <http://gettag.mobi>

HEIGHT CONTROL VALVE

HEIGHT CONTROL VALVE ASSEMBLY



Table 7-151: Suspension & Ride Control - Height Control Valve Assembly

Part No.	Description
WITH DUMP VALVE	
HV9990	Height Control Valve Assembly with Dump Valve
HV-UN007	Height Control Valve Assembly with Dump Valve
HV-UN1PACDUMP	Height Control Valve Assembly with Dump Valve
WITHOUT DUMP VALVE	
HV2454	Height Control Valve Assembly without Dump Valve
HV9980	Height Control Valve Assembly without Dump Valve
HV9985	Height Control Valve Assembly without Dump Valve
HV9995	Height Control Valve Assembly without Dump Valve
HV9998	Height Control Valve Assembly without Dump Valve
HV-UN1PAC	Height Control Valve Assembly without Dump Valve
HV-WBCAB	Height Control Valve Assembly without Dump Valve
HV-WBSUSP	Height Control Valve Assembly without Dump Valve

CROSS REFERENCE FOR HEIGHT CONTROL VALVE ASSEMBLY

CROSS REFERENCE FOR HEIGHT CONTROL VALVE ASSEMBLY

Table 7-152: Cross Reference for Height Control Valve

TRP®	Wabco	Haldex	Euclid	Midland	Hadley
HV-WBSUSP	S464-002-443-0	90554241	E4350	KN27000	
HV-UN1PAC		90054007			H00450CE
HV-WBCAB	S464-007-004-0				
HV-UN1PACDUMP		90054007 / 90554334 (with dump)			H00450CE
HV-UN007		90054007			



LEAF SPRINGS



FEATURES & BENEFITS

- » Springs are heat treated for strength and long life
- » Special coating is applied on springs for extended rust resistance
- » Meets or exceeds SAE J1528 testing requirements for fatigue and stiffness
- » Certified TS16949 for quality assurance

RELATED PARTS

- » Suspension parts
- » Shock absorbers
- » Height control valves

LEAF SPRINGS

The TRP Trailer leaf spring is made up of multiple spring steel leaves that support the vehicle or trailer weight, absorb bumps and locate the axle to the vehicle or trailer.

The TRP® program provides a “full taper” style of leaf spring. This style uses two to four spring steel leaves of varying thicknesses. Each leaf is approximately the same length.

As leaf springs age, they tend to lose strength and cause the vehicle to sag. Inspect the vehicle or trailer for proper ride height or for badly corroded or cracked leaves. If a spring or leaf is damaged, replace both spring assemblies in pairs.

CROSS REFERENCE

TRP®	Application
LS2726	3 Leaf High 6" Arch
LS2727	3 Leaf Medium 4.5" Arch
LS2728	3 Leaf Low 3 5/8" Arch

RECOMMENDED GRADE 8 U-BOLT KITS

Meritor	Bolt Length	Bolt Width
R30U816114	14"	3"
R30U816116	16"	3"
R30U816514	14"	5"
R30U816516	16"	5"

Scan the code for more information.
Get the free mobile app at <http://gettag.mobi>



TRAILER LEAF SPRINGS

TRAILER LEAF SPRINGS



Table 7-153: Suspension & Ride Control - Trailer Leaf Springs

Part No.	Application	Hutchens Part No.	TRA Part No.	U-Bolt Kit No.
LS2726	Spring - 3 Leaf High 6" Arch	354-00	TRA2726	R30U816116
LS2727	Spring - 3 Leaf Medium 4.5" Arch	355-00	TRA2727	R30U816116
LS2728	Spring - 3 Leaf Low 3-5/8" Arch	356-00	TRA2728	R30U816116



WHEELS

ALUMINUM WHEELS

Extensive testing has proven that aluminum wheels increase overall fuel efficiency as well as lower maintenance costs. Compared to steel wheels, TRP® Aluminum Wheels can reduce truck and trailer weight by several hundred pounds. The cooler running wheels improve tire and brake life and decrease maintenance costs.



FEATURES & BENEFITS

- " Lighter weight wheels increase overall fuel efficiency
- " Cooler running wheels improve both tire and brake life
- " Lower overall maintenance costs
- " 3 year warranty

RELATED PARTS

- " Brake drums
- " Brakes
- " Wheel seals
- " Wheel bearings



WHEEL SPECIFICATIONS

TRP®	Size	Finish	Hand Holes	Bolt Circle	Weight
AW2258M	22.5 x 8.25	Machine	10	285.75 mm	52 lbs.
AW2258B	22.5 x 8.25	Polish both sides	10	285.75 mm	52 lbs.
AW2458M	24.5 x 8.25	Machine	10	285.75 mm	63 lbs.
AW2458B	24.5 x 8.25	Polish both sides	10	285.75 mm	63 lbs.
AW2258M335	22.5 x 8.25	Machine	10	335 mm	52 lbs.

CROSS REFERENCE

TRP®	Alcoa	Accuride
AW2258M	883677	41644ANP
AW2258B	883673	41644XP
AW2458M	983677	29362ANP
AW2458M	983673	29362ABP
AW2258M335	886520	29560ANP

Scan the code for more information.
Get the free mobile app at <http://gettag.mobi>





WHEELS

STEEL WHEELS

TRP® steel wheels provide an outstanding combination of strength and value. Whether your application is for truck, trailer or school bus, TRP® will have a steel wheel that is right for you. Tubeless disc wheels provide your customers with the wheel strength they need for any job.

- Available in 22.5" x 8.25" and 24.5" x 8.25"
- White E-Coat
- 2 Hand Hole



FEATURES & BENEFITS

- » High strength spun center disc & steel for quality & durability
- » Meets all SAE J267 requirements
- » Available in both 22.5" and 24.5"
- » 1 year warranty

RELATED PARTS

- » Brake drums
- » Brakes
- » Wheel seals
- » Wheel bearings



WHEEL SPECIFICATIONS

TRP®	Size	Pilot	Load Rating	Hand Holes	Bolt Circle	Weight
SW2257H	22.5 x 8.25	Hub	7,400 lbs	2	285.75mm	83 lbs.
SW2457H	24.5 x 8.25	Hub	7,400 lbs	2	285.75mm	95 lbs.
SW2458H	24.5 x 8.25	Hub	8,000 lbs	2	285.75mm	108 lbs.

CROSS REFERENCE

TRP®	Size	Popular Equivalent
SW2257H	22.5" x 8.25"	50307PW
SW2457H	24.5" x 8.25"	50379PW
SW2458H	24.5" x 8.25"	28827PW

Scan the code for more information.
Get the free mobile app at <http://gettag.mobi>



WHEEL END

Wheel Seals
See Page 7-299



ALUMINUM WHEELS



Table 7-154: Wheel End - Aluminum Wheels

Part No.	Size	Finish	Hand Holes	Bolt Circle	Weight
AW2258M	22.5" x 8.25"	Machined	10	285.75mm	52 lbs.
AW2258B	22.5" x 8.25"	Polished, both sides	10	285.75mm	52 lbs.
AW2258M335	22.5" x 8.25"	Machined	10	335mm	52 lbs.
AW2458M	24.5" x 8.25"	Machined	10	285.75mm	63 lbs.
AW2458B	24.5" x 8.25"	Polished, both sides	10	285.75mm	63 lbs.

STEEL WHEELS



Table 7-155: Wheel End - Steel Wheels

Part No.	Size	Pilot	Hand Holes	Load Rating	Bolt Circle	Weight
SW2257H	22.5" x 8.25"	Hub	2	7,400 lbs	285.75mm	83 lbs.
SW2457H	24.5" x 8.25"	Hub	2	7,400 lbs	285.75mm	95 lbs.
SW2458H	24.5" x 8.25"	Hub	2	8,000 lbs	285.75mm	108 lbs.



BEARINGS



WHEEL BEARINGS

The TRP® wheel program offers the most popular wheel bearings for truck and trailer applications. From single piece cups and cones to complete sets, TRP® Wheel Bearings are manufactured with the highest quality steel and meet TS-16949 standards. Raceways are precisely crowned and then super-finished to a mirror-like gloss.

POPULAR TRAILER APPLICATIONS

TRP®	Components
BWSET413	BWHM212049 and BWHM212011
BWSET414	BWHM218248 and BWHM218210
BWSET415	BWHM518445 and BWHM518410

FEATURES & BENEFITS

- » Superb rib finishing permits less wear on rollers for longer bearing life
- » Perfect contours of matching surfaces ensures no end loading of rollers
- » Vacuum degassed 52100 bearing steel ensures durability
- » Each bearing is inspected to the zero defect level

RELATED PARTS

- » Wheel Seals
- » Hubs
- » Drums
- » Brake Shoes
- » Camshafts

POPULAR TRUCK APPLICATIONS

TRP®	Components
BWSET401	BW580 and BW572
BWSET403	BW594A and BW592A
BWSET406	BW3782 and BW3720

CROSS REFERENCE

TRP®	Timken	NTN
BWSET401	SET401TRB	SET401NTN
BWSET403	SET403TRB	SET403NTN
BWSET406	SET406TRB	SET406NTN
BWSET413	SET413TRB	SET413NTN
BWSET414	SET414TRB	SET414NTN
BWSET415	SET415TRB	SET415NTN



Scan the code for more information.
Get the free mobile app at <http://gettag.mobi>

WHEEL BEARINGS

TAPERED ROLLER BEARING CONES

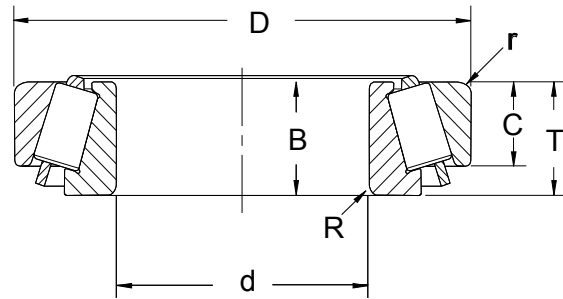

Table 7-156: Wheel End - Wheel Bearings

Part No.	Included in Set	Bore	Width (B)	Fillet (R)
BW3782	BWSET406	1.7500" (44.450mm)	1.1930" (30.302mm)	0.14" (3.5mm)
BW555S	BWSET424	2.2500" (57.150mm)	1.4440" (36.678mm)	0.14" (3.5mm)
BW39590	—	2.6250" (66.675mm)	1.1875" (30.162mm)	0.14" (3.5mm)
BWHM212049	BWSET413	2.6250" (66.675mm)	1.5100" (38.354mm)	0.14" (3.5mm)
BW580	BWSET401	3.2500" (82.550mm)	1.4212" (36.098mm)	0.14" (3.5mm)
BW663	BWSET405	3.2500" (82.550mm)	1.6250" (41.275mm)	0.14" (3.5mm)
BW594	—	3.7500" (95.250mm)	1.4300" (36.322mm)	0.14" (3.5mm)
BW594A	BWSET403	3.7500" (95.250mm)	1.4300" (36.322mm)	0.20" (4.0mm)
BWHM518445	BWSET415	3.5000" (88.900mm)	1.5625" (39.688mm)	0.25" (6.4mm)
BW598A	BWSET404	3.6250" (92.075mm)	1.4300" (36.322mm)	0.25" (6.4mm)
BWHM212047	—	2.5000" (63.500mm)	1.5100" (38.354mm)	0.28" (7.0mm)
BWHM218248	BWSET414	3.5423" (89.974mm)	1.5748" (40.000mm)	0.28" (7.0mm)
BW6461A	BWSET423	3.0000" (76.200mm)	2.1350" (54.229mm)	0.38" (9.7mm)

TAPERED ROLLER BEARING CUPS

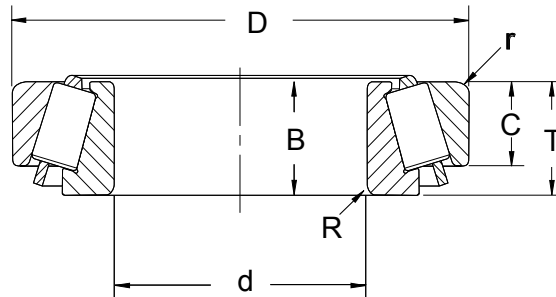

Table 7-157: Wheel End - Tapered Roller Bearing Cups

Part No.	Included in Set	O.D. (D)	Width (C)	Fillet (r)	Width (T)
BW3720	BWSET406	3.6718" (93.264mm)	0.9375" (23.812mm)	0.13" (3.3mm)	1.1875" (30.162mm)
BW29620	—	4.4375" (112.712mm)	0.7500" (19.050mm)	0.13" (3.3mm)	1.0000" (25.400mm)
BW39520	—	4.4375" (112.712mm)	0.9375" (23.812mm)	0.13" (3.3mm)	1.1875" (30.162mm)
BWHM212011	BWSET413	4.8125" (122.238mm)	1.1700" (29.718mm)	0.13" (3.3mm)	1.5000" (38.100mm)
BW552A	BWSET424	4.8750" (123.825mm)	1.1875" (30.162mm)	0.13" (3.3mm)	1.5000" (38.100mm)
BW572	BWSET401	5.5115" (139.992mm)	1.1250" (28.575mm)	0.13" (3.3mm)	1.4375" (36.513mm)
BW653	BWSET405	5.7500" (146.050mm)	1.2500" (31.750mm)	0.13" (3.3mm)	1.5000" (38.100mm)
BWHM218210	BWSET414	5.7864" (146.975mm)	1.2795" (32.500mm)	0.14" (3.5mm)	1.5748" (40.000mm)
BW6420	BWSET423	5.8750" (147.225mm)	1.7500" (44.450mm)	0.13" (3.3mm)	2.1250" (53.975mm)
BW592A	BWSET403, BWSET404	6.0000" (152.400mm)	1.1875" (30.162mm)	0.13" (3.3mm)	1.5625" (39.688mm)
BWHM518410	BWSET415	6.0000" (152.400mm)	1.1875" (30.162mm)	0.13" (3.3mm)	1.5625" (39.688mm)

TAPERED ROLLER BEARING SETS

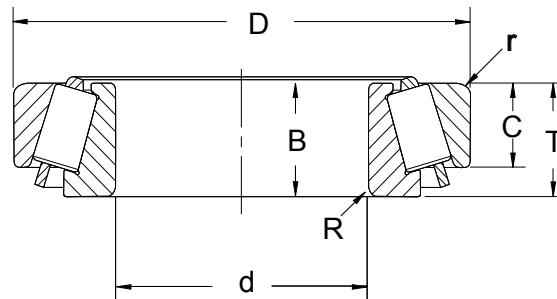

Table 7-158: Wheel End - Tapered Roller Bearing Sets

Part No.	Cone/Cup	Bore (d)	O.D. (D)	Width (B)	Width (C)	Fillet (R)	Fillet (r)	Width (T)
BWSET411	47686, 47620	3.2500" (82.550mm)	5.2500" (133.350mm)	1.3125" (33.338mm)	1.0313" (26.195mm)	0.14" (3.5mm)	0.13" (3.3mm)	1.3125" (33.338mm)
BWSET413	BWHM212049, BWHM212011	2.6250" (66.675mm)	4.8125" (122.238mm)	1.5100" (38.354mm)	1.1700" (29.718mm)	0.14" (3.5mm)	0.13" (3.3mm)	1.5000" (38.100mm)
BWSET414	BWHM218248, BWHM218210	3.5423" (89.974mm)	5.7864" (146.975mm)	1.5748" (40.000mm)	1.2795" (32.500mm)	0.28" (7.0mm)	0.14" (3.5mm)	1.5748" (40.000mm)
BWSET415	BWHM518445, BWHM518410	3.5000" (88.900mm)	6.0000" (152.400mm)	1.5625" (39.688mm)	1.1875" (30.162mm)	0.25" (6.4mm)	0.13" (3.3mm)	1.5625" (39.688mm)
BWSET424	BW555S, BW552A	2.2500" (57.150mm)	4.8750" (123.825mm)	1.4440" (36.678mm)	1.1875" (30.162mm)	0.14" (3.5mm)	0.13" (3.3mm)	1.5000" (38.100mm)
BWSET423	BW6461A, BW6420	3.0000" (76.200mm)	5.8750" (147.225mm)	2.1350" (54.229mm)	1.7500" (44.450mm)	0.38" (9.7mm)	0.13" (3.3mm)	2.1250" (53.975mm)
BWSET401	BW580/BW572	3.2500" (82.550mm)	5.5115" (139.992mm)	1.4212" (36.098mm)	1.1250" (28.575mm)	0.14" (3.5mm)	0.13" (3.3mm)	1.4375" (36.513mm)
BWSET403	BW594A/ BW592A	3.7500" (95.250mm)	6.0000" (152.400mm)	1.4300" (36.322mm)	1.1875" (30.162mm)	0.20" (4.0mm)	0.13" (3.3mm)	1.5625" (39.688mm)
BWSET404	BW598A/ BW592A	3.6250" (92.075mm)	6.0000" (152.400mm)	1.4300" (36.322mm)	1.1875" (30.162mm)	0.25" (6.4mm)	0.13" (3.3mm)	1.5625" (39.688mm)
BWSET405	BW663/BW653	3.2500" (82.550mm)	5.75" (146.050mm)	1.6250" (41.275mm)	1.2500" (31.750mm)	0.14" (3.5mm)	0.13" (3.3mm)	1.5000" (38.100mm)
BWSET406	BW3782/ BW3720	1.7500" (44.450mm)	3.6718" (93.264mm)	1.1930" (30.302mm)	0.9375" (23.812mm)	0.14" (3.5mm)	0.13" (3.3mm)	1.1875" (30.162mm)



WHEEL END PRODUCTS

FEATURES & BENEFITS

- » Higher grade materials allow for greater torque strength in the threads of the bolt.
- » Higher grade materials are best suited for heavy duty trucking applications where high stress and strong load bearing pressures are a major factor.
- » TRP® stocks over 150 parts in PDCs for fast inventory replenishment.
- » TRP® Wheel End covers truck and trailer applications for ease of ordering from one program.

RELATED PARTS

- » Brake Drums
- » Hubs
- » Brakes
- » Steel Wheels
- » Aluminum Wheels



WHEEL END PRODUCTS

The TRP® Wheel End Program covers over 150 of the most popular heavy duty and medium duty truck and trailer applications. From 2-piece flange capnuts, inner and outer capnuts to wheel studs, the TRP® program will have the wheel attaching hardware you need to complete the job. A complete list of industry cross references is available to confirm part number accuracy and eliminate the error of duplicate stock in inventory.

CROSS REFERENCE

TRP®	Inline	Euclid/Industry	Leland	Description
WE6000	TFZA017R	E-6000A	W498	NUT- FLANGE M22-1.5
WE5991	TFZA019R	E-5991	W492	NUT- FLANGE M22-1.5
WE4963	NRMA001R	E-4963	W8	NUT-RIM 3/4-10
WE5977R / L	TBWA015R / L	E-5977R / L	W13 / W14	NUT-OUTER WHEEL LH 1-1/8-16
WE7895R / L	TANW025R / L	E-7895R / L	W11 / W12	NUT- RH I-3/4-16 0-1-1/8-16 X 2-1/4"
WE7896R / L	TANW027R / L	E-7896R / L	W620 / W621	NUT- RH I-3/4-16 0-1-1/8-16 X 2-9/16"
WE5988R / L	TANW003R / L	E-5988R / L	W486 / W487	NUT- RH I-3/4-16 0-1-1/8-16 X 3-1/16"
WE7897R / L	TANW029R / L	E-7897R / L	W616 / W617	NUT- LH I-3/4-16 0-1-1/8-16 X 3-1/16"
WE10215	SZAR005R	E-10215	W716	STUD- WHEEL M22-1.5 x 4-3/32"
WE10221	SZAR003R	E-10221	W702	STUD- WHEEL M22-1.5 X 5-5/16"
WE8981	SZAW021R	E-8981 / W1164	W657	STUD- WHEEL M22-1.5 X 4"
WE1325	SZAW029R	W1325	W546	STUD- WHEEL M22-1.5 X 4-13/16"
WE4956	RMMA005R	E-4956A	W6	STUD-RIM 3/4-10 X 2-13/16" (1" AND 1-9/16")



Scan the code for more information.
Get the free mobile app at <http://gettag.mobi>

WHEEL END HARDWARE

DISC WHEEL STUDS (METRIC)

Table 7-159: Wheel End - Disc Wheel Studs (Metric)

Part No.	Description	Body Diameter	Type	Grade
WE5997	Metric Disc Wheel Stud M22-1-1/2" x 3-11/16"	.910-.899"	Disc Wheel	10.9
WE5998	Metric Disc Wheel Stud M22-1-1/2" x 3-3/16"	.910-.899"	Disc Wheel	10.9
WE5999	Metric Disc Wheel Stud M22-1-1/2" x 4-7/16"	.910-.899"	Disc Wheel	10.9

DISC WHEEL STUDS (SAE)



Table 7-160: Wheel End - Disc Wheel Studs (SAE)

Part No.	Description	Body Diameter	Type	Grade
WE5719L	Left Hand Disc Wheel Stud 3/4"-16 x 2-9/16"	.984 - .974"	Disc Wheel LH	8
WE5719R	Right Hand Disc Wheel Stud 3/4"-16 x 2-9/16"	.984 - .974"	Disc Wheel RH	8
WE5720L	Left Hand Disc Wheel Stud 3/4"-16 x 2-23/32"	.984 - .974"	Disc Wheel LH	8
WE5720R	Right Hand Disc Wheel Stud 3/4"-16 x 2-23/32"	.984 - .974"	Disc Wheel RH	8
WE5896L	Left Hand Disc Wheel Stud 3/4"-16 x 3-3/8"	.975 - .971"	Disc Wheel LH	8
WE5896R	Right Hand Disc Wheel Stud 3/4"-16 x 3-3/8"	.975 - .971"	Disc Wheel RH	8
WE5900L	Left Hand Disc Wheel Stud 3/4"-16 x 2-11/16"	.976 - .971"	Disc Wheel LH	8
WE5900R	Right Hand Disc Wheel Stud 3/4"-16 x 2-11/16"	.976 - .971"	Disc Wheel RH	8
WE5910L	Left Hand Disc Wheel Stud 3/4"-16 x 3-1/8"	.976 - .971"	Disc Wheel LH	8
WE5910R	Right Hand Disc Wheel Stud 3/4"-16 x 3-1/8"	.976 - .971"	Disc Wheel RH	8
WE5982L	Left Hand Disc Wheel Stud 1-1/8"-16 x 3-3/4"	1.222-1.218"	Disc Wheel LH	8
WE5982R	Right Hand Disc Wheel Stud 1-1/8"-16 x 3-3/4"	1.222-1.218"	Disc Wheel RH	8
WE5983L	Left Hand Disc Wheel Stud 3/4"-16 x 3-3/4"	.975 - .971"	Disc Wheel LH	8
WE5983R	Right Hand Disc Wheel Stud 3/4"-16 x 3-3/4"	.975 - .971"	Disc Wheel RH	8
WE5986L	Left Hand Disc Wheel Stud 1-1/8"-16 x 2-31/32"	1.222-1.218"	Disc Wheel LH	8
WE5986R	Right Hand Disc Wheel Stud 1-1/8"-16 x 2-31/32"	1.222-1.218"	Disc Wheel RH	8

Part No.	Description	Body Diameter	Type	Grade
WE8968L	Left Hand Disc Wheel Stud 3/4"-16 x 3-3/16"	.786 - .783"	Disc Wheel LH	8
WE8968R	Right Hand Disc Wheel Stud 3/4"-16 x 3-3/16"	.786 - .783"	Disc Wheel RH	8
WE8972L	Left Hand Disc Wheel Stud 1-1/8"-16 x 3-1/2"	1.222-1.218"	Disc Wheel LH	8
WE8972R	Right Hand Disc Wheel Stud 1-1/8"-16 x 3-1/2"	1.222-1.218"	Disc Wheel RH	8
WE8990L	Left Hand Disc Wheel Stud 1-1/8"-16 x 4"	1.222-1.218"	Disc Wheel LH	8
WE8990R	Right Hand Disc Wheel Stud 1-1/8"-16 x 4"	1.222-1.218"	Disc Wheel RH	8
WE9001L	Left Hand Disc Wheel Stud 1-1/8"-16 x 3-15/32"	1.222-1.218"	Disc Wheel LH	8
WE9001R	Right Hand Disc Wheel Stud 1-1/8"-16 x 3-15/32"	1.222-1.218"	Disc Wheel RH	8
WE10206L	Left Hand Disc Wheel Stud 3/4"-16 x 3"	.786 - .783"	Disc Wheel LH	8
WE10206R	Right Hand Disc Wheel Stud 3/4"-16 x 3"	.786 - .783"	Disc Wheel RH	8

WHEEL STUDS (METRIC)



WE6034



WE6036

Table 7-161: Wheel End - Wheel Studs (Metric)

Part No.	Description	Body Diameter	Type	Grade
WE1202	Metric Wheel Stud M22- 1-1/2" x 3-29/32"	1.222-1.218"	Wheel	10.9
WE1270	Metric Wheel Stud M22- 1-1/2" x 4-1/2"	.975-.971"	Wheel	10.9
WE1325	Metric Wheel Stud M22- 1-1/2" x 4-13/16"	n/a	Wheel	10.9
WE6034	Metric Wheel Stud M22- 1-1/2" x 4-13/16"	.977-.973"	Wheel	10.9
WE6035	Metric Wheel Stud M22- 1-1/2" x 3-15/16"	.977-.973"	Wheel	10.9
WE6036	Metric Wheel Stud M22- 1-1/2" x 3-1/2"	.977-.973"	Wheel	10.9
WE8981	Metric Wheel Stud M22- 1-1/2" x 4"	.975-.971"	Wheel	10.9
WE8987	Metric Wheel Stud M22- 1-1/2" x 5-3/16"	.975-.971"	Wheel	10.9
WE8988	Metric Wheel Stud M22- 1-1/2" x 3-23/32"	n/a	Wheel	10.9
WE10215	Metric Wheel Stud M22- 1-1/2" x 4-3/32"	.912-.908"	Wheel	10.9
WE10217	Metric Wheel Stud M22- 1-1/2" x 4-15/16"	.912-.908"	Wheel	10.9
WE10218	Metric Wheel Stud M22- 1-1/2" x 3-31/32"	.912-.908"	Wheel	10.9
WE10219	Metric Wheel Stud M22- 1-1/2" x 4-1/2"	.912-.908"	Wheel	10.9
WE10220	Metric Wheel Stud M22- 1-1/2" x 5"	.912-.908"	Wheel	10.9
WE10221	Metric Wheel Stud M22- 1-1/2" x 5-5/16"	.912-.908"	Wheel	10.9
WE10222	Metric Wheel Stud M22- 1-1/2" x 3-21/32"	.912-.908"	Wheel	10.9

Part No.	Description	Body Diameter	Type	Grade
WE10223	Metric Wheel Stud M22- 1-1/2" x 4-5/32"	.912-.908"	Wheel	10.9
WE10675	Metric Wheel Stud M22- 1-1/2" x 3-23/32"	.975-.971"	Wheel	10.9
WE10676	Metric Wheel Stud M22- 1-1/2" x 4-1/4"	.975-.971"	Wheel	10.9
WE12016	Metric Wheel Stud M22- 1-1/2" x 4-9/16"	.912-.908"	Wheel	10.9

WHEEL STUDS (SAE)



WE4966R

Table 7-162: Wheel End - Wheel Studs (SAE)

Part No.	Description	Body Diameter	Type	Grade
WE1090L	Left Hand Wheel Stud 1-1/8"-16 x 3-9/32"	1.222-1.218"	Wheel LH	8
WE1090R	Right Hand Wheel Stud 1-1/8"-16 x 3-9/32"	1.222-1.218"	Wheel RH	8
WE1320L	Left Hand Wheel Stud 3/4"-16 x 2-3/8"	.786 - .783"	Wheel LH	8
WE1320R	Right Hand Wheel Stud 3/4"-16 x 2-3/8"	.786 - .783"	Wheel RH	8
WE1339L	Left Hand Wheel Stud 3/4"-16 x 3-1/8"	.786 - .783"	Wheel LH	8
WE1339R	Right Hand Wheel Stud 3/4"-16 x 3-1/8"	.786 - .783"	Wheel RH	8
WE4966L	Left Hand Wheel Stud 3/4"-16 x 2-5/8"	.786 - .783"	Wheel LH	8
WE4966R	Right Hand Wheel Stud 3/4"-16 x 2-5/8"	.786 - .783"	Wheel RH	8
WE4967L	Left Hand Wheel Stud 3/4"-16 x 2-7/8"	n/a	Wheel LH	8
WE4967R	Right Hand Wheel Stud 3/4"-16 x 2-7/8"	n/a	Wheel RH	8
WE4969L	Left Hand Wheel Stud 3/4"-16 x 3-1/8"	.786 - .783"	Wheel LH	8
WE4969R	Right Hand Wheel Stud 3/4"-16 x 3-1/8"	.786 - .783"	Wheel RH	8
WE5722L	Left Hand Wheel Stud 3/4"-16 x 4"	.976 - .971"	Wheel LH	8
WE5722R	Right Hand Wheel Stud 3/4"-16 x 4"	.976 - .971"	Wheel RH	8
WE5766L	Left Hand Wheel Stud 3/4"-16 x 3-7/8"	.786 - .783"	Wheel LH	8
WE5766R	Right Hand Wheel Stud 3/4"-16 x 3-7/8"	.786 - .783"	Wheel RH	8
WE5870L	Left Hand Wheel Stud 3/4"-16 x 2-7/8"	.786 - .783"	Wheel LH	8
WE5870R	Right Hand Wheel Stud 3/4"-16 x 2-7/8"	.786 - .783"	Wheel RH	8
WE5871L	Left Hand Wheel Stud 3/4"-16 x 3-1/8"	.976 - .971"	Wheel LH	8
WE5871R	Right Hand Wheel Stud 3/4"-16 x 3-1/8"	.976 - .971"	Wheel RH	8
WE8947L	Left Hand Wheel Stud 3/4"-16 x 2-31/32"	.786 - .783"	Wheel LH	8
WE8947R	Right Hand Wheel Stud 3/4"-16 x 2-31/32"	.786 - .783"	Wheel RH	8

Part No.	Description	Body Diameter	Type	Grade
WE8949L	Left Hand Wheel Stud 3/4"-16 x 2-19/32"	.786 - .783"	Wheel LH	8
WE8949R	Right Hand Wheel Stud 3/4"-16 x 2-19/32"	.786 - .783"	Wheel RH	8
WE8969L	Left Hand Wheel Stud 3/4"-16 x 2-15/16"	.786 - .783"	Wheel LH	8
WE8969R	Right Hand Wheel Stud 3/4"-16 x 2-15/16"	.786 - .783"	Wheel RH	8
WE8979L	Left Hand Wheel Stud 3/4"-16 x 3-3/8"	.786 - .783"	Wheel LH	8
WE8979R	Right Hand Wheel Stud 3/4"-16 x 3-3/8"	.786 - .783"	Wheel RH	8
WE8983L	Left Hand Wheel Stud 3/4"-16 x 2-11/16"	.786 - .783"	Wheel LH	8
WE8983R	Right Hand Wheel Stud 3/4"-16 x 2-11/16"	.786 - .783"	Wheel RH	8
WE8985L	Left Hand Wheel Stud 1-1/8"-16 x 3-13/16"	1.222-1.218"	Wheel LH	8
WE8985R	Right Hand Wheel Stud 1-1/8"-16 x 3-13/16"	1.222-1.218"	Wheel RH	8
WE10208L	Left Hand Wheel Stud 3/4"-16 x 3-13/32"	.787 - .783"	Wheel LH	8
WE10208R	Right Hand Wheel Stud 3/4"-16 x 3-13/32"	.787 - .783"	Wheel RH	8
WE10209L	Left Hand Wheel Stud 3/4"-16 x 3-5/32"	.787 - .783"	Wheel LH	8
WE10209R	Right Hand Wheel Stud 3/4"-16 x 3-5/32"	.787 - .783"	Wheel RH	8
WE10210L	Left Hand Wheel Stud 3/4"-16 x 3-25/32"	.787 - .783"	Wheel LH	8
WE10210R	Right Hand Wheel Stud 3/4"-16 x 3-25/32"	.787 - .783"	Wheel RH	8
WE10225L	Left Hand Wheel Stud 1-1/8"-16 x 3-7/8"	1.225-1.221"	Wheel LH	8
WE10225R	Right Hand Wheel Stud 1-1/8"-16 x 3-7/8"	1.225-1.221"	Wheel RH	8
WE10227L	Left Hand Wheel Stud 1-1/8"-16 x 3-3/32"	1.225-1.221"	Wheel LH	8
WE10227R	Right Hand Wheel Stud 1-1/8"-16 x 3-3/32"	1.225-1.221"	Wheel RH	8
WE10228L	Left Hand Wheel Stud 1-1/8"-16 x 3-9/16"	1.225-1.221"	Wheel LH	8
WE10228R	Right Hand Wheel Stud 1-1/8"-16 x 3-9/16"	1.225-1.221"	Wheel RH	8

WHEEL STUDS WITH SHOULDER



WE5561R



WE5989L

Table 7-163: Wheel End - Wheel Studs with Shoulder

Part No.	Description	Body Diameter	Type	Grade
WE5556L	Left Hand Wheel Stud with Shoulder 3/4"-16 x 3-19/32"	.786 - .783"	Shoulder	8
WE5556R	Right Hand Wheel Stud with Shoulder 3/4"-16 x 3-19/32"	.786 - .783"	Shoulder	8
WE5559L	Left Hand Wheel Stud with Shoulder 3/4"-16 x 3-23/32"	.786 - .783"	Shoulder	8
WE5559R	Right Hand Wheel Stud with Shoulder 3/4"-16 x 3-23/32"	.786 - .783"	Shoulder	8
WE5561L	Left Hand Wheel Stud with Shoulder 3/4"-16 x 3-31/32"	.786 - .783"	Shoulder	8
WE5561R	Right Hand Wheel Stud with Shoulder 3/4"-16 x 3-31/32"	.786 - .783"	Shoulder	8
WE5560L	Left Hand Wheel Stud with Shoulder 3/4"-16 x 4-1/32"	.786 - .783"	Shoulder	8
WE5560R	Right Hand Wheel Stud with Shoulder 3/4"-16 x 4-1/32"	.786 - .783"	Shoulder	8
WE5989L	Left Hand Wheel Stud with Shoulder 3/4"-16 x 4-15/16"	.786 - .783"	Shoulder	8
WE5989R	Right Hand Wheel Stud with Shoulder 3/4"-16 x 4-15/16"	.786 - .783"	Shoulder	8
WE8976L	Left Hand Wheel Stud with Shoulder Hub End 3/4"-16 x 3-5/8"	1.222-1.218"	Shoulder	8
WE8976R	Right Hand Wheel Stud with Shoulder Hub End 3/4"-16 x 3-5/8"	1.222-1.218"	Shoulder	8

ASSORTED WHEEL STUDS



WE5924L



WE6030



WE6059R

Table 7-164: Wheel End - Assorted Wheel Studs

Part No.	Description	Body Diameter	Type	Grade
WE2193	Left Hand Headed Wheel Stud 3/4"-16 x 3-1/32"	.787 - .783"	Headed	8
WE3122	Wheel Flange Stud 5/8"-11 x 1-3/8" - 5/8-18 x 1-5/16"	n/a	Flange Stud	8
WE4956	Wheel Rim Stud 3/4"-10 x 2-13/16" (1" & 1-9/16")	n/a	Rim stud	8
WE5872	Wheel Flange Stud 5/8"-11 x 3-11/16"	n/a	Flange Stud	8
WE5924L	Left Hand Wedge Head Wheel Stud 3/4"-16 x 3-3/8"	.789 - .786"	Wedge head	8
WE5924R	Right Hand Wedge Head Wheel Stud 3/4"-16 x 3-3/8"	.789 - .786"	Wedge head	8
WE6001	Metric Wheel Clipped Head Stud M22- 1-1/2" x 4-15/16"	.912-.908"	Clipped head	10.9
WE6027L	Left Hand Wheel Clipped Head Stud 3/4"-16 x 3-3/8"	.786 - .783"	Clipped head	8
WE6027R	Right Hand Wheel Clipped Head Stud 3/4"-16 x 3-3/8"	.786 - .783"	Clipped head	8
WE6030	Metric Wheel Clipped Head Stud M22 - 1-1/2" x 5-1/4"	.912-.908"	Clipped head	10.9
WE6058L	Left Hand Wheel Clipped Head Stud 3/4"-16 x 3-1/4"	.786 - .783"	Clipped head	8
WE6058R	Right Hand Wheel Clipped Head Stud 3/4"-16 x 3-1/4"	.786 - .783"	Clipped head	8
WE6059L	Left Hand Wheel Clipped Head Stud 3/4"-16 x 3-1/2"	.786 - .783"	Clipped head	8
WE6059R	Right Hand Wheel Clipped Head Stud 3/4"-16 x 3-1/2"	.786 - .783"	Clipped head	8
WE10226L	Left Hand Steering Wheel Stud 3-13/32" x 1-1/2" x 1-31/32"	n/a	Steering Stud LH	8
WE10226R	Right Hand Steering Wheel Stud 3-13/32" x 1-1/2" x 1-31/32"	n/a	Steering Stud RH	8

ASSORTED WHEEL NUTS



Table 7-165: Wheel End - Assorted Wheel Nuts

Part No.	Description	Body Diameter	Type	Grade
WE4963	Wheel Rim Nut 3/4"-10	1-1/4"	Rim Nut	5
WE5991	Wheel Nut with Flange M22- 1-1/2"	1-1/2"	Flange	10.9
WE6000	Wheel Nut with Flange M22- 1-1/2"	1-3/10"	Flange	8
WE9020	Wheel Nut with Flange M22- 1-1/2"	1-3/10"	Flange	8

OUTER DISC WHEEL NUTS



Table 7-166: Wheel End - Outer Disc Wheel Nuts

Part No.	Description	Body Diameter	Type	Grade
WE5554L	Left Hand Outer Disc Wheel Nut 3/4"-16	1-1/2"	Outer Disc Wheel	8
WE5554R	Right Hand Outer Disc Wheel Nut 3/4"-16	1-1/2"	Outer Disc Wheel	8
WE5576L	Left Hand Outer Disc Wheel Nut 1-5/16"-12	1-3/4"	Outer Disc Wheel	8
WE5576R	Right Hand Outer Disc Wheel Nut 1-5/16"-12	1-3/4"	Outer Disc Wheel	8
WE5995L	Left Hand Outer Disc Wheel Nut 3/4"-16	1-1/2"	Outer Disc Wheel	8
WE5995R	Right Hand Outer Disc Wheel Nut 3/4"-16	1-1/2"	Outer Disc Wheel	8

OUTER WHEEL NUTS



WE6060L

Table 7-167: Wheel End - Outer Wheel Nuts

Part No.	Description	Body Diameter	Type	Grade
WE5652L	Left Hand Outer Wheel Nut 3/4"-16	1-1/2"	Outer Wheel LH	5
WE5652R	Right Hand Outer Wheel Nut 3/4"-16	1-1/2"	Outer Wheel RH	5
WE5977L	Left Hand Outer Wheel Nut 1-1/8"-16	1-1/2"	Outer Wheel LH	8
WE5977R	Right Hand Outer Wheel Nut 1-1/8"-16	1-1/2"	Outer Wheel RH	8
WE5996L	Left Hand Outer Wheel Nut 1-1/8"-16	1-1/2"	Outer Wheel LH	8
WE5996R	Right Hand Outer Wheel Nut 1-1/8"-16	1-1/2"	Outer Wheel RH	8
WE6060L	Left Hand Outer Wheel Nut 1-1/8"-16	1-3/4"	Outer Wheel LH	8
WE6060R	Right Hand Outer Wheel Nut 1-1/8"-16	1-3/4"	Outer Wheel RH	8

WHEEL NUTS



WE7897R

WE7895R

WE7896R

Table 7-168: Wheel End - Wheel Nuts

Part No.	Description	Type	Grade
WE5978L	Left Hand Wheel Nut (I- 3/4"-16) (O- 1-1/8"-16) x 3-1/16"	LH	8
WE5978R	Right Hand Wheel Nut (I- 3/4"-16) (O- 1-1/8"-16) x 3-1/16"	RH	8
WE5988L	Left Hand Wheel Nut (I- 3/4"-16) (O- 1-1/8"-16) x 3-1/16"	LH	8
WE5988R	Right Hand Wheel Nut (I- 3/4"-16) (O- 1-1/8"-16) x 3-1/16"	RH	8
WE7895L	Left Hand Wheel Nut (I- 3/4"-16) (O- 1-1/8"-16) x 2-1/4"	LH	8
WE7895R	Right Hand Wheel Nut (I- 3/4"-16) (O- 1-1/8"-16) x 2-1/4"	RH	8
WE7896L	Left Hand Wheel Nut (I- 3/4"-16) (O- 1-1/8"-16) x 2-9/16"	LH	8
WE7896R	Right Hand Wheel Nut (I- 3/4"-16) (O- 1-1/8"-16) x 2-9/16"	RH	8
WE7897L	Left Hand Wheel Nut (I- 3/4"-16) (O- 1-1/8"-16) x 3-1/16"	LH	8
WE7897R	Right Hand Wheel Nut (I- 3/4"-16) (O- 1-1/8"-16) x 3-1/16"	RH	8
WE7898L	Left Hand Wheel Nut (I- 15/16"-12) (O- 1-5/16"-12) x 3"	LH	8
WE7898R	Right Hand Wheel Nut (I- 15/16"-12) (O- 1-5/16"-12) x 3"	RH	8

CROSS REFERENCE FOR WHEEL END HARDWARE

CROSS REFERENCE FOR WHEEL END HARDWARE

Table 7-169: Cross Reference
for Wheel End Hardware

Part No.	Leland Part No.
L1529	WE5872
L3122	WE3122
W11/ W11P	WE7895R
W12/ W12P	WE7895L
W122	WE5554R
W123	WE5554L
W13/ W13P	WE5977R
W14/ W14P	WE5977L
W15/ W15P	WE5652R
W154	WE5576R
W155	WE5576L
W16/ W16P	WE5652L
W160	WE7898R
W161	WE7898L
W166	WE5720R
W167	WE5720L
W170	WE5719R
W171	WE5719L
W264	WE5924R
W265	WE5924L
W274	WE5871R
W275	WE5871L
W276	WE5896R
W277	WE5896L
W280	WE5766R
W281	WE5766L

Part No.	Leland Part No.
W330	WE9001R
W331	WE9001L
W370	WE5722R
W371	WE5722L
W38	WE5556R
W39	WE5556L
W395	WE5910R
W396	WE5910L
W399	WE5900R
W40	WE5559R
W400	WE5900L
W41	WE5559L
W42	WE5561R
W426	WE6060R
W427	WE6060L
W43	WE5561L
W44	WE5560R
W45	WE5560L
W475	WE5983R
W476	WE5983L
W477	WE5982R
W478	WE5982L
W486/ W486P	WE5988R
W487/ W487P	WE5988L
W492	WE5991
W495	WE5999
W496	WE5998
W497	WE5997
W498/ W498P	WE6000
W500	WE5989R
W501	WE5989L
W504	WE8949R
W505	WE8949L
W506	WE5995R
W507	WE5995L
W508	WE5996R
W509	WE5996L

Part No.	Leland Part No.
W510	WE8972R
W511	WE8972L
W520	WE5986R
W521	WE5986L
W524	WE6030
W525	WE9020
W526	WE6058R
W527	WE6058L
W528	WE6059R
W529	WE6059L
W542	WE6027R
W543	WE6027L
W544	WE6036
W545	WE6035
W546	WE1325
W546	WE6034
W547	WE6001
W550	WE8990R
W551	WE8990L
W575	WE8947R
W576	WE8947L
W6/ W6P	WE4956
W608	WE8969R
W609	WE8969L
W610	WE8979R
W611	WE8979L
W616	WE7897R
W617	WE7897L
W620/ W620P	WE7896R
W621/ W621P	WE7896L
W640	WE8976R
W641	WE8976L
W648	WE10206R
W649	WE10206L
W657	WE8981
W66	WE4966R
W662	WE10225R

Part No.	Leland Part No.	Part No.	Leland Part No.
W663	WE10225L	W753	WE1320L
W669	WE10676	W754	WE1339R
W67	WE4966L	W755	WE1339L
W674	WE8968R	W756	WE10228R
W675	WE8968L	W757	WE10228L
W678	WE10675	W766	WE5978R
W678	WE8988	W767	WE5978L
W68	WE4967R	W771	WE10223
W680	WE8983R	W772	WE10222
W681	WE8983L	W774	WE10227R
W683	WE1202	W775	WE10227L
W688	WE8987	W778	WE10226R
W69	WE4967L	W779	WE10226L
W70	WE5870R	W8/ W8P	WE4963
W702	WE10221		
W703	WE10218		
W706	WE10208R		
W707	WE10208L		
W708	WE10219		
W71	WE5870L		
W710	WE8985R		
W711	WE8985L		
W715	WE1270		
W716	WE10215		
W717	WE12016		
W718	WE10217		
W719	WE10220		
W72	WE4969R		
W727	WE2193		
W728	WE10209R		
W729	WE10209L		
W73	WE4969L		
W730	WE10210R		
W731	WE10210L		
W750	WE1090R		
W751	WE1090L		
W752	WE1320R		



SEALS

FEATURES & BENEFITS

- " Metal-to-metal contact between seal O.D. and hub bore for a tight fit and long life.
- " Completely comparable and interchangeable with major seal brands to eliminate need for duplicate stocking.
- " Independently tested in the U.S. to confirm equal performance and durability with recognized brands.
- " Installs with standard tooling for ease of servicing.



WHEEL SEALS

TRP® oil bath seals are specialized oil bath seals designed for bus, truck, and tractor axles. Four basic unitized one-piece designs featuring metal or Nitrile-covered O.D. with ground surface and front chamfer will be offered, each interchangeable with industry standard specifications.

The TRP® one-piece design enables efficient service with one-step installation. The seals are designed to keep contaminants at a distance, while lubrication of the rubber lip remains intact, decreasing friction and increasing seal life.

POPULAR TRAILER APPLICATION WHEEL SEALS

TRP®	Axle Model	Shaft	Bore	Seal O.D.	Width	Lip Material
SW42623	Fruehauf, Rockwell (TP Series)	4.25	6.009	6.014	0.984	Nitrile
SW46305	Dana, Rockwell	4.625	6.001	6.006	1.063	Nitrile
SW370025A	Dana, Rockwell	4.625	5.999	6.008	0.84	Nitrile
SW370065A	Fruehauf, Rockwell (TP Series)	4.25	6.008	6.022	1	Nitrile

POPULAR TRACTOR APPLICATION WHEEL SEALS

TRP®	Axle Model	Shaft	Bore	Seal O.D.	Width	Lip Material
SW35066	Front Axle – All Makes	3.5	4.842	4.847	0.904	Nitrile
SW38780	Drive Axle – Ford, Navistar, Volvo	3.875	5.691	5.696	0.938	Nitrile
SW42672	Drive Axle – Mack	4.25	6.254	6.259	1.25	Nitrile
SW47697	Drive Axle – All Makes	4.766	6.311	6.316	1.125	Nitrile
SW370001A	Front Axle – All Makes	3.5	4.842	4.848	0.925	Nitrile
SW370003A	Drive Axle – All Makes	4.765	6.311	6.318	1.078	Nitrile
SW370023A	Drive Axle – Ford, Navistar, Volvo	3.875	5.69	5.706	0.875	Nitrile



Scan the code for more information.
Get the free mobile app at <http://gettag.mobi>

WHEEL SEALS

Trailer Leaf Springs

See Page 7-278



DRIVE AXLE WHEEL SEALS



Table 7-170: Wheel End - Drive Axle Seals

Part No.	Description	Shaft	Bore	O.D.	Width
SW35059	Front Wheel Axle Seal, Nitrile	3.5" (88.9mm)	4.842" (122.987mm)	4.854" (123.292mm)	0.903" (22.936mm)
SW35066	Front Wheel Axle Seal, Nitrile	3.5" (88.9mm)	4.842" (122.987mm)	4.847" (123.114mm)	0.904" (22.962mm)
SW370001A	Front Wheel Axle Seal, Nitrile	3.5" (88.9mm)	4.842" (122.987mm)	4.848" (123.139mm)	0.925" (23.495mm)
SW370003A	Drive Axle Wheel Seal, Nitrile	4.765" (121.031mm)	6.311" (160.299mm)	6.318" (160.477mm)	1.078" (27.381mm)
SW370005A	Drive Axle Wheel Seal, Nitrile	4.765" (121.031mm)	6.251" (158.775mm)	6.265" (159.131mm)	0.605" (15.367mm)
SW370023A	Drive Axle Wheel Seal, Nitrile	3.875" (98.425mm)	5.69" (144.526mm)	5.706" (144.932mm)	0.875" (22.225mm)
SW370069A	Drive Axle Wheel Seal, Nitrile	5.25" (133.35mm)	7.375" (187.325mm)	7.386" (187.604mm)	1" (25.4mm)
SW38780	Drive Axle Wheel Seal, Nitrile	3.875" (98.425mm)	5.691" (144.551mm)	5.696" (144.678mm)	0.938" (23.825mm)
SW42672	Drive Axle Wheel Seal, Nitrile	4.25" (107.95mm)	6.254" (158.852mm)	6.259" (158.979mm)	1.25" (31.75mm)
SW45160	Drive Axle Wheel Seal, Nitrile	4.5" (114.3mm)	6.254" (158.852mm)	6.259" (158.979mm)	1.047" (26.594mm)
SW47695	Drive Axle Wheel Seal, Nitrile	4.767" (121.082mm)	6.308" (160.223mm)	6.326" (160.68mm)	1.42" (36.068mm)
SW47697	Drive Axle Wheel Seal, Nitrile	4.766" (121.056mm)	6.311" (160.299mm)	6.316" (160.426mm)	1.125" (28.575mm)

FRONT AXLE WHEEL SEALS

Table 7-171: Wheel End - Front Axle Wheel Seals

Part No.	Description	Shaft	Bore	O.D.	Width
SW35059	Front Axle Wheel Seal, Nitrile	3.5" (88.9mm)	4.842" (122.987mm)	4.854" (123.292mm)	0.903" (22.936mm)
SW35066	Front Axle Wheel Seal, Nitrile	3.5" (88.9mm)	4.842" (122.987mm)	4.847" (123.114mm)	0.904" (22.962mm)
SW370001A	Front Axle Wheel Seal, Nitrile	3.5" (88.9mm)	4.842" (122.987mm)	4.848" (123.139mm)	0.925" (23.495mm)

TRAILER AXLE WHEEL SEALS

Table 7-172: Wheel End - Trailer
Axle Wheel Seals

Part No.	Description	Shaft	Bore	O.D.	Width
SW40136	Trailer Axle Wheel Seal, Nitrile	4" (101.6mm)	5.754" (146.152mm)	5.759" (146.279mm)	1.079" (27.407mm)
SW42622	Trailer Axle Wheel Seal, Nitrile, TP Series	4.25" (107.95mm)	6.009" (152.629mm)	6.025" (153.035mm)	0.971" (24.663mm)
SW42623	Trailer Axle Wheel Seal, Nitrile, TP Series	4.25" (107.95mm)	6.009" (152.629mm)	6.014" (152.756mm)	0.984" (24.994mm)
SW46305	Trailer Axle Wheel Seal, Nitrile	4.625" (117.475mm)	6.001" (152.425mm)	6.006" (152.552mm)	1.063" (27mm)
SW370025A	Trailer Axle Wheel Seal, Nitrile	4.625" (117.475mm)	5.999" (152.375mm)	6.008" (152.603mm)	0.84" (21.336mm)
SW370065A	Trailer Axle Wheel Seal, Nitrile, TP Series	4.25" (107.95mm)	6.008" (152.603mm)	6.022" (152.959mm)	1" (25.4mm)

NOTES

A large rectangular area filled with a light blue grid pattern, intended for handwritten notes.

NOTES

A large rectangular area filled with a light blue grid pattern, intended for handwritten notes.



*For information, updates, or corrections,
please contact us at support@trparts.com*

*No part of this marketing material may be
reproduced in any manner without written
permission from TRP® North America.*

TRP® North America

750 Houser Way N.
Renton, WA 98057

www.trpparts.com